

**POWER<sup>®</sup>  
QUEEN**

**Product Manual**

Power Queen



[www.ipowerqueen.com](http://www.ipowerqueen.com)

# MPPT

30A 12V/24V

**MAXIMUM POWER POINT TRACKING**

**SOLAR CHARGE AND DISCHARGE CONTROLLER**

 [service@ipowerqueen.com](mailto:service@ipowerqueen.com)

 [technicalsupport@ipowerqueen.com](mailto:technicalsupport@ipowerqueen.com)



Bluetooth APP Installation & Operation

# IMPORTANT SAFETY INSTRUCTIONS

---

Please read the following safety instructions carefully and perform installation and connection operations under the guidance of professionals.

This manual contains important safety, installation, and operating instructions for the MPPT charge controller. The following symbols are used in this manual to indicate potentially dangerous conditions or important safety information.

 **Warning:** Indicates that the operation in question is dangerous, and safety preparations must be made before operation.

 **Caution:** Indicates a critical procedure for safe and proper operation of the controller.

 **Note:** Indicates a procedure or function that is important to the safe and proper operation of the controller.

## General Safety Information

1. **Read all cautionary and safety instructions** in this manual before installation. If an operation needs to be done, be sure to **use insulation tools** and **keep hands dry**.
2. There are no parts inside the controller that require maintenance or repair, **DO NOT disassemble and try to repair the controller by yourself**.
3. Install the controller indoors to avoid potentially hazardous exposure and to **prevent water** from entering the controller.
4. Install the controller at a place **with good ventilation conditions** as the radiator may reach a very high temperature during operation.
5. After installation, **check whether all wiring connections are tight** and reliable to avoid the danger of heat accumulation caused by loose connections.

## **Battery Safety**

1. Carefully read battery manuals, and operate the battery according to the battery manufacturer's guidance.
2. To prevent the battery from being short-circuited, **NO** metal objects shall be placed near the battery, and **AVOID** touching the positive (+) and negative (-) terminals with bare hands.
3. Be very careful when installing lead-acid batteries. Wear eye protection and have fresh water available in case there is contact with the battery acid.
4. Explosive battery gases may be present while charging a lead-acid battery. Make sure there is enough ventilation to release the gases.
5. Keep the lead-acid battery away from fire sparks, as it may produce flammable gas.
6. Please set the correct battery type for the first use.

## **Charge Controller Safety**

1. Please completely **cover/cap** the **solar panels** during installation to **avoid generating current**. It is preferable to install a **DC circuit breaker** between solar panels and MPPT controller for safety reasons.
2. If grounding is required, please make sure to **ground the device on the negative**.
3. Please **DO NOT reverse connect** battery wires into the battery ports.

## **Warning:**

1. **NEVER** connect the solar panel array to the controller without a battery. **The battery must be connected first.**
2. Ensure input voltage **does not exceed 100 VDC** to prevent permanent damage to the controller.
3. **DO NOT** connect any **inverter, AC load, or battery charger** to the **load ports** of the charge controller.
4. We strongly recommend that **fuses or breakers be connected at the solar panel array side, load side, and battery side** to avoid electric shock during wiring operation or faulty operations and ensure the fuses and breakers **are in an open state before wiring**.

# PRODUCT OVERVIEW

## 📦 12V/24V 30A MPPT Solar Charge Controller

Default Battery Setting	12V LI (Lithium Iron Phosphate) Battery
System Voltage	12V/24V
Rated Charging Current	30A
Rated Load Current	20A
Max. Solar Panel System Input Power	450W for 12V / 900W for 24V

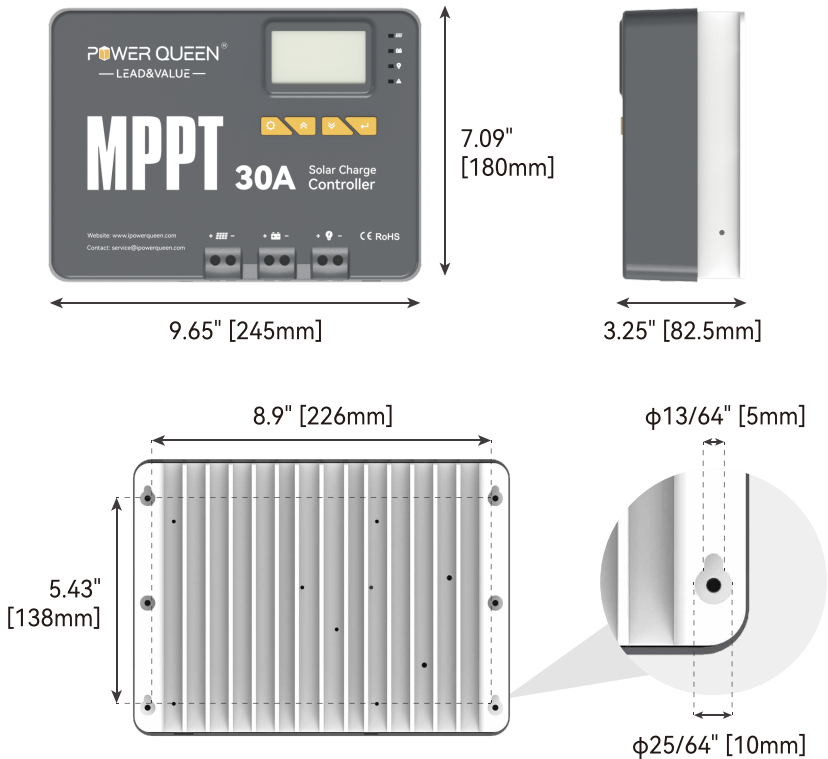

# ADDITIONAL COMPONENTS

Additional components are included in the package

## Remote Temperature Sensor for Lead-Acid Battery & Magic Sticker

This sensor measures the temperature of the battery and uses this data for very accurate temperature compensation. Simply connect the cable and attach the sensor with the sticker on the top or side of the battery to record the ambient temperature around the battery.

**Note:** DO NOT use this sensor when charging lithium battery.



Magic Sticker

## Copper Wire Connector \* 6

## Heat Shrink Tubing \* 6

Compatible size wire connectors and heat shrink tubing for connecting the devices to the controller. We recommend using the red heat shrink tubing on the positive terminals, and black on the negative.

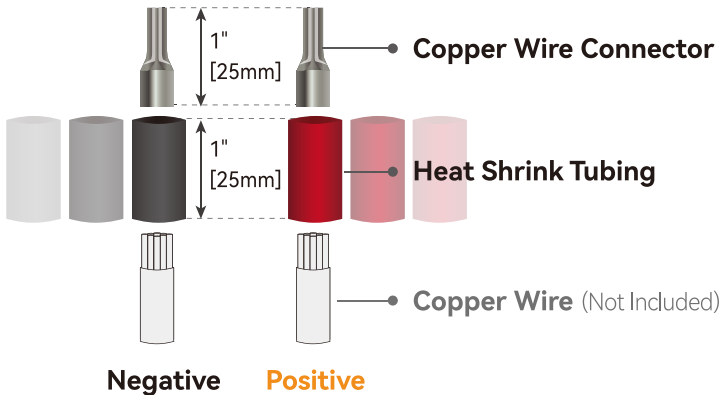

## Mounting Brackets \* 4 / Screws \* 8

These brackets can be used to mount the charge controller on any flat surface. Includes screws for mounting the bracket to the charge controller and for mounting the controller to a surface.

### Mounting Brackets

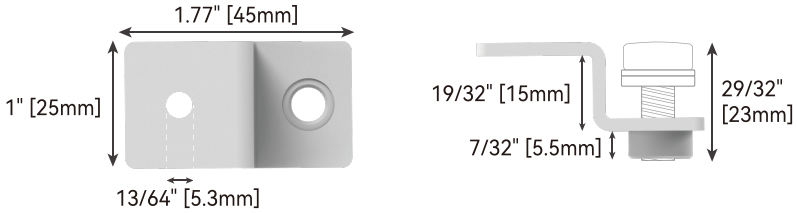

### Screws

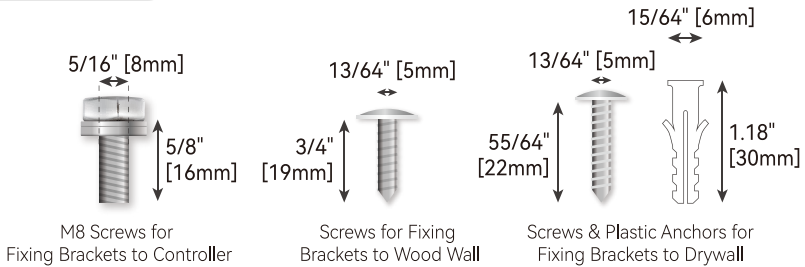

# Content

01

## IDENTIFICATION OF PARTS

02

## INSTALLATION

Page 02

Choose the Mounting Location

Page 02

Installation Method ① Using Mounting Hole

Page 04

Installation Method ② Using Mounting Brackets

06

## WIRING

Page 07

Step 1 Connect the Battery to the Controller

Page 08

Step 2 Connect the Load to the Controller (Optional)

Page 09

Step 3 Connect the Solar Panel to the Controller

Page 10

Step 4 Connect Bluetooth Module to the Controller (Optional)

Page 10

Step 5 Connect Temperature Sensor to the Controller (Optional for Lead-Acid Battery)

11

## OPERATION

Page 11

Startup Interface

Page 11

LCD Display

Page 13

Key Operations



Page 14	Switching of Displayed Information
Page 15	Programming System Voltage
Page 16	Programming Load Mode

## 17 **LED INDICATORS**

## 18 **BLUETOOTH INSTALLATION AND OPERATION**

Page 18	Bluetooth Connection
Page 18	Parameter Settings

## 19 **SPECIFICATIONS**

## 21 **BATTERY TYPES AND DEFAULT PARAMETERS**

## 23 **TROUBLESHOOTING**

## 25 **SYSTEM MAINTENANCE**

# IDENTIFICATION OF PARTS

---

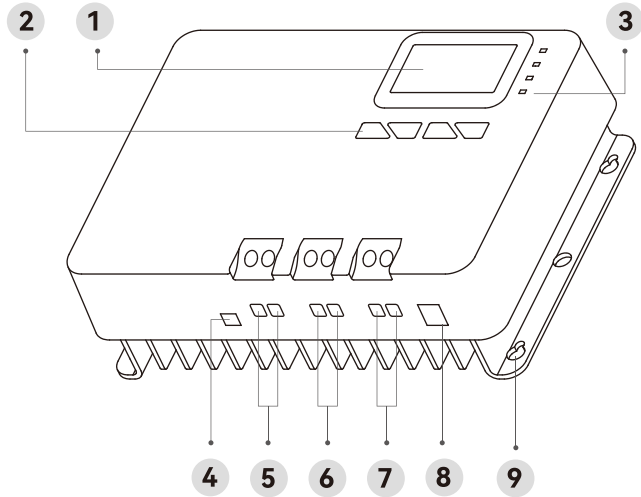

## No. Item

- 1 LCD Screen
- 2 Operating Keys
- 3 LED Indicators (PV/BAT/LOAD/FAULT)
- 4 Remote Temperature Sensor Port (For Lead-Acid Battery)
- 5 Solar Panel Terminals
- 6 Battery Terminals
- 7 DC Load Terminals
- 8 RS485 Communication Port (RJ12)
- 9 Mounting Holes

# INSTALLATION

**Warning:** Never install the controller in a sealed enclosure with flooded batteries. Gas can accumulate and there is a risk of explosion.

## Choose the Mounting Location

Choose a vertical surface protected from direct sunlight, high temperatures, and water. **Make sure there is good ventilation.**

Check the ventilation clearance above the controller for at least 3.94 inches (100mm) and below the controller for at least 7.87 inches (200mm).

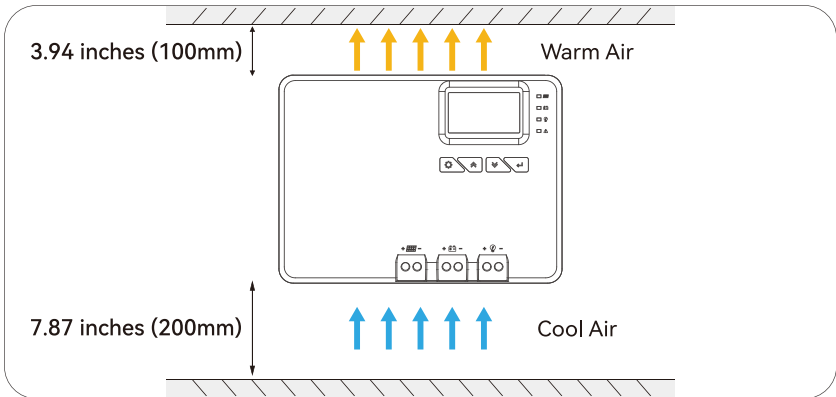

## Installation Method ① Using Mounting Hole

➤ Step 1

Mark Holes with the Installation Position Guide

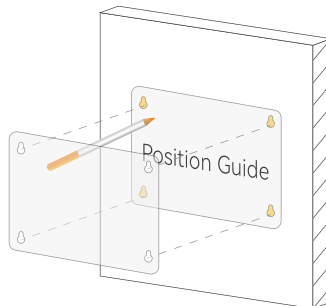

➤ Step 2

**Fix the Screws at the Marked Position**

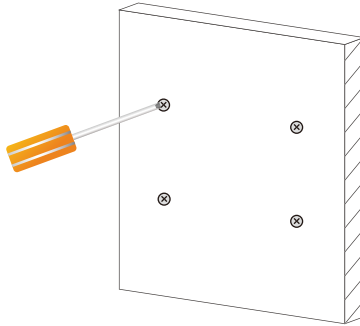

➤ Step 3

**Fix the Controller**

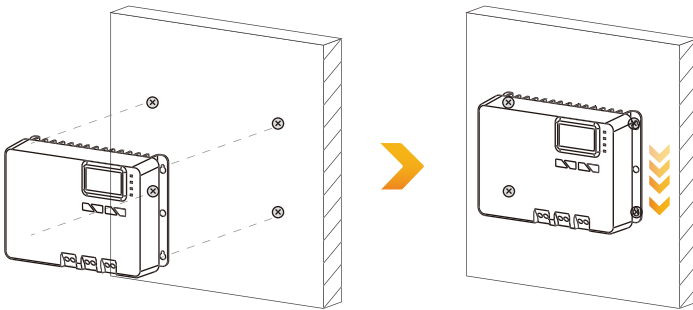

Align the controller mounting holes with the four pre-fixed screws in Step 2 and mount the controller on. Check if the mounting feels secure.

## Installation Method ② Using Mounting Brackets

### Step 1

### Install the Provided Brackets to the Controller

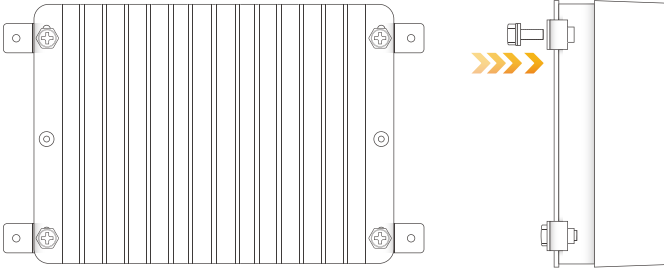

### Step 2

### Mark Holes with the Four Mounting Brackets

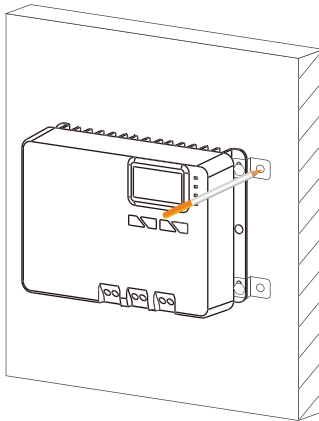

➤ Step 3

**Drill Holes and Insert the Plastic Anchors  
(Optional when Mounted on Drywall)**

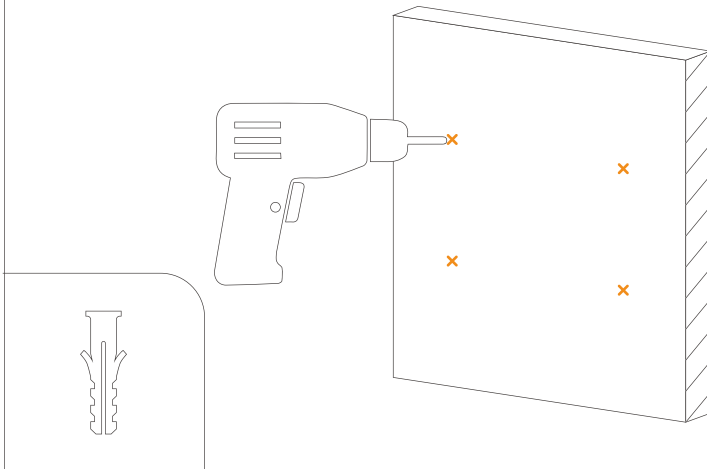

For drywall mounting, drill four  $\Phi 15/64"$  (6mm) mounting holes and insert the provided plastic anchors into the drilled holes.

➤ Step 4

**Fix the Screws to the Mounting Brackets**

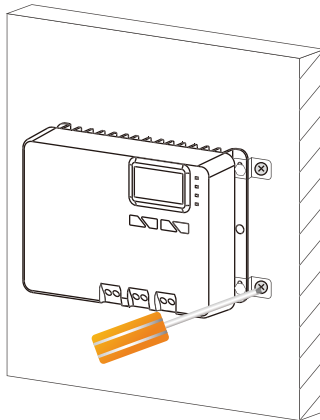

Use the appropriate screws based on the wall to be mounted and fix the screws to the mounting brackets. Check if the mounting feels secure.

# WIRING

---

**⚠ Warning:** We strongly recommend that **fuses or breakers be connected at** the **solar panel array** side, **load** side, and **battery** side so as to avoid electric shock during wiring operation or faulty operations, and make sure the fuses and breakers are **in an open state before wiring**.

**⚠ Warning:** **DO NOT** connect any **inverters, AC Loads, or battery chargers** to the **LOAD Ports** of the charge controller.

**⚡ Caution:** Do not over-tighten the screw terminals. This could potentially break the piece that holds the wire to the charge controller.

## Wire Gauge Recommendation

Solar Panel / Battery	8AWG
Load	10AWG
Max. Wire Gauge	8AWG

## Fuse Recommendation

(1.2 to 1.5 times the maximum continuous current)

Solar Panel / Battery	36A to 45A
Load	24A to 30A

You are now ready to complete the wiring starting with the connection of the battery to the charge controller.

**🗨 Note:** **Wear insulating gloves before the operation to prevent safety accidents.**

**🗨 Note:** Loosen screws and wiring terminals counterclockwise and tighten clockwise.

**🗨 Note:** Always connect the **positive terminal first** and then the negative.

## Step 1 Connect the Battery to the Controller

**Note:** The wire **connector needs to be placed on** the wiring terminal.

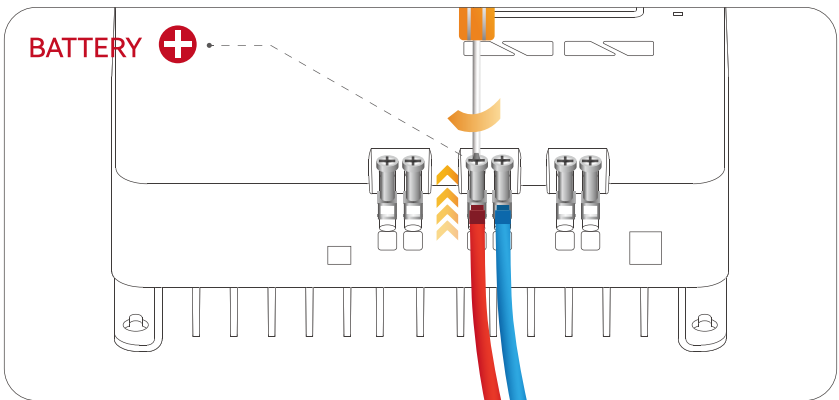
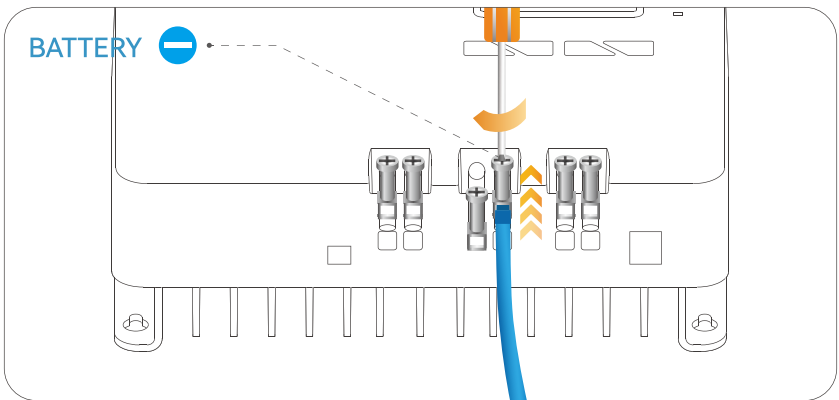
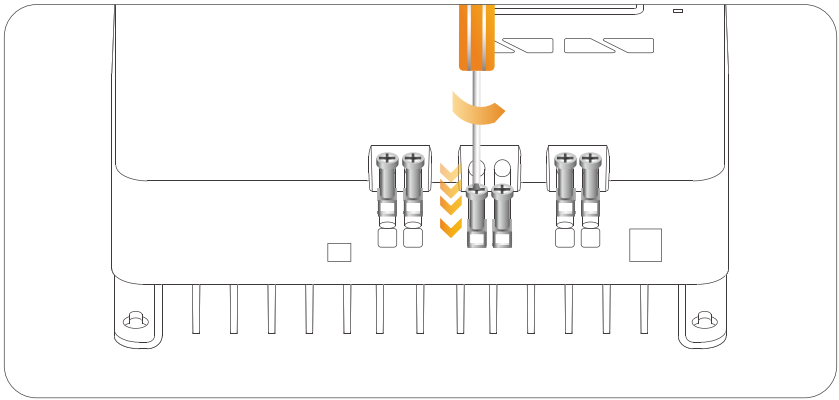



## Step 2 Connect the Load to the Controller (Optional)

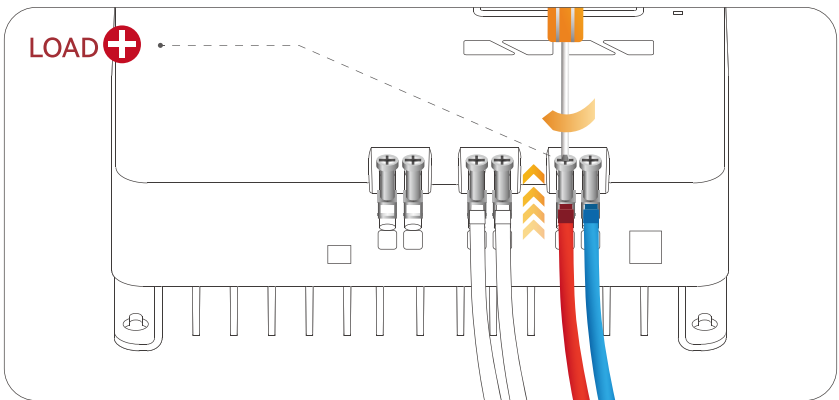
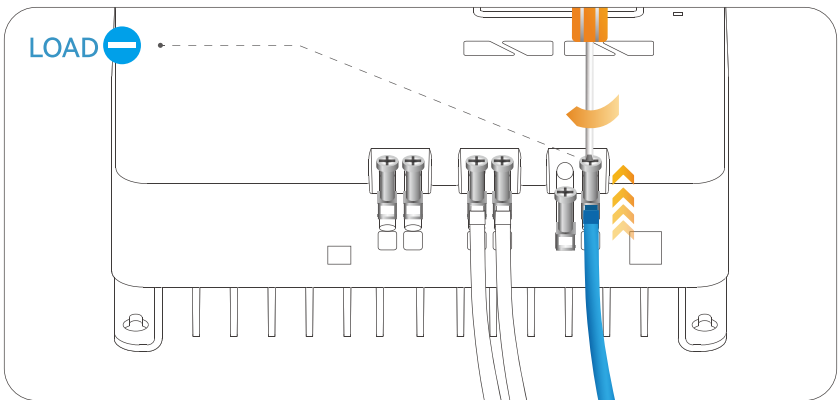
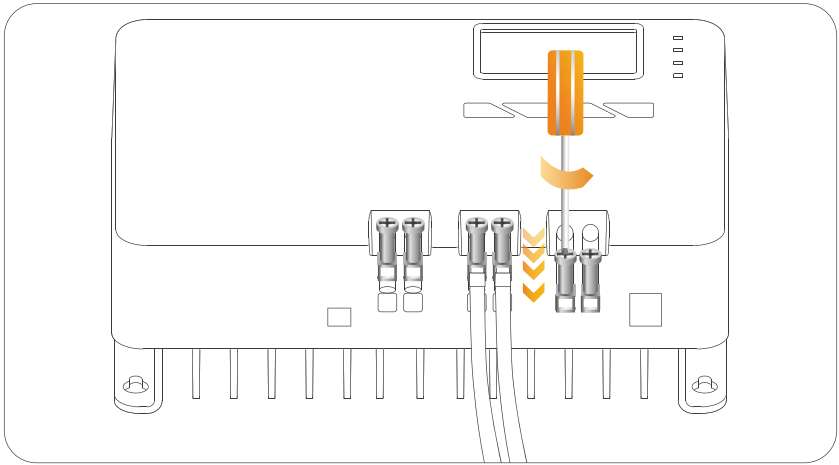

### Step 3 Connect the Solar Panel to the Controller

**⚠ Warning:** Danger of High Voltage! Be careful not to expose the solar panel array to any sunlight during installation, which can be avoided by flipping the solar panel array upside down to the ground.

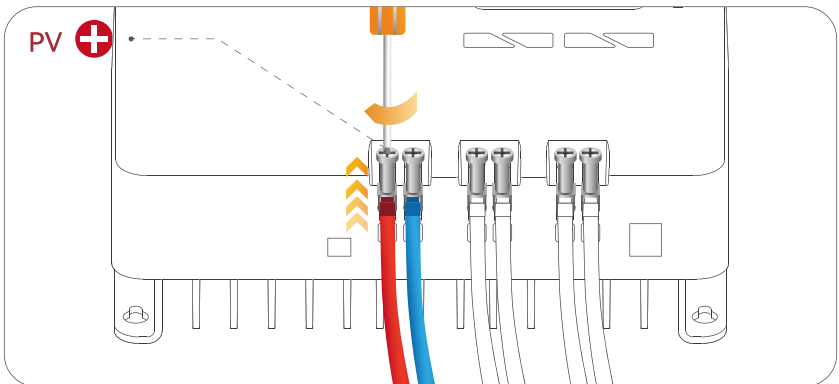
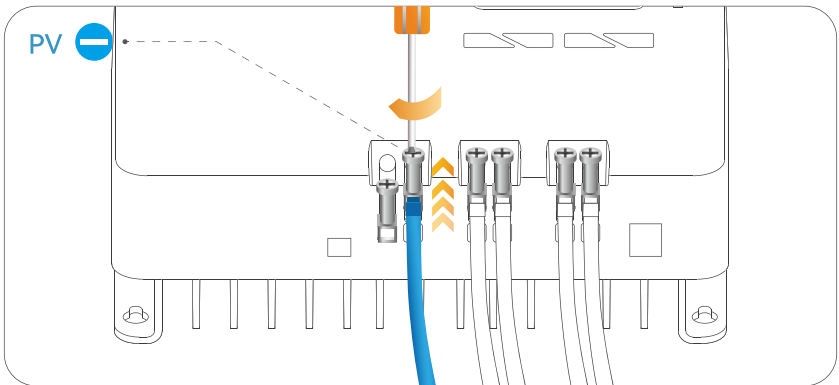
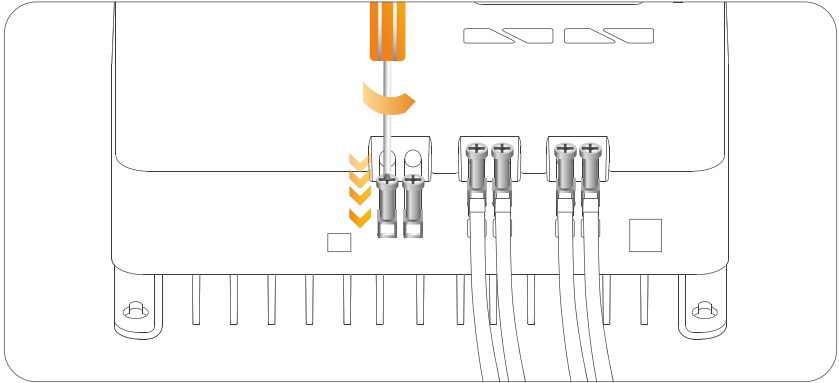

#### Step 4 Connect Bluetooth Module to the Controller (Optional)

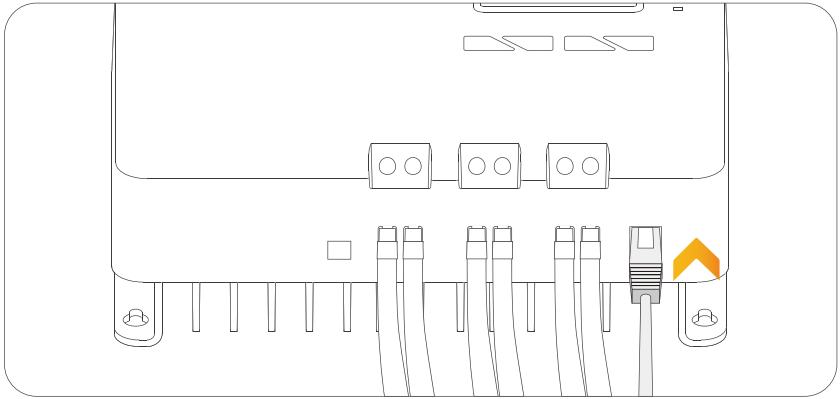

#### Step 5 Connect Temperature Sensor to the Controller (Optional for Lead-Acid Battery)

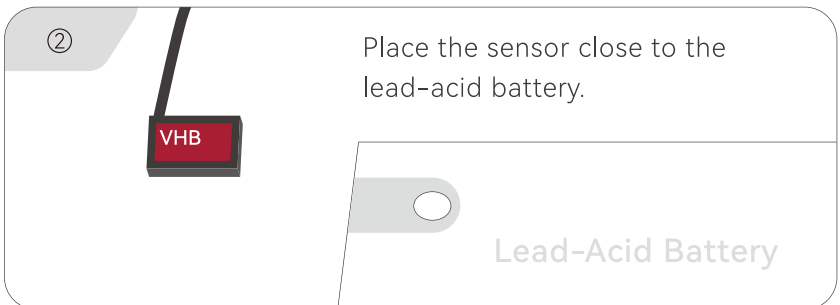
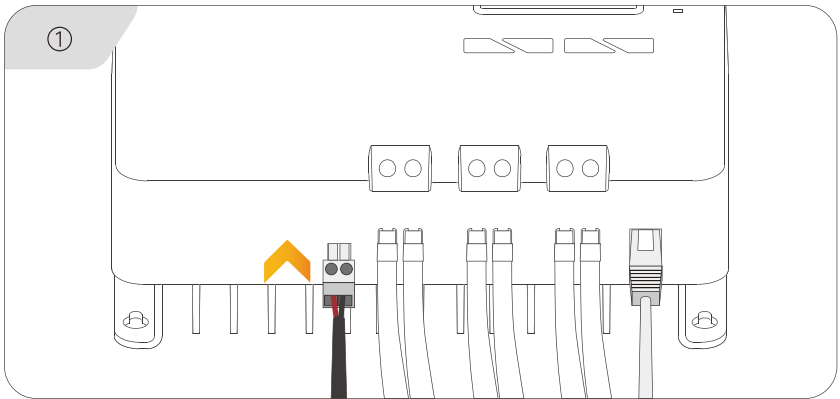

# OPERATION

The controller comes equipped with an LCD screen and 4 buttons to operate the menus.

**Note:** Please set the correct battery type for the first use if it is not 12V lithium battery as the default setting.

## STARTUP INTERFACE

During startup, the 4 LED indicators will first flash successively, and after self-inspection, the LCD screen starts and displays the main interface.

## LCD-DISPLAY

### Main Interface

The main interface displays the battery's voltage after starting up, and the system is set to **12V LiFePO4 battery mode by default.**

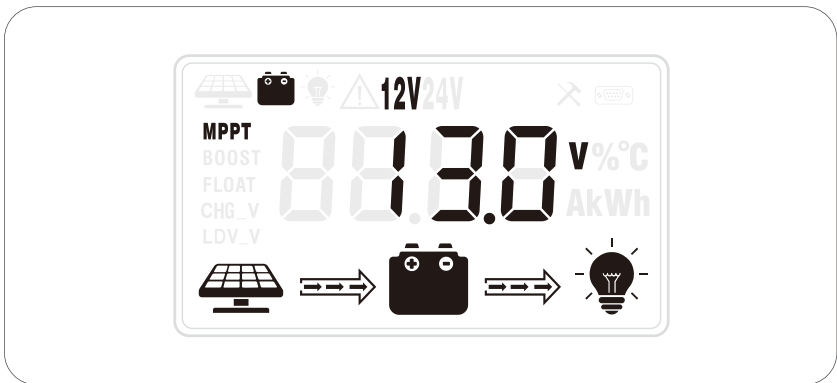

**Note:** If the voltage or battery type of the battery connected to the controller does not match the default system settings, the controller will report an error after startup. The controller will work normally after changing to the correct system settings (refer to the operations on page 15 to change the relevant settings).

## LCD Indicators

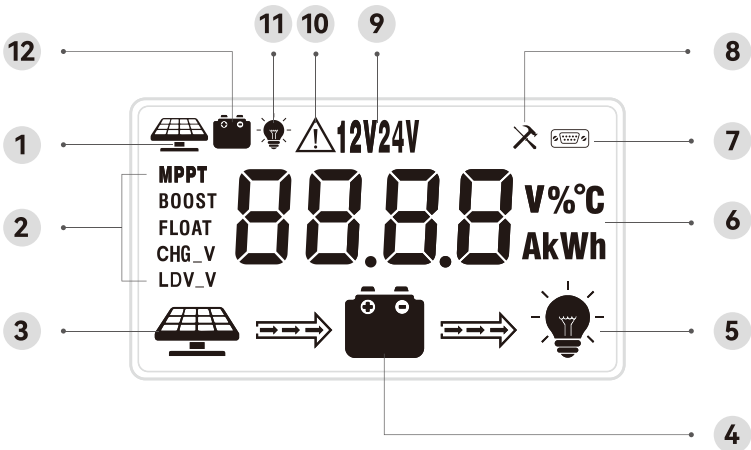





## No. Item





- 1** Solar Status
- 2** Charging Stage
- 3** Solar Charge
- 4** Battery
- 5** DC Load
- 6** Unit
- 7** Communication
- 8** Setting Interface
- 9** System Voltage
- 10** Error
- 11** DC Load Status
- 12** Battery Status

## KEY OPERATIONS

### In View Mode

Key	Operation	Function
 SET	Long Press	Enter Set Mode
 UP	Short Press	View Previous Page
 DOWN		View Next Page
 RETURN		DC Load On/OFF (Manual Control Mode Only)

### In Set Mode

Key	Operation	Function
 SET	Long Press	Save Data & Exit Set Mode
	Short Press	Next
 UP	Short Press	Increase Value
 DOWN		Decrease Value
 RETURN		Exit Set Mode without Saving

## SWITCHING OF DISPLAYED INFORMATION

The information displayed on the LCD interface in View Mode can be changed by short pressing the “UP” or “DOWN” key.

The displayed information will be changed in the following sequence.

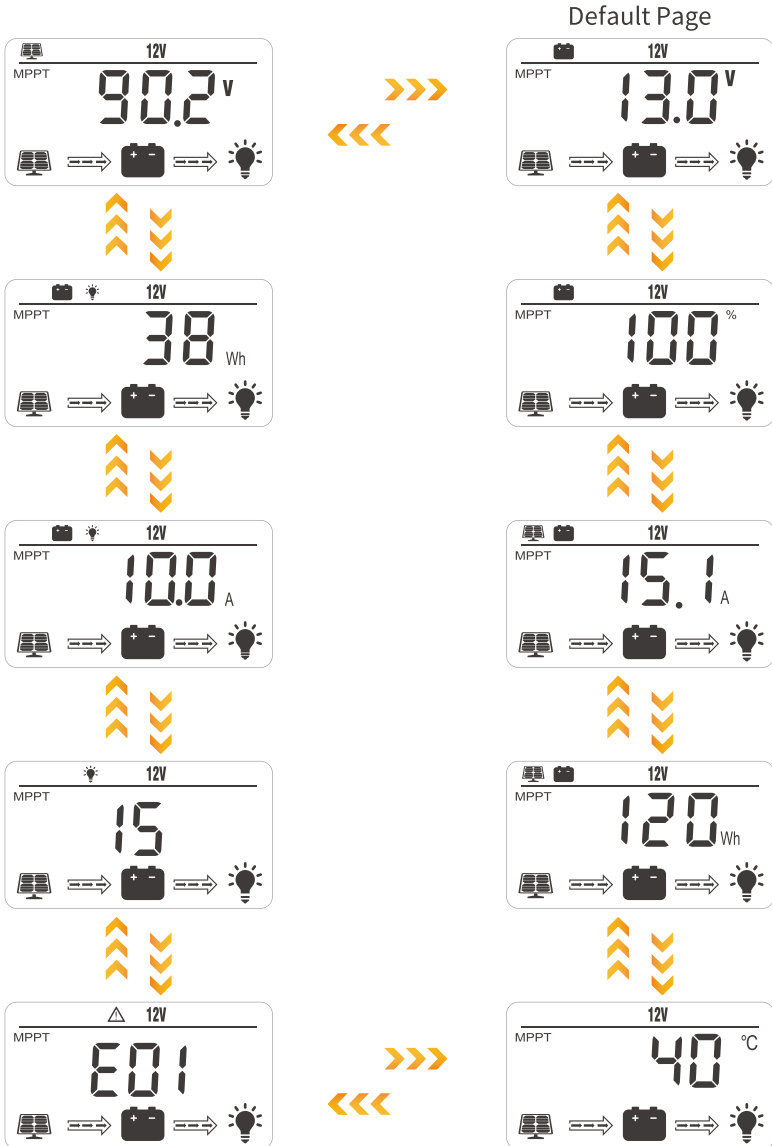

## PROGRAMMING SYSTEM VOLTAGE

### Step 1

### Enter the Setting

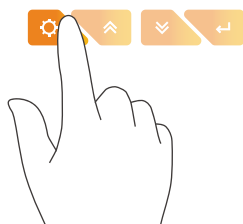

Long press **"SET"** in View Mode / any View page.

### Step 2

### Set the Battery Voltage

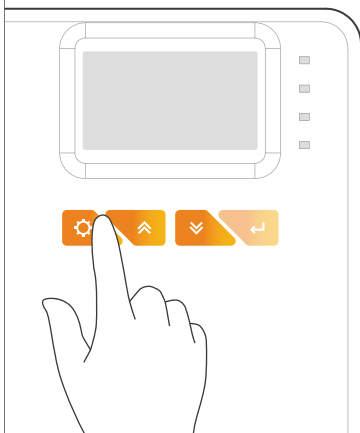

Battery Type: LI

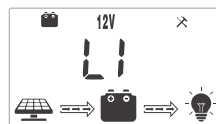

**SET** 

System Voltage

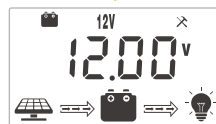

**DOWN** 

System Voltage

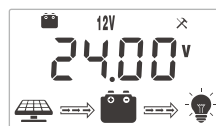

**Short press "SET"** again to enter the system voltage setting, **short press** the **"UP"** or **"DOWN"** to cycle through the battery voltage, then **long press** the **"SET"** key to complete the selection.

 **Note:** Selecting LI (LiFePO4) battery type requires locking the battery system voltage and cannot be selected for "AUTO" mode (automatic recognition of system voltage).



## PROGRAMMING LOAD MODE

The default load mode is the “Manual Mode” of code (15) (see “Load Modes Introduction” for details). The load mode adjustment method is as follows.

### “Manual Mode” Operation

Only when the load mode is the “Manual Mode” of code (15), the manual operation to turn on or off the load is valid.

**Operation Method: Short press** the “RETURN” key in any main interface to turn on or off the load.

### Load Modes Introduction

Code	Definition	Description
0	Daylight Auto-Control	DC load turns on when no daylight is detected.
1~14	Daylight On/ Timer Off	DC load turns on when no daylight is detected. DC load turns off according to timer. 1-14 indicates Timer setting hours.
15	Manual Mode	DC load can be turned on/off by pressing the “RETURN” button.
16	Testing Mode	DC load turns on and off in a quick succession.
17	Always On	DC load will be on for 24 hours a day.

 **Note:** For load modes 1-14, the number means the load lasting time, e.g., “1” means the load would turn off in 1 hour after turning on, and “8” means off in 8 hours. Please notice that the detection of sunlight would turn off the load for all load modes 1-14, even if the timer hasn’t run out yet.

# LED INDICATORS

 **PV Indicator:** Indicating the controller's current charging mode.

Status	Description
Off	No Solar Input *PV LED is generally off during nighttime.
Double Flash	Solar Input Detected
Single Flash	Reverse Polarities Detected
Steady On	Solar Input Steady
Slow Flash	In Equalize/Boost/Float Charge

 **BAT Indicator:** Indicating the battery's current state.

Status	Description
Single Flash	Reverse Polarities Detected
Fast Flash	Battery Over Voltage
Slow Flash	Battery Over Discharged
Steady On	Battery On

 **LOAD Indicator:** Indicating the loads' on / off and state.

Status	Description
Off	Load Off
Fast Flash	DC Load Short Circuit / Overloading
Steady On	DC Load On

 **Fault Indicator:** Indicating whether the controller is functioning normally.

Status	Description
Off	No Errors
Steady On	System Error Detected

# BLUETOOTH INSTALLATION AND OPERATION

---

The MPPT controller is equipped with a built-in Bluetooth module that can be monitored and controlled via the app available on the Apple App Store and Google Play.



Bluetooth APP Installation & Operation

## BLUETOOTH CONNECTION

- Step 1 Turn on your phone's Bluetooth.
- Step 2 Tap the Bluetooth icon on the upper right corner of the interface and connect Bluetooth with the device named "BT-PQCC2430" her.
- Step 3 Check the upper left icon on Device Information.
- Step 4 Check whether all parameters in "Real-Time Monitoring" are displayed.

## PARAMETER SETTINGS

Enter the "Parameter Settings" and unlock the settings. Set the battery type and system voltage based on the system and tap confirm to save the setting.

If you have any questions or need any help with parameter settings or information reading, please contact us at [service@ipowerqueen.com](mailto:service@ipowerqueen.com).

# SPECIFICATIONS

---

Parameter	Value
Model	PQ-MPPTCC2430
System Voltage	12V / 24V / Auto <sup>①</sup>
No-Load Loss	12mA at 12V/ 10mA at 24V
Battery Voltage	9V to 32V
Max. Solar Input Voltage	100V
Max. Power Point Voltage Range	Battery Voltage+3V to 76V
Rated Charging Current	30A
Rated Load Current	20A
Max. Capacitive Load Capacity	8000uF

① Selecting LI (LiFePO4) battery type requires locking the battery system voltage and cannot be selected for “AUTO” mode (automatic recognition of system voltage).

Parameter	Value
Max. Solar Panel System Input Power	450W for 12V / 900W for 24V
Conversion Efficiency	≤97%
MPPT Tracking Efficiency	99,9%
Temperature Compensation Factor	-3mv/°F or °C/2V (Default)
Operating Temperature	-31°Fto 113°F / -35°C to 45°C
Protection Degree	IP32
Weight	4.41lb / 2kg
Communication Method	RS485(RJ12) / Inbuilt BT
Altitude	≤ 3000m
Dimensions	L9.65*W7.07*H3.25 inch / L245*W180*H82.5 mm

# BATTERY TYPES AND RELATING

Setting		
	FLD	SEL
Equalize Charge Voltage	14.8 V	14.6 V
Boost Charge Voltage	14.6 V	14.4 V
Float Charge Voltage	13.8V	13.8V
Boost Charge Recovery Voltage /Equalize Charge Voltage Days	13.2V	13.2V
Over Discharge Recovery Voltage	12.6V	12.6V
Over Discharge Voltage	11.1V	11.1V

The above are the specific parameters of 12V system voltage for different battery types. If the system voltage is 24V, the specific voltage parameters are the above parameters multiplied by 2, and the “Equalize Charge Voltage Days” should remain unchanged.

# PARAMETERS

Batterietyp		
GEL	Li (Default)	USE (User-Definable)
---	---	---
14.2 V	Default: 14.2V	Default: 14.2 V
13.8V	---	Default: 13.8V
13.2V	---	Default: --Tage
12.6V	Default: 11.1V	Default: 12.6V
11.1V	---	Default: 11.1V

# TROUBLESHOOTING

---

Error Code	Error	Solution
E00	No Error	System Functioning
E01	Battery Over-discharged	The battery voltage is too low. DC load will be turned off until the battery re-charges to recovery voltage.
E02	Battery Over-voltage	The battery voltage has exceeded the controller limit. Check battery bank voltage for compatibility with the controller.
E04	Load Short Circuit	DC load short circuit. Disconnect the load and check if the rated current of the load is less than 20A.
E05	Load Overloading	DC load power draw exceeds controller capability. Reduce load size or upgrade to a controller with higher DC load capacity.
E06	Overheating	The controller exceeds the operating temperature limit. Ensure the controller is placed in a well-ventilated, cool, dry place.



Error Code	Error	Solution
E07	Environmental Over-temperature	The environment temperature detected by the external temperature probe is too high.
E10	Solar Over-voltage	Solar array voltage exceeds controller-rated input voltage. Decrease the voltage of solar panels connected to the controller.
E13	Solar Reverse Polarity	Solar array input wires connected with reverse polarities. Disconnect and re-connect in the correct polarities.
E14	Battery Reverse Polarity	Battery wires connected with reverse polarities. Disconnect and re-connect in correct polarities.

If the problem cannot be resolved or you need any help, please contact us at [service@ipowerqueen.com](mailto:service@ipowerqueen.com).

# SYSTEM MAINTENANCE

---

To always keep the controller's performance at its optimum level, it is recommended to check the following items twice a year.

1. Make sure the airflow around the controller is not blocked and clear away any dirt or debris on the radiator.
2. Check if any exposed wire gets its insulation undermined due to exposure to sunlight, friction with other surrounding objects, dry rot, damage by insects or rodents, etc. Repair or replace those affected when necessary.
3. Verify that the indicator lights are consistent with the operation of the device. Please note that if any faults or errors are displayed, corrective measures should be taken if necessary.
4. Check all wiring terminals for any sign of corrosion, insulation damage, overheating, or burning/discoloration, and tighten all the terminal screws.
5. Check if there is any dirt, nesting insects, or corrosion, and clean as required.
6. If the arrester has failed, replace it with a new one time to prevent the controller and even other devices owned by the user from being damaged by lightning.

**⚠ Warning:** Risk of Electric Shock! Before carrying out the above checking or operations, always make sure all power supplies of the controller have been cut off!





**POWER QUEEN**<sup>®</sup>

Shenzhen Lizu Time Technology Co., Ltd

 [service@ipowerqueen.com](mailto:service@ipowerqueen.com)

 [technicalsupport@ipowerqueen.com](mailto:technicalsupport@ipowerqueen.com)