

TANACOM 500

OPERATING MANUAL

Thank you for purchasing a TANACOM 500. To take full advantage of the reels many useful functions, please read this manual carefully before using. Retain this manual for future reference.

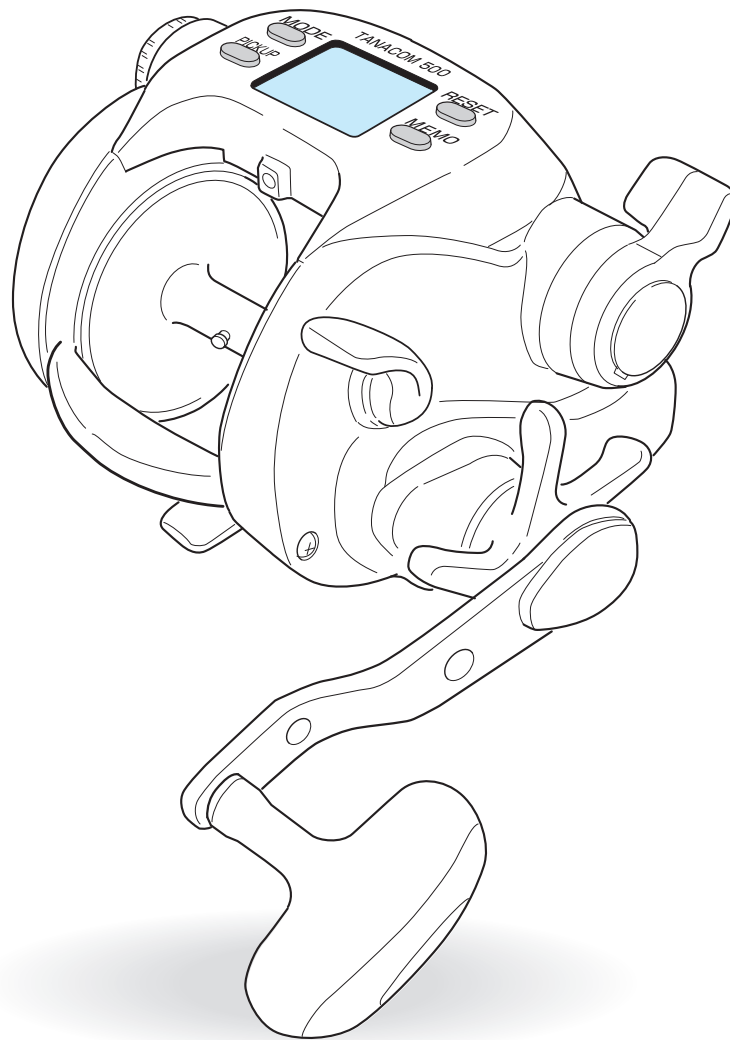

Reference







Index

Caution	1		
Precautions	1		
Power source	2		
How to connect the reel to the power source	2		
About the power source	2		
Battery indicator	2		
Using the Reel	3		
About the counter display	3		
Maintenance	4,5		
About maintenance	4		
Maintenance procedure	4		
Handling and maintenance of the power cord	5		
Maintenance of the power cord	5		
Other maintenance points	5		
Names of the buttons and the display	6,7		
Names and functions of each part	8,9		
Line data input	10-15		
Designated input------(P1)	10,11		
When line length is known------(P2)	12,13		
With Backing line------(P3)	14,15		
Functional setting operation	16-30		
1 Mode setting display	16,17		
How to set the many functions available	16,17		
2. Before you begin fishing	18		
Surface depth setting	18		
When the main line is cut or broken off.....	18		
3. Auto stop function	19		
Auto stop setting	19		
Auto stop	19		
4. Line feeding function	20		
Line feeding function	20		
5. Pickup speed setting	21		
Pickup speed preference	21		
6. Inverse counter	22		
Inverse counter	22		
7. Drift mode	23,24		
How to use Drift mode	23		
Drift	23		
Drift /Bite alarm	23		
Sensitivity adjustment for Drift/Bite alarm	24		
Drift /Click	24		
Fishable layer memory	24		
8. Jigging	25-27		
Jigging	25		
Jigging master	26,27		
9. Chumming timer	28,29		
Chumming timer	28		
Chumming timer winding	28,29		
10. Display recalibration	30		
Display revision	30		
Useful functions	31		
Various alarms	31		
Display light	31		
Breaker display	31		
Reel Specifications	32		
Reel Specification list	32		
Counter display	32		
Parts List	33		
Trouble shooting	34		

Caution

Precautions

Warning		1. Be careful to keep fingers clear of the levelwind mechanism. It can pinch your fingers and cause injuries.
		1. If your sinker or lure is caught on the bottom, cut your line rather than jerk the rod to free it. 2. After fishing, rinse and dry the reel thoroughly. Store in a dry place. 3. Handle the reel with care. Dropping it may cause damage. 4. Do not touch the line while reel is running. It could cut your skin. 5. Use this reel for fishing purposes only. 6. Be careful not to get reel grease on your clothing. 7. Do not use metal wire for the main line. 8. Sharp impacts due to inadvertent drop or other reasons may cause reel body breakage, damage to the inner electronic components, and cracks or short circuit of the board, resulting in functional disability.
Attention		1. When you use a power source other than the battery or the power source provided by the boat, be sure it is of the proper voltage. Excess voltage will harm the reel and may generate enough heat to burn your hands. 2. Do not use badly rusted cord to prevent electrical heat.
		1. Do not touch moving parts while the reel is operating or it may cause injury. 2. Drag adjustment should only be done with the auto winding functions off.
		1. Do not disassemble the reel. It could result in malfunction that could damage the reel or cause personal injury.

About the counter display

The following conditions may make the display difficult to read.

1. Wearing of polarized glasses.
2. Excessively cold or hot weather, mid-winter (display's surface temperature is below -10 degrees centigrade) and mid-summer (display's surface temperature is above 60 degrees centigrade).
3. When light strikes the display from certain angles, the display's digits may have shadows. This does not affect its function.

Do not reel in the end of the line

DO NOT allow end of line to be wound onto the spool. This may cause synchronization with the levelwind to be lost, a condition that can damage the levelwind due to the reel's high power output. Should this happen, line should be removed from spool and rewind.

After each trip, attach line to line clip to prevent it accidentally being wound onto reel.

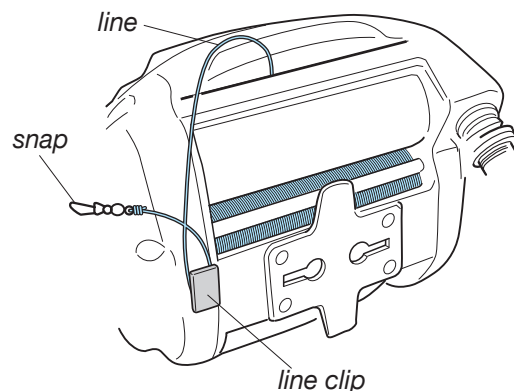
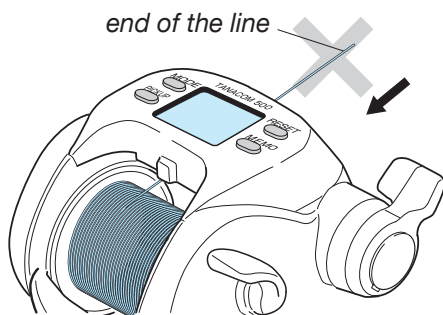

Power source

How to connect the reel to the power source

1. Attach the cord clips to the battery. Red covered clip is the plus (+), and the black covered clip is the minus (-).
2. Insert the connector into the reel. After this, the display appears as below. By taking the appropriate steps, the indication will change as shown below and the data will be set.

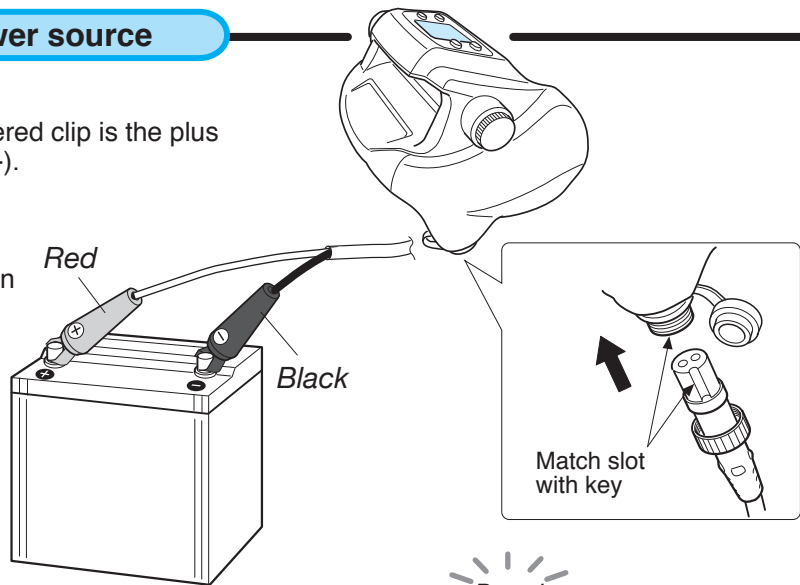

All the features light

0.5 sec



An indication change

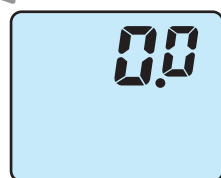

Set completion



Attention

1. When changing batteries, the display's back up memory stays active for about 15 minutes after the old battery is disconnected. Thus the above display startup sequence does not need to replay when the new battery is connected within the 15 minute time frame.

About the power source

This reel is made to accept DC 12 Volt power only. Power sources providing other than this cannot be used. The power provided by a boat can be unstable, causing the reel to stop unintentionally. To make the most of the reels performance, be sure to use the specified battery for the electric reel.

240V

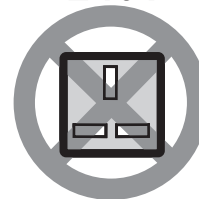

24V

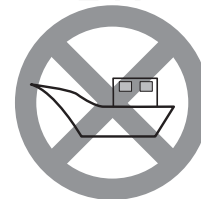

Attention

Make sure of the following before departure.

1. Recharge the battery before your fishing trip. Over time, a battery can naturally discharge.
2. Confirm the boat can provide the proper power source (i.e. voltage, connector shape etc).
3. Corroded connections can prevent the flow of electric current. Remove any corrosion or dirt from the connectors.

Battery indicator

With power on, digits of the inverse counter (counter in the lower area) will blink if voltage gets below DC 9 V. If the display shows this when the motor is not running, then battery voltage is likely to be low. In this case, replace the battery with a recharged one.

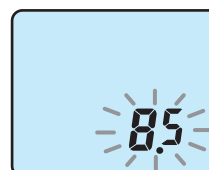

This figure shows the voltage is 8.5 V

Using the Reel

1. Do not jerk your rod to free a lure or sinker stuck on the bottom. Pull the line taught with a gloved hand and cut it.
2. After maintenance, be sure to loosen the drag and store the reel in a dry place.
3. Handle the reel with care to avoid dropping and possibly damaging it.
4. Do not use metal wire as the reel's main line.

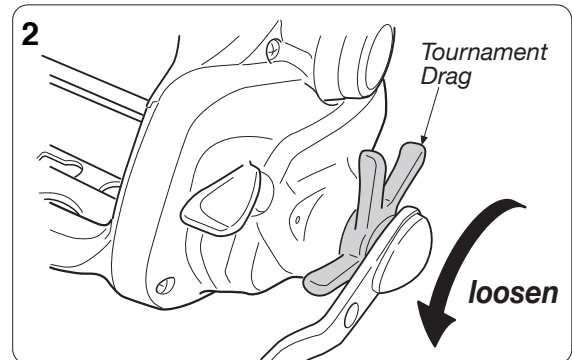
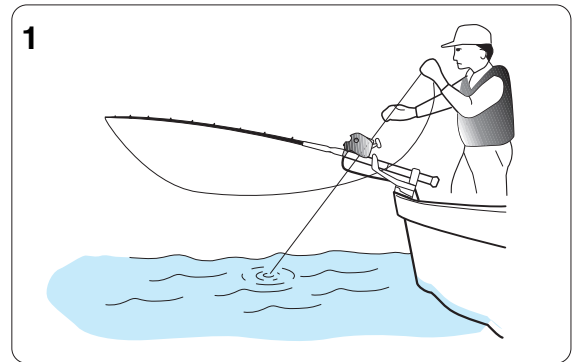

About the counter display

The following conditions may make the display difficult to read.

1. Wearing polarized glasses.
2. Excessively cold or hot weather, mid-winter (display's surface temperature is below -10 degrees centigrade) and mid-summer (display's surface temperature is above 60 degrees centigrade).
3. When light strikes the display from certain angles, the display's digits may have shadows. This does not affect its function.

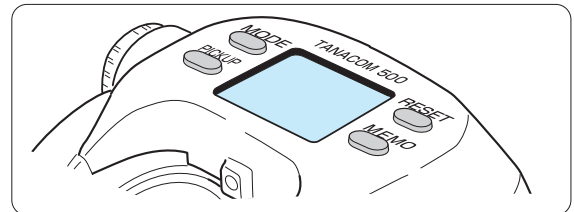

Maintenance

About maintenance

This is a washable reel. Wash away salt residue and grit after fishing.

Maintenance procedure

1. Wash the reel with a dish washing detergent and a soft sponge. Do not use solvents.

Do not use soap or other detergents. Other soaps or solutions may damage the reel both externally and internally. The solution may damage the outside coating of the reel and may breakdown the grease inside of the reel creating an overflow of grease.

2. Rinse detergent and dirt away with running water, rinsing the spool very well to get rid of salt. Use warm water, under 30 degrees centigrade.

3. Dry the reel well.

*Loosen the drag when stored.

*Be sure to remove water from inside the handle knob, because water could build up there.

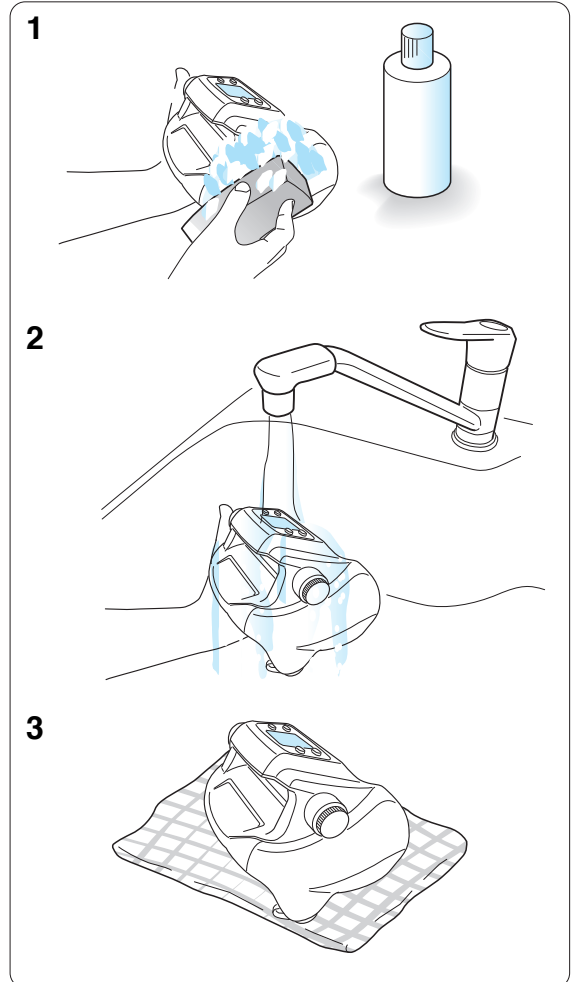

1. Do not wash with seawater or soak in water.
2. Do not use organic solvents such as benzene and thinner.
3. Do not use a steel brush or abrasive cleanser.
4. Never lubricate the drain opening.

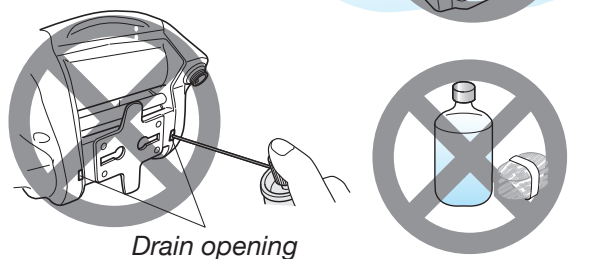

Maintenance

Handling and maintenance of the power cord

Follow the restrictions below to avoid cord problems. Do not cut or connect your cord by yourself as it can cause unintended problems.

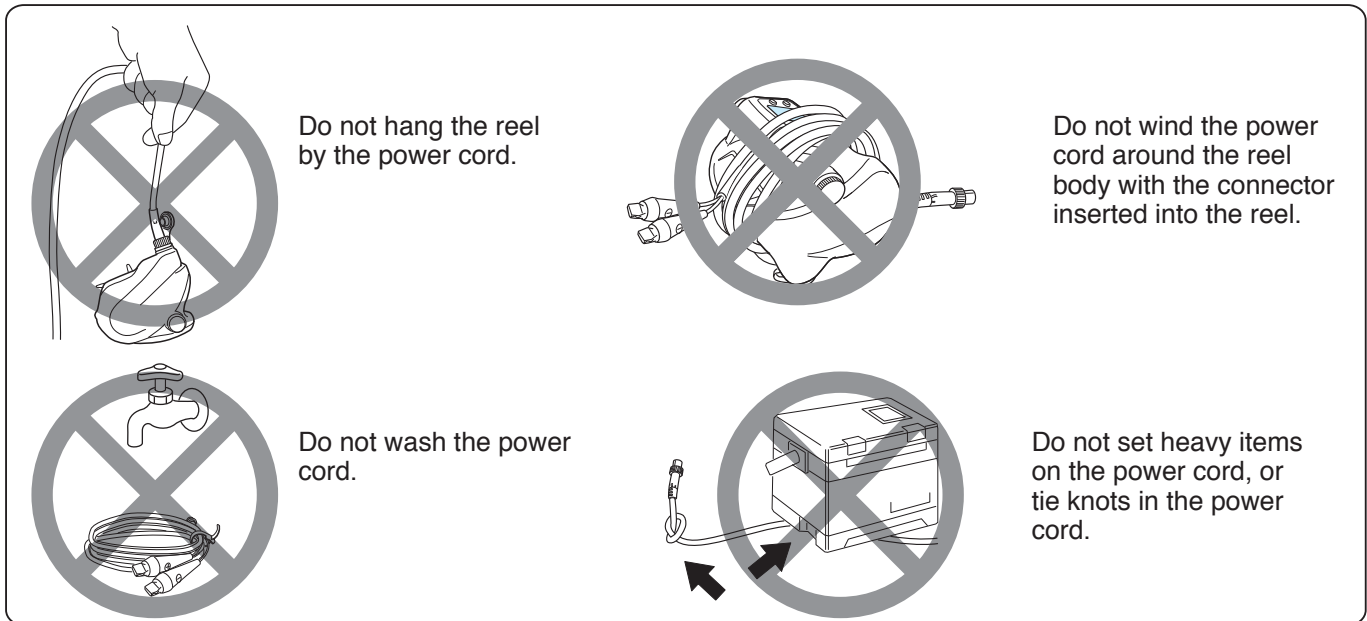

Maintenance of the power cord

- Wipe the power cord with a wet cloth and dry it well.
- Pay special attention to drying the tips, with cover removed.
- Grease the connector after it is dried.
- Disconnect the power cord from the reel before storing.

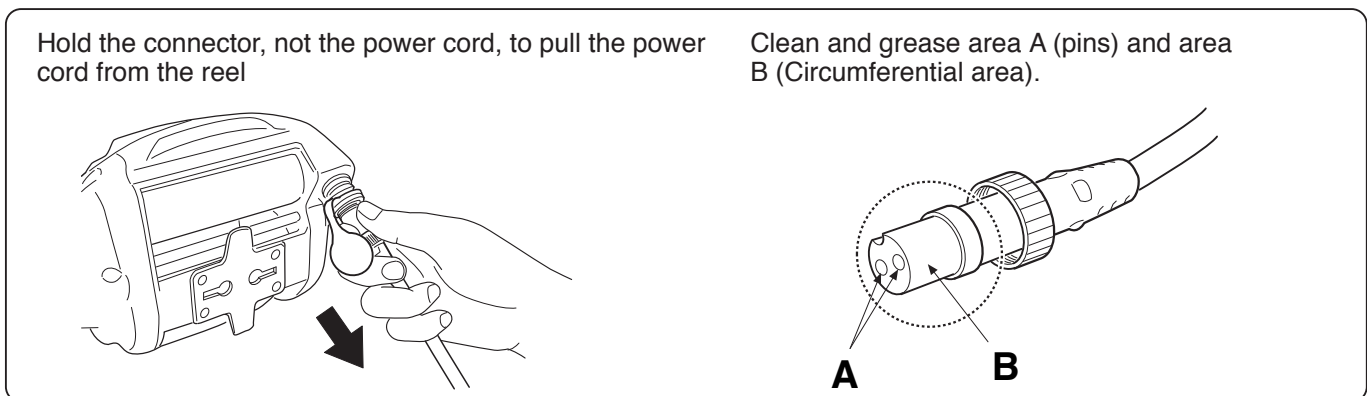

Other maintenance points

- This reel is a precision instrument that employs electric circuitry and motor. Do not disassemble the reel by yourself.
- Cover the power connector on the reel with its protection cap.
- Old or worn cords can cause a bad connection and/or short circuit. Replace the cord every 2 years.

Names of the buttons and the display

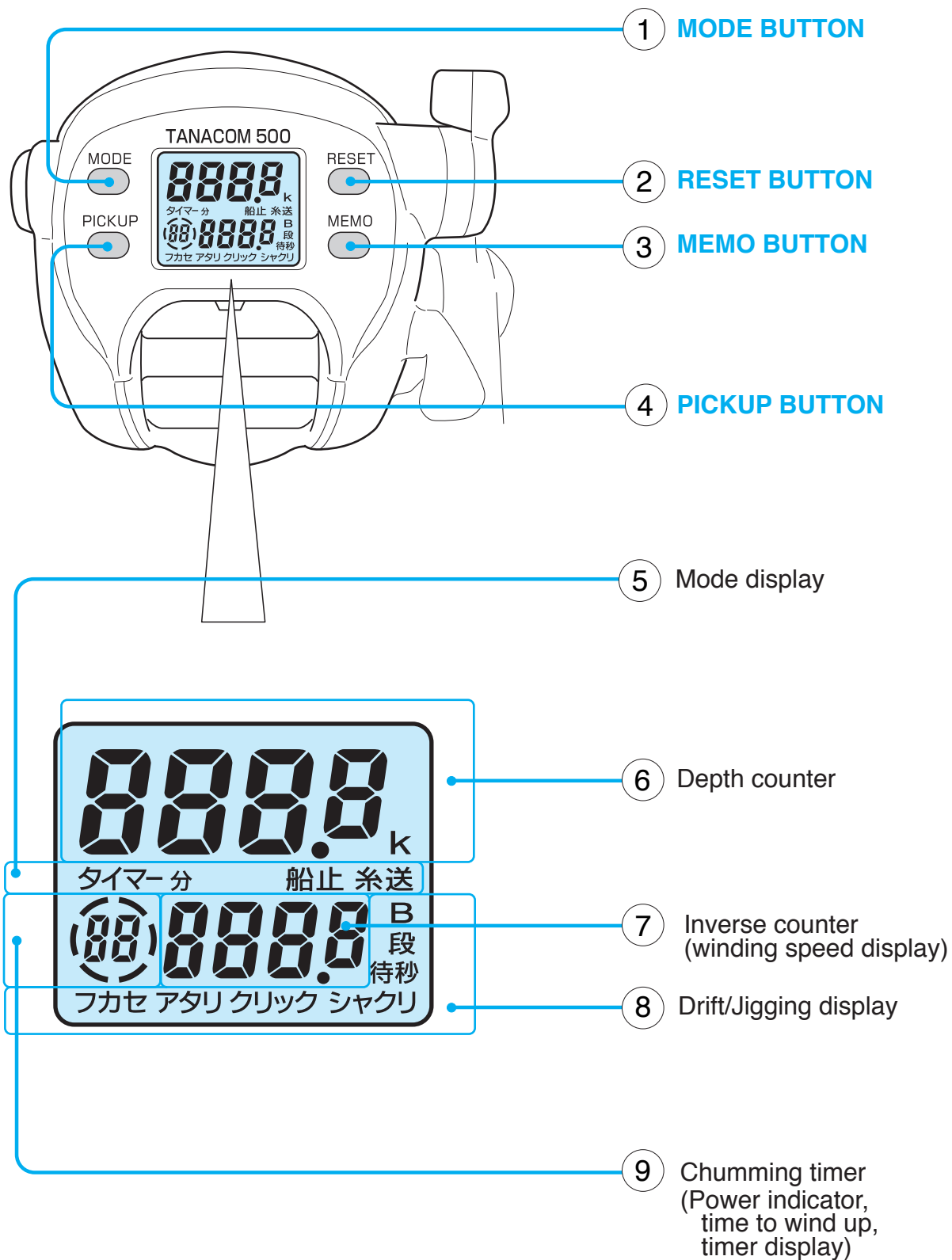

Names of the buttons and the display

① MODE BUTTON

Press the **MODE BUTTON** to scroll through the adjustment displays for each reel function.

- Use the Power Lever to adjust numeric values.
- Pressing the **MODE BUTTON** sets the numeric values you have adjusted.
- Depress and hold the **MODE BUTTON** to return to the depth display.
- Mode change cannot be done while line is being fed.

② RESET BUTTON

This button resets the depth counter to zero.

Make sure to press this button before you start fishing. The reset depth is used to make the auto stop function work. (display shows ). The default setting of auto stop is 2 meters.

This prevents accidental resetting. For a total reset, when line has been broken off, press and hold the button for at least 2 seconds.

③ MEMO BUTTON

Pressing this button resets the counter in the lower area of the display.

- It memorizes distance from the bottom, handy for dropping a bait right back into the strike zone after you've been bit.
- The chumming timer resumes after pressing this button.

④ PICKUP BUTTON

Selection between pickup and jigging can be done in the mode setting display. (One of them should necessarily be chosen.)

Pickup



- You can wind only while pressing this button. This function is useful to wind up line slack and attract fish.
- Winding speed can be changed with the mode setting display. (Default setting is speed 15)

Jigging

- Jigging can be ON/OFF.
- Pressing this button starts jigging. (Display shows )
- Pressing the button again stops jigging.

⑤ Mode display

- This display allows you to change setting of each function.
- The functions that are set to work are shown on the display. (Default setting is speed 15, but the speed can actually be set between 0~Hi.)

Display	Function
	Chumming timer starts working.
	Auto Line feeding is employed. Default setting is off.
	Pressing the RESET BUTTON makes this indicator appear, telling you auto stop will work.

⑥ Depth counter

- It shows the depth from the surface.

⑦ Inverse counter (winding speed display)

- This counter shows the depth from the bottom (or a certain depth).
- Once this counter is turned on, its display cannot be turned off.
- While winding up, winding speed appears in meters per minute. (The display of winding speed can be set to OFF)

⑧ Drift/Jigging display

- This is appeared only when the jigging function is on.
- It blinks when jigging is in process.

⑨ Chumming timer (Power indicator, time to wind up, timer display)

- The chumming timer appears when motor rotation is stopped. The timer display cannot be set to OFF.
- While using the power lever, the power level is shown.
- While the electric winding up is in action displaying actual winding speed, the timer indicates the remaining time to auto stop at the ship side (in minutes and seconds).

Names and functions of each part

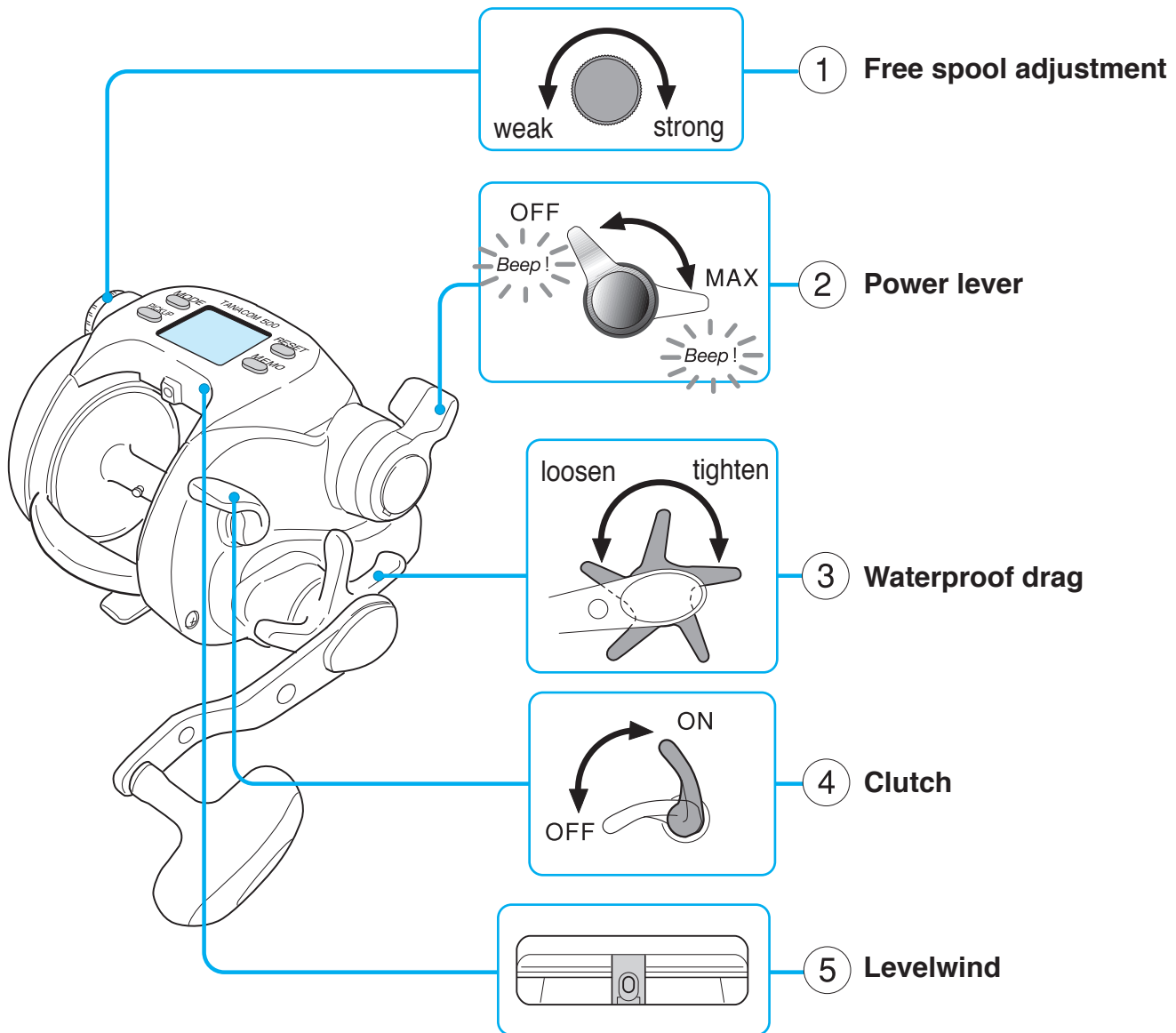

6 Enclosed items

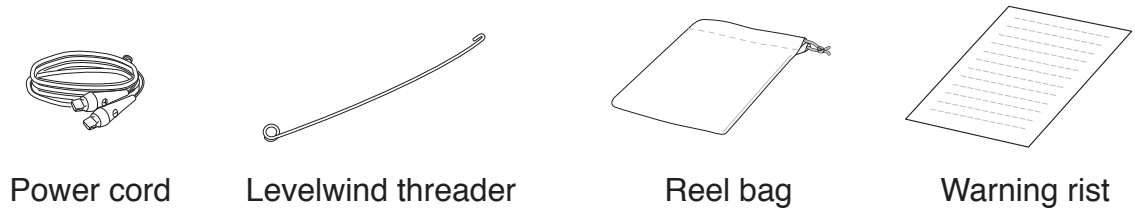

Power cord

Levelwind threader

Reel bag

Warning rick

Names and functions of each part

1 Free spool adjustment

- It adjusts brake tension on the spool to prevent backlash or line slack caused by dropping the line with hook and sinker.

2 Power lever

- You can freely adjust winding power, or winding speed, from zero(ON/OFF) to maximum, by 32 steps, by using the lever.
- Tilting the lever forward adds power and speeds up the winding.
- Pulling the lever back slows down the winding.
- Without the lever positioned to OFF, it is impossible to start winding. You have to pull it back to the OFF position before you start winding. An audible sound indicates the OFF position.
- The power lever is used to set numerical values on the various function displays.

3 Waterproof drag

- Adjusting the star drag allows the spool to slip against a strong pull to avoid line breakage.
- (1) Adjust the drag while reel is on the rod and the line is strung through all the line guides.
 - (2) Adjust drag with the clutch ON, while pulling the line with your hands. Normally, the drag is adjusted to prevent the weakest line in the line system from breaking.

4 Clutch

- Turning the handle automatically engages the clutch.
- ON position > line winding can be done.
- OFF position > spool is free-turning to let out line.

5 Levelwind

- The levelwind distributes line evenly on the spool as you wind it in.
(Under some special circumstances line may not wind evenly because of the clearance between the levelwind and the line.)

6 Enclosed items

- Power cord
- Levelwind threader (This tool simplifies threading line through the levelwind.)
- Reel bag
- Warning rist

Line data input (Designated input)

Designated input is a convenient procedure to input a line when you wind our TANA SENSOR BRIGHT. All you have to do is only inputting data. Note that this procedure is available only for the following cases.

- No under-winding is performed.
- The line number and wound line capacity are described in the list in Page 11.

1. Put the line through the levelwind, and tie it on the spool.

*Use the enclosed levelwind threader (see Page 8) for easy operation.

*Be sure to tie the line on the line stopper pin to prevent line slippage on the spool surface.

2. Return the power lever to the OFF position.

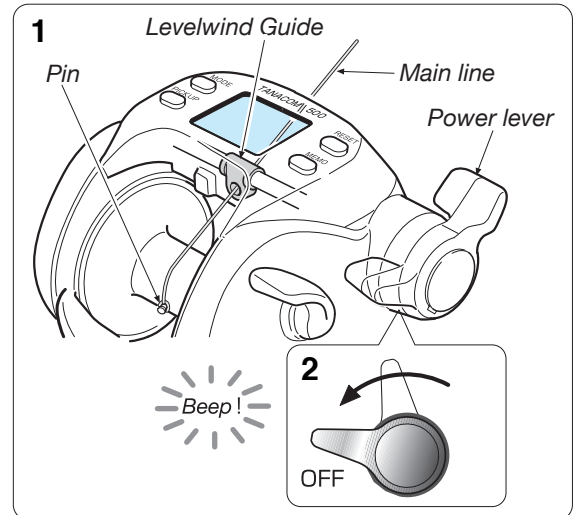

3. Supply power to the reel, get down the power lever to the MAX position, and wind up the line completely.

*For detail of the connection procedure, refer to “How to connect power source” in Page 2.

*Wind the line with the tension of approx. 1 kg.

*Be careful not to enwind the line.

*Be careful not to let the line contact with the fin guard. Otherwise, the reel may get damaged.

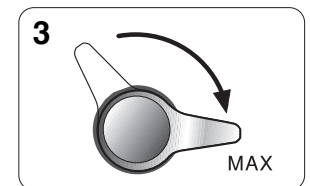

4. Keep pressing **MODE BUTTON** for 5 seconds while the display is “0.0”.

5. The screen for initial setting “PE 6 300” (PE No. 6, 300 m) appears.

6. Set a value with the power lever, and press **MODE BUTTON**. The procedure is completed. (The indication returns to “0.0”.)

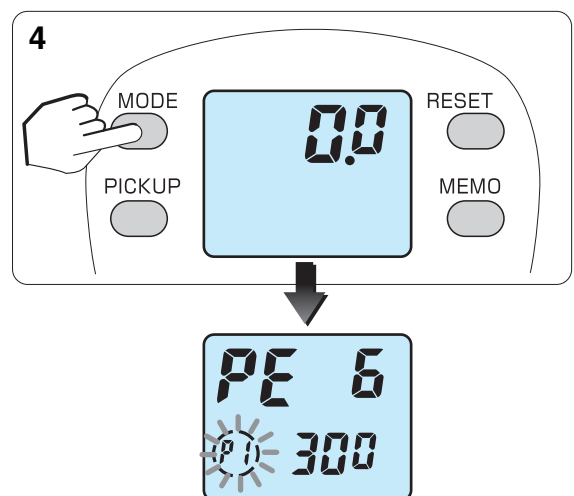

Line data input (Designated input)

PE (in case where PE is indicted in the upper left area) (m)						Fluorocarbon (in case where L is indicated in the upper left area) (m)					
No.4	100	200	300	400	470	No.5	100	200	300	400	420
No.5	100	200	300	350		No.6	100	200	300	330	
No.6	100	200	300			No.7	100	200	280	300	
No.8	100	200	220			No.8	100	200	240		
No.10	100	170				No.10	100	200			

*In TANACOM 500, the data of TANA SENSOR BRIGHT No.6-300 m is ready by default. When using that model, you don't have to input data.

Line data input (When line length is known)

This procedure is convenient if you have already known the length of a line you are going to reel. When you use a line other than our TANA SENSOR BRIGHT, operate this procedure.

1. Put the line through the levelwind, and tie it on the spool.

*Use the enclosed levelwind threader (see Page 8) for easy operation.

*Be sure to tie the line on the line stopper pin to prevent line slippage on the spool surface.

2. Return the power lever to the OFF position.

3. Keep pressing **MODE BUTTON** for 5 seconds while the display is "0.0".

4. The initial screen appears. ("P1" blinks.)

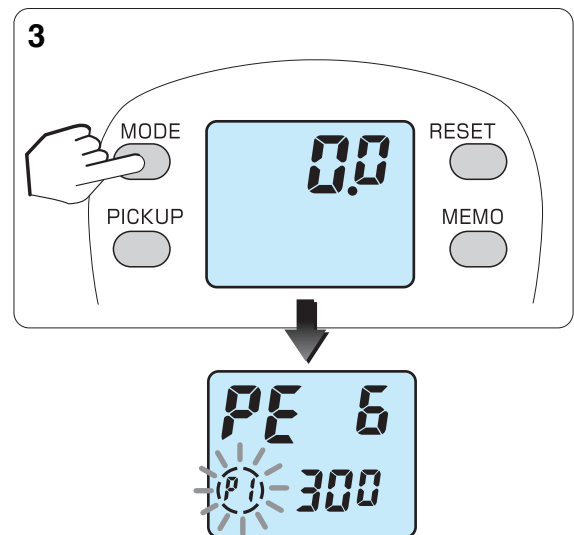

5. Press **MODE BUTTON** again.

("P2" blinks.)

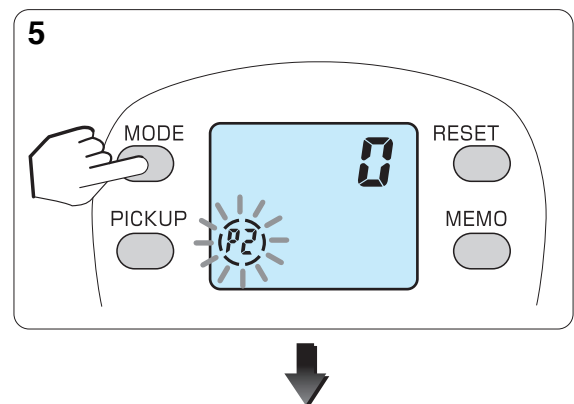

6. Get down the power lever to the MAX position, and wind up the line.

When the power lever is down, the screen switches to indicate tension.

Adjust tension so that the number indicated at the lower left of the panel is 4 to 5, and wind up the line.

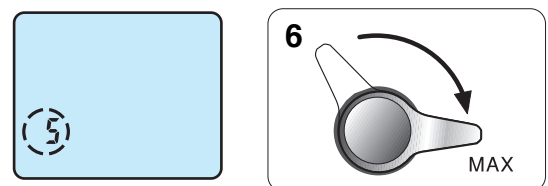

*Be careful not to let the line contact with the fin guard. Otherwise, the reel may get damaged.

Line data input (When line length is known)

7. When you finish winding, return the lever to the OFF position (the alarm sounds).

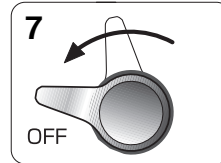

-Do not unwind the line completely. Return to the power lever to the OFF position just before the end, and wind the remaining line manually. Otherwise, the counter error may occur.

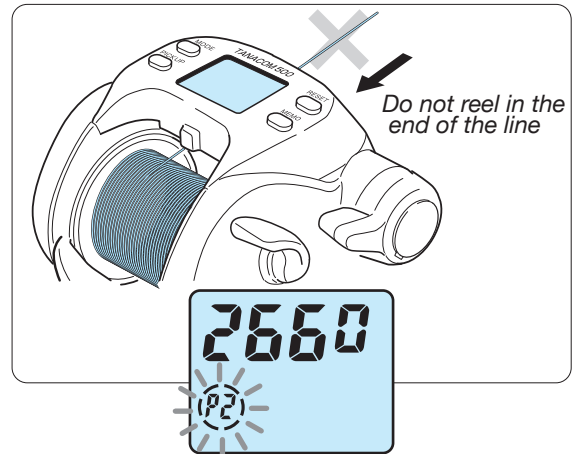

8. Keep pressing **RESET BUTTON** until the display indicates "300".

("300" is the initial value).

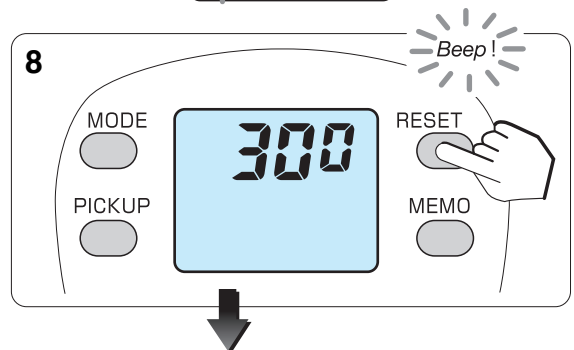

9. Set the line length with the power lever. (The figure shows a case where 280 m is input.)

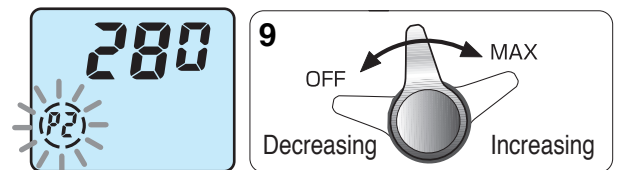

10. Keep pressing **RESET BUTTON** for at least 2 seconds. (When the alarm sounds and the display indicates "0.0", the procedure is completed.)

*When "Err" appears, input the data again. To return the indication to "0.0", press **MODE BUTTON**.

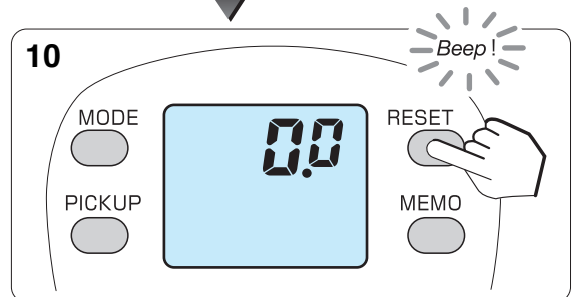

Line data input (With backing line)

Note that a 100 m or longer line of which length is known is necessary.

1. Supply power to the reel, get down the power lever to the MAX position, and wind up the backing line appropriately.

*For winding, be sure to use the line stopper pin to prevent line slippage on the spool surface.

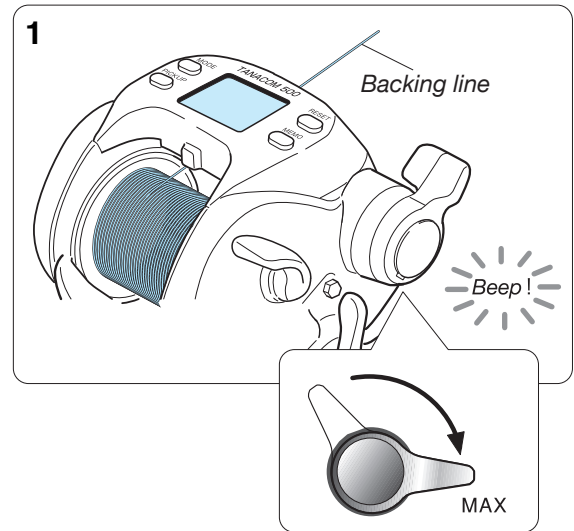

2. Tie the line and the under-wound line, and wind up the line. Check the line color, and stop winding when the remaining length of the line is 100 m.

*In case where the line capacity you prepared is 100 m, go to Step 3.

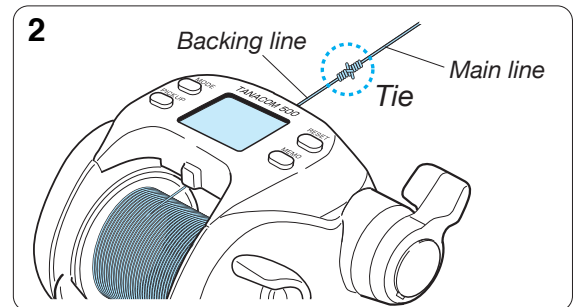

3. Keep pressing **MODE BUTTON** for at least 5 seconds.

(The designated input screen appears, and "P1" blinks.)

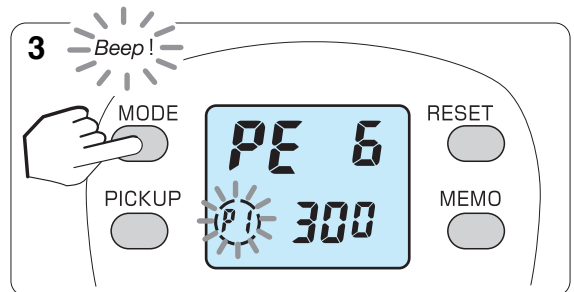

4. Then, press **MODE BUTTON** twice, and the backing line mode is ready.

("P3" blinks.)

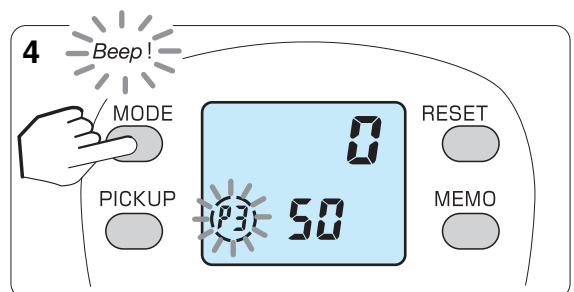

Adjust tension so that the number indicated at the lower left of the panel is 4 to 5, and wind up the line.

*Be careful not to let the line contact with the fin guard. Otherwise, the reel may get damaged.

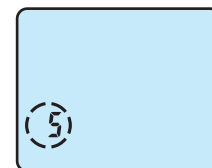

Line data input (With backing line)

5. As checking the line color, wind up the line by 50 m. Press **RESET BUTTON** for at least 2 seconds.

(The number indicated at the bottom changes from “50” to “100”.)

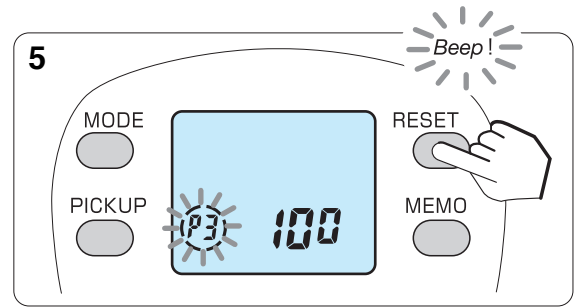

6. Similarly, wind up the remaining 50 m, and press **RESET BUTTON** for at least 2 seconds.

(The display indicates “0.0” and the procedure is completed.)

*When “Err” appears, input the data again. To return the indication to “0,0”, press **MODE BUTTON**.

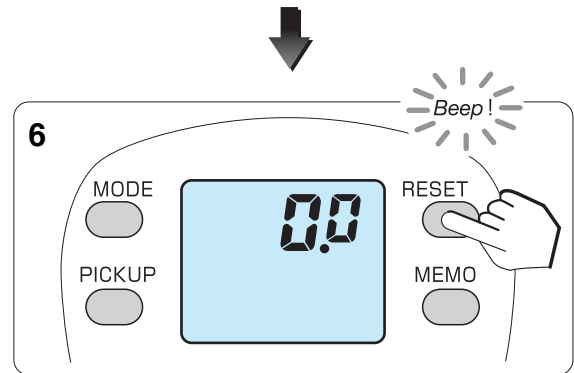

Functional setting operation (1. Mode setting display)

How to set the many functions available

- There are various convenient functions prepared in the mode.
- Operate the power lever on the setting screen, select ON or OFF of a value and function, and press **MODE BUTTON** to call the next screen. The setting procedure is completed.
- * The set function is memorized and effective in the next fishing.

1. Press **MODE BUTTON** and select a screen to be set.

Whenever you press **MODE BUTTON**, an indicated function to be set is switched.

*When you keep pressing **MODE BUTTON**, the screen switches at fast speed, and returns to depth indication display.

*Even if you change a setting value with the mode screen, the initial setting is restored whenever you press **RESET BUTTON**.

(Drift ON <-> OFF is excluded.)

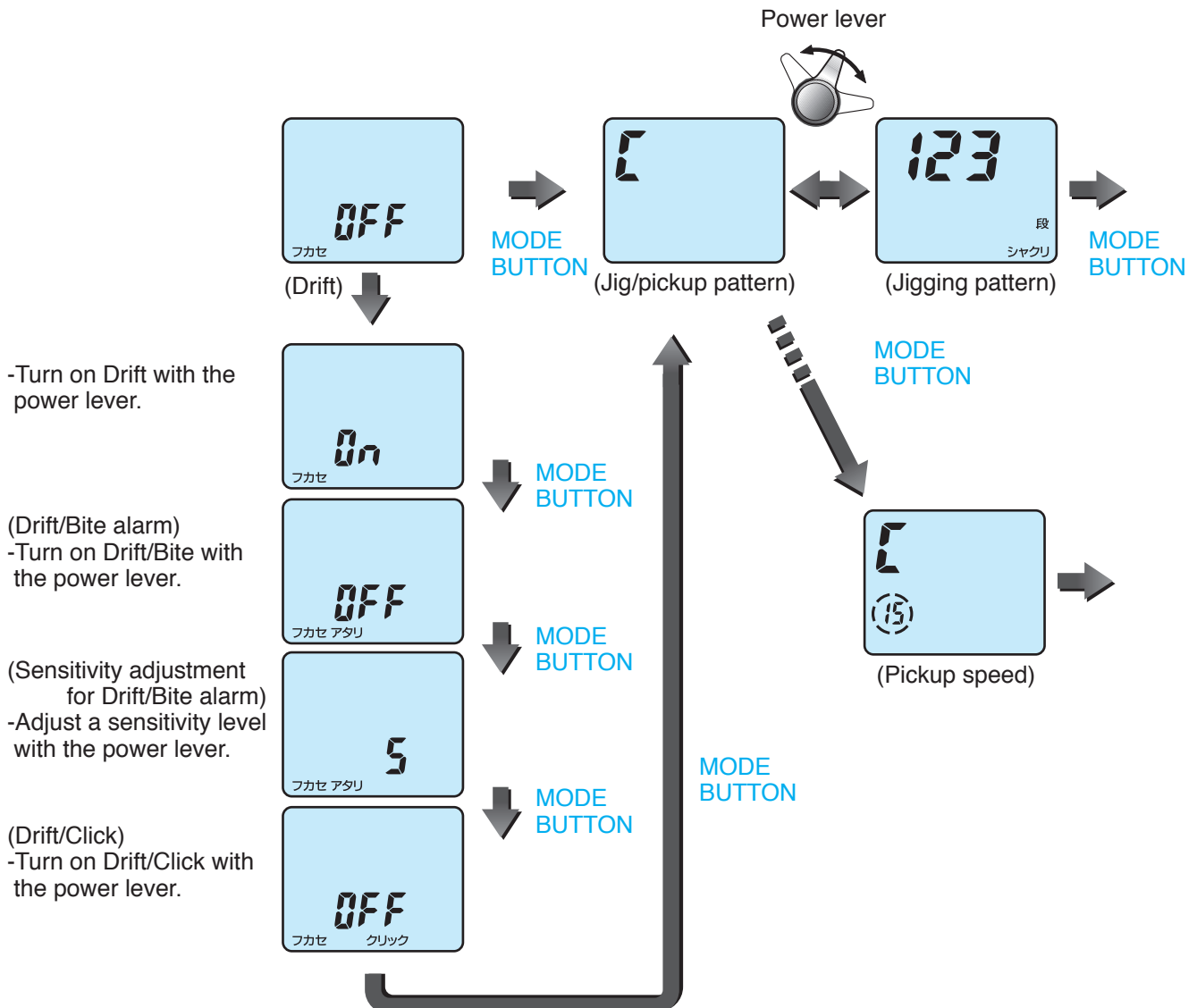
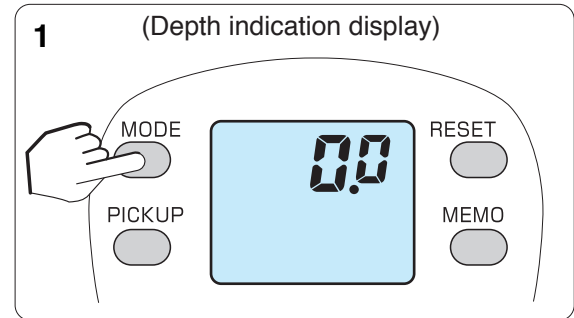

Functional setting operation (1. Mode setting display)

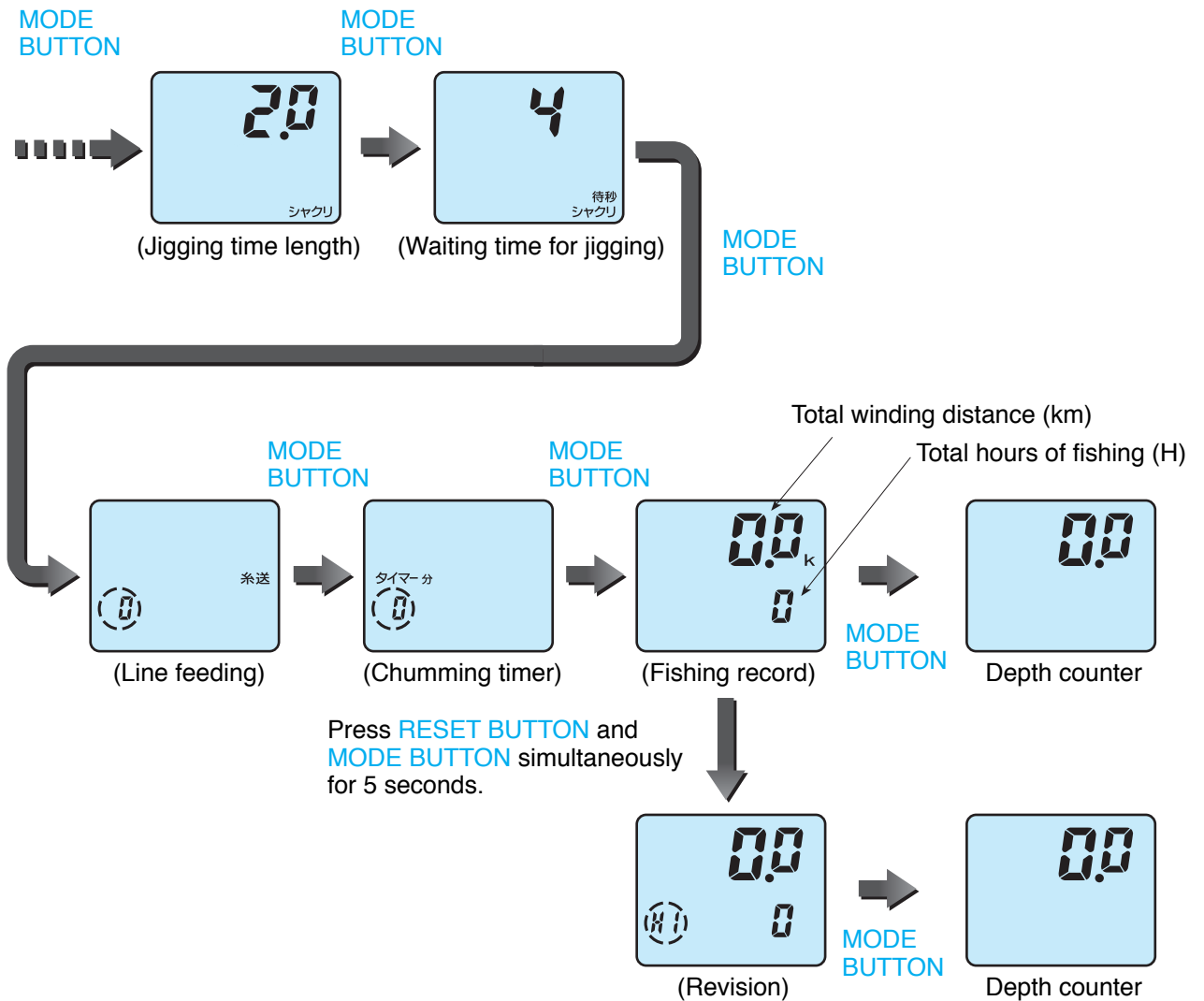

Functional setting operation (2. Before you begin fishing)

Surface depth setting

Before you begin fishing, make sure the counter is set to zero at the water's surface. This is extremely important to ensure accurate fishing depth readings.

1. Connect the reel to the battery, put the line through all the guides, and prepare your terminal rig.
2. Place the rod into the rod holder in the position it will normally rest while fishing.

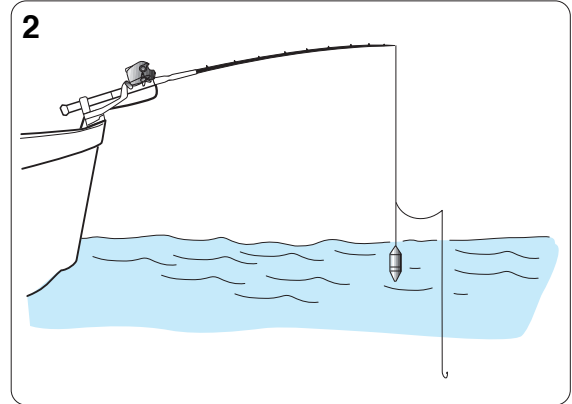

3. Lower the terminal rig to the water's surface and press the **RESET BUTTON**. (water surface zero setting)

The display resets to **0.0** and **船止** blinks.

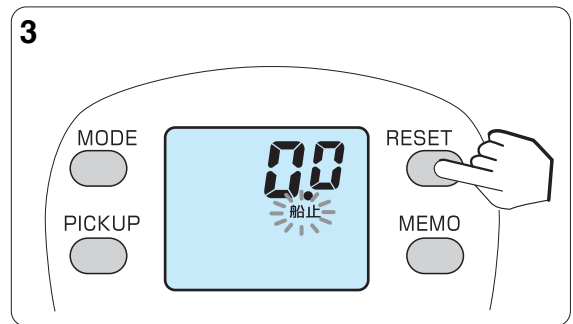

1. When new line is wound up, or when line has been pulled under heavy tension, line stretch may cause a gap in the depth reading at the surface. Simply reset the surface setting with the **RESET BUTTON**.

When the main line is cut or broken off.....

- Should your line break, revise data as follows.
- Wind the line to the rod tip, and press the **RESET BUTTON** for 3 seconds. (At depths greater than 10 m, 3-second-pressing is employed accidental pressing of the button.) If the display shows **0.0** then your re-adjustment is complete and data has been revised.
- Unless you reset the data on the reel, it will not be able to count accurately.

Functional setting operation (3. Auto stop function)

Auto stop setting

The Auto stop depth may be set to meet your own specific needs.

- Auto stop adjusts to operate at depths from 1 m to 5 m (in 10 cm increments).
- It prevents accidentally winding swivels, terminal rigs etc. into the rod tip and stops your rig at a consistent depth for convenient checking and changing of baits and sinkers.
- Line stretch can cause an inaccurate reading at the surface. Simply reset the counter to zero at the surface.

1. Connect the reel to the battery, and press the **RESET BUTTON** with your terminal rig at the surface.

The display shows **0.0**.

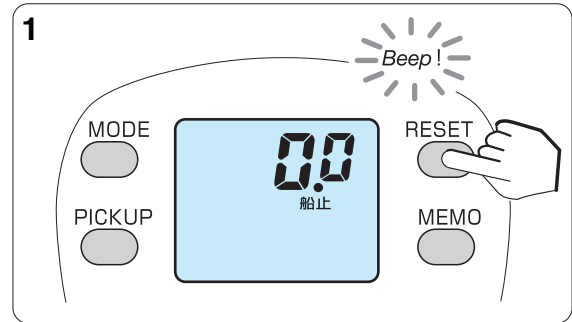

2. Raise the rod and adjust the line length from the rod tip so you can reach the rig easily. In the figure, its length is 1.5 m.



Checking and changing sinkers, baits etc.

Use

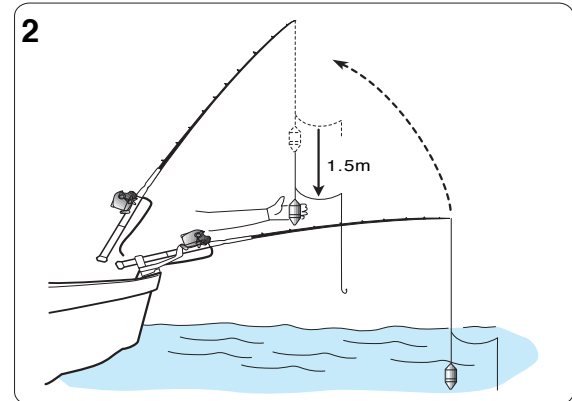

3. After adjusting length, press the **MEMO BUTTON** for 2 seconds.

When **1.8** blinks, this procedure is completed.
Default setting is 2.0 m. (Without pressing the **RESET BUTTON** the winding stops at a depth of 5.0 m.
The **船止** lamp will blink when the setup has been completed.

4. When checking or changing a bait, simply wait until the reel automatically stops winding and raise the rod tip.

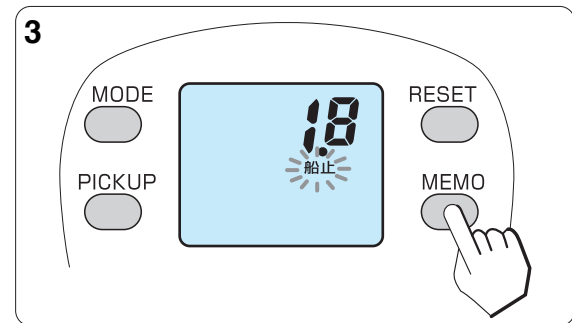

Auto stop

Auto stop automatically brings your terminal rig to the surface, and it stops at your pre-set depth. It eliminates the need to constantly monitor depth as it comes up.

- The auto stop function assists when winding with the power lever, jigging, or winding with the chumming timer.
- After the rig is ready, reset the depth counter to zero by pressing the **RESET BUTTON**. (water surface zero setting) (After this, **船止** appears on the display)
- Without pressing the **RESET BUTTON**, winding stops at a depth of 5 m.
- If you have pressed the **RESET BUTTON**, the alarm sounds at 2m increments above the depth of 8 m, and winding stops at 2 m.
- When auto stop depth is set, the alarm sounds every 2 m above the depth of 6 m, and winding stops at the set depth.
- After auto stop stops winding, the power lever can be used up to **0.0** m. However, above **0.0** m, motor winding such as, power lever and PICKUP, cannot be employed until the **RESET BUTTON** is pressed.
- Depending upon the rocking of the boat or sinker weight, auto stop depth can overrun slightly. Should this happen, increase the depth of the auto stop.

Functional setting operation (4. Line feeding function)

Line feeding function

The line feeding function lets our line with the motor assisting the spool.

- The line feeding mechanism begins to work at a depth of 2.5 m below the pre-set auto stop depth.
- If the clutch becomes ON while the reel is furnishing line, the spool begins to rotate to avoid line slack.
- Speed of the line going out is adjusted with 32 speed levels ranging between 0 and Hi. It is adjusted in the line feeding mode.

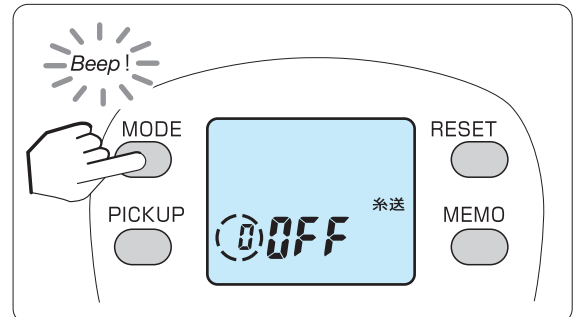

1. Press the **MODE BUTTON** to show the line feeding speed adjustment display. Default setting is zero (OFF). Set the speed level with the power lever.
2. Press the **MODE BUTTON** three times to show **0.0** (depth counter) to complete. The **糸送** will blink.

While the reel is feeding line with this function, its speed cannot be changed.

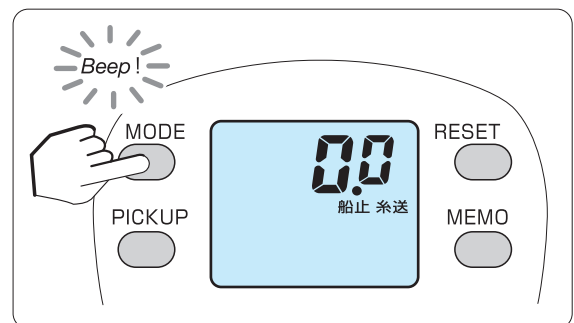
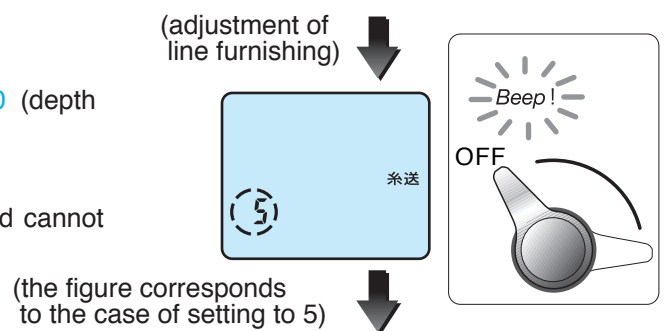

Functional setting operation (5. Pickup speed setting)

Pickup speed preference

1. Press **MODE BUTTON**.

If the display is at **シヤクリ** display, then move the power lever or press **RESET BUTTON** to show the display shown on the right.

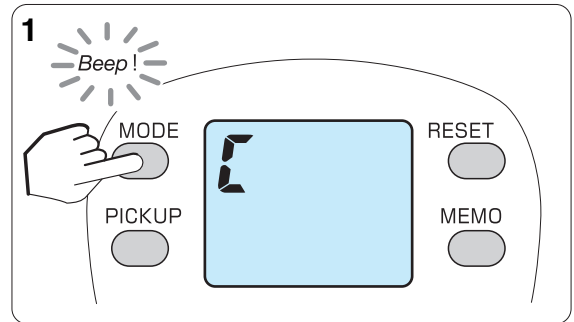

2. Press **MODE BUTTON** again.

This display is the pickup setting display.

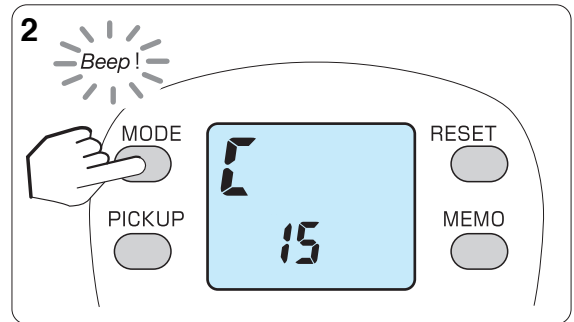

3. Set speed with the power lever.

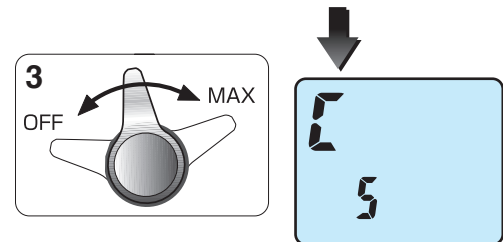

(the figure corresponds to the case of setting to 5)



While the power lever is at **MAX** position, pressing the **PICKUP BUTTON** makes the motor run at the pre-set pickup speed.

Use

4. Press the **MODE BUTTON** to go back to depth readout.

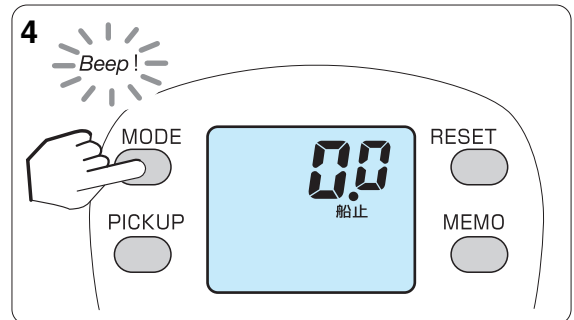

1. While the **PICKUP BUTTON** is in use for winding, winding speed is not displayed.

Attention

Functional setting operation (6. Inverse counter)

Inverse counter

Two counters are better than one. This reel has counters from both the surface and from the bottom.

The default inverse counter setting is OFF. To turn it ON, see page 16.
In the following example, intended fishing range is 94 m, which is 6 m from the bottom.

1. Clutch OFF to send the rig to the bottom

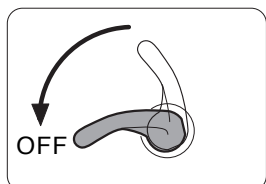

2. At the bottom, move the clutch to ON by turning the reel handle or flipping the clutch lever.

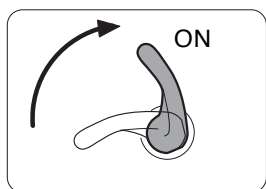

3. After winding up any slack line, press the **MEMO BUTTON** and wind up 6 m.

By pressing the **MEMO BUTTON**, the lower area counter is reset. Wind line until the intended depth is reached.



Use

By pressing the **MEMO BUTTON**, the timer starts and keeps an accurate record of fishing time.

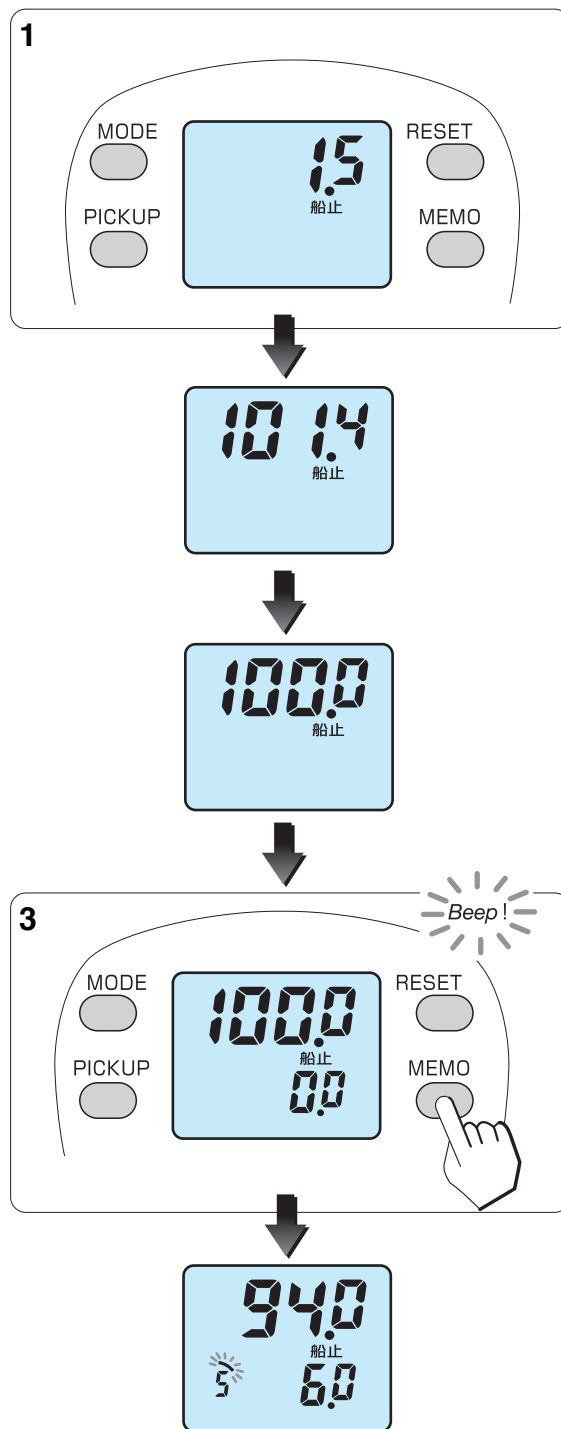

Functional setting operation (7. Drift mode)

How to use Drift mode

1. Turn on **MODE BUTTON** and display the **フカセ** screen.

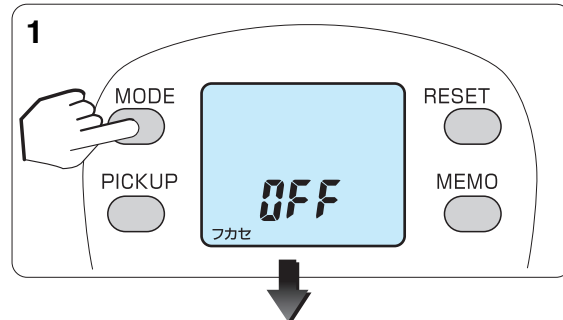

Drift

2. Turn on Drift by operating the power lever.

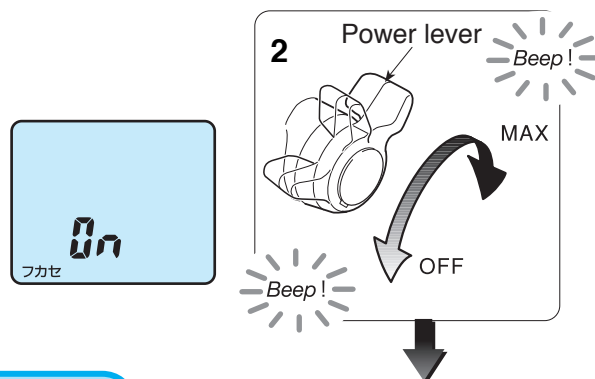

Drift/Bite alarm

When the reel detects movement faster than the set sensitivity level, the Bite alarm sounds to let you know a fish bites the hook. Therefore, you can recognize it even when you don't see the line.

3. Press **MODE BUTTON** to switch the current screen to the next one.
4. Turn on by operating the power lever.

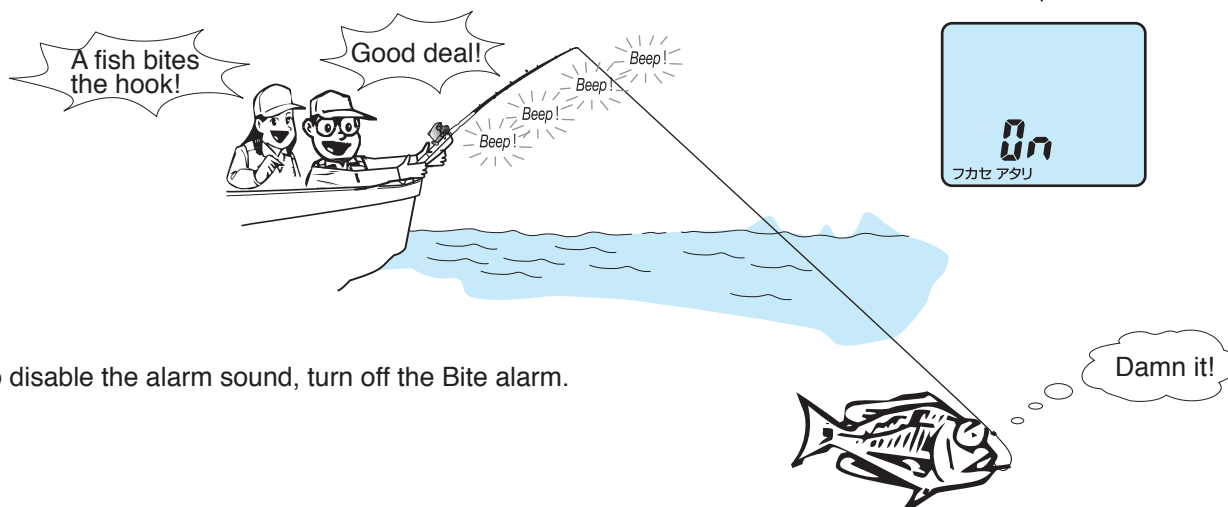
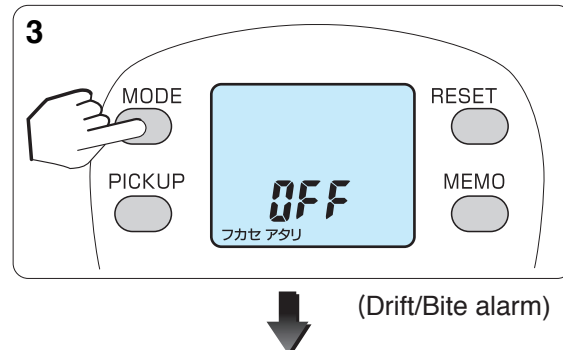

*To disable the alarm sound, turn off the Bite alarm.

Functional setting operation (7. Drift mode)

Sensitivity adjustment for Drift/Bite alarm

-In order to adapt to change caused by the current speed and wave size, you can adjust sensitivity of the Drift/Bite alarm.

5. Press **MODE BUTTON** to switch the current screen to the next one.

6. Turn ON by operating the power lever.

*You can adjust the level according to the current speed and wave size.

-The settable range is from 1 to 10.



(Sensitivity adjustment for Drift/Bite alarm)

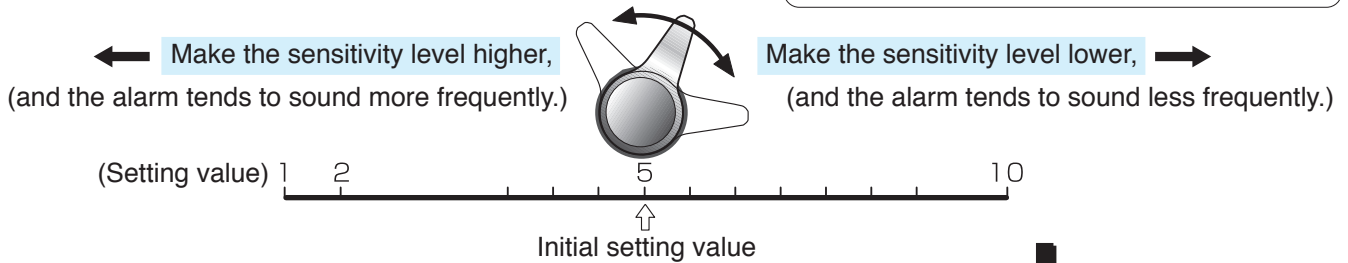
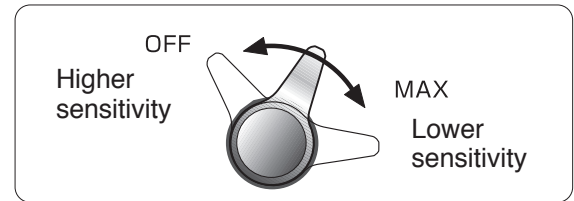

Drift/Click

-When Click is turned on, the alarm sounds every time when 1 m of the line goes out so that you can recognize the water flow (line feeding speed) by the sound.

-It starts from the water depth of 7 m.

7. Press **MODE BUTTON** to switch the current screen to the next one.

8. Turn ON by operating the power lever.



(Drift/Click)



Fishable layer memory

-A layer where the Bite alarm sounds is automatically memorized. Even if you make haste to operate the rod, you can confirm a fishable layer because the inverse counter blinks and indicates the layer where the Bite alarm sounded.

9. Press **MODE BUTTON** to switch the current screen to the next one.

* When you press **MEMO BUTTON**, the depth of the fishable layer memory is converted and indicated as "0.0".

* When a layer is located shallower than the memorized layer, the data is not updated until the reel stops a tackle at the boat side.



Blinking indication

<Example of fishable layer memory>
(The alarm sounds at the point 95.0 m deep, and the line is temporarily wound up by 5.0 m.)

Functional setting operation (8. Jigging)

Jigging

Jigging function is a convenient function.

After setting your preferences, pressing the **PICKUP BUTTON** starts the function.

Speed of the jigging can be adjusted with the power lever.

1. Press the **MODE BUTTON** to show pickup / jigging display.

(When jigging is chosen, the pickup function cannot be used.)

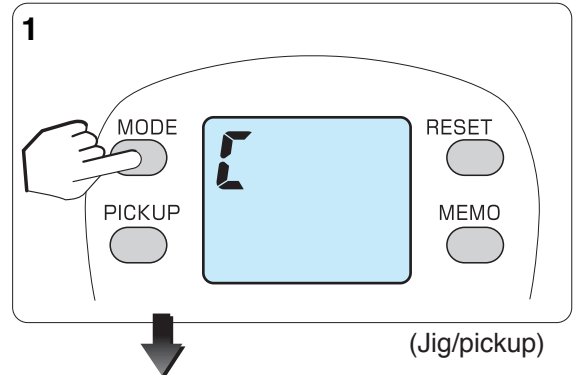

2. Jigging pattern is selected with the power lever.

There are four patterns; 123 (master), 1 step, 2 steps, 3 steps.

Jigging setting displays appear in the following order;
Pattern (step) > length (m) > waiting time (sec) > range (m)

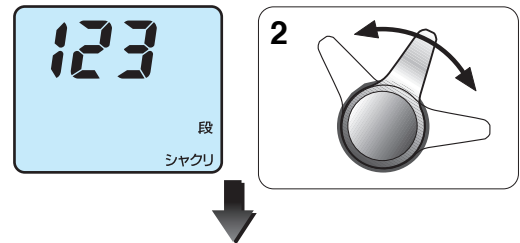

3. Press **MODE BUTTON** to show the next display. Pressing it also locks in the previous setting.

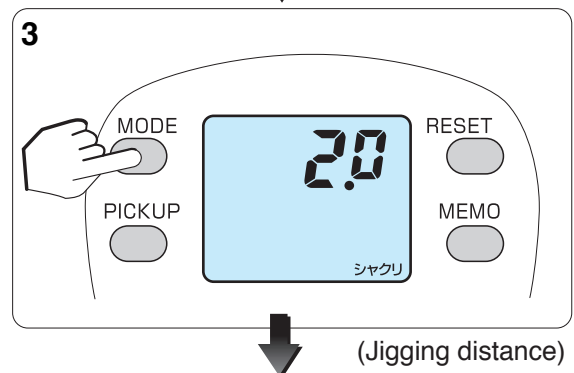

4. In the same manner, set length, waiting time and range.

By pressing the **PICKUP BUTTON** during the jigging setting display, the display will show depth and begins jigging.

Pressing and holding the **MODE BUTTON** will quickly scroll you back to the depth counter display.

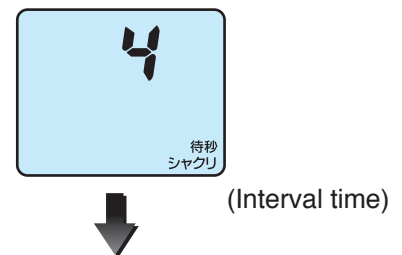

5. After pressing the **PICKUP BUTTON**, use the power lever to start jigging.

Jigging speed is controlled with the power lever.

As the jerking starts, **シヤクリ** indicator blinks.

Pressing the **PICKUP BUTTON** again stops jigging.

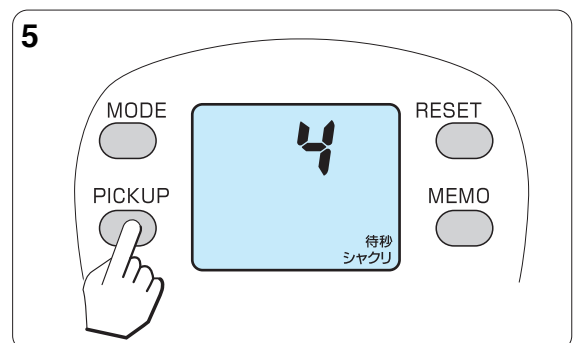

Functional setting operation (8. Jigging)

Jigging master

You can choose the jigging pattern, range, waiting time and length you require.

- Pressing the **PICKUP BUTTON**, starts jigging, with the display showing the **シヤクリ** indicator. (Pressing the button once more cease jigging.) The power lever controls jigging speed.
- Shifting of jigging speed is done easily with the lever control.
- When a fish strikes during jigging, pull the power lever to OFF position. And it turns jigging function off and allows the normal winding with power lever.
- To show the jigging display, refer to page 16.

1. Jigging pattern

You can choose the number of steps you wish for your jigging pattern.

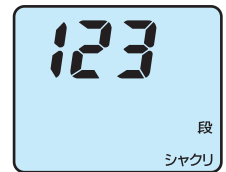

(Preference setting)

Master jigging	One-step jigging	Two-step jigging	Three-step jigging

Master jigging (123) is the method in which the number of jigging steps is selected automatically by the computer.

A : 4 seconds stop
B : 0.4 seconds stop

2. Jigging length

You can choose the length of the line wound up in one jig action. (Depending upon the sinker, speed of winding, the jigging length may overrun its setting slightly.)

The length can be set in increments of 50 cm between 0.5 and 10 m.

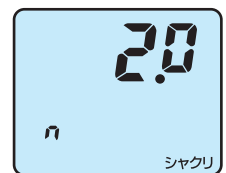

(Preference setting)

Functional setting operation (8. Jigging)

3. Waiting time

You can choose the waiting time between jigs. The interval time is set in seconds.

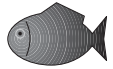

Example

Three-step jigging
5 seconds interval time

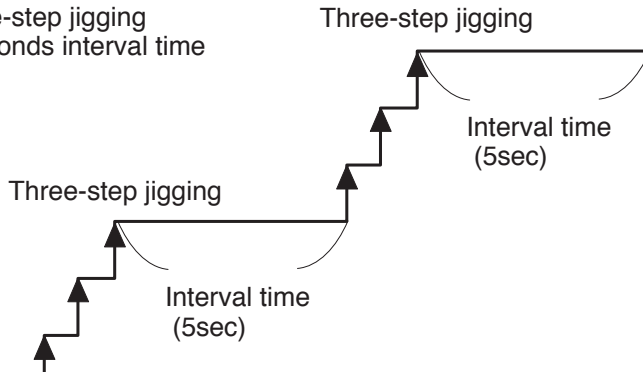

(Preference setting)

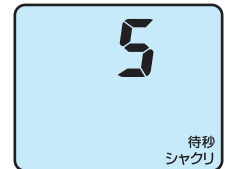

(Shown is the interval time set to 5 sec)



- If jigging time is longer than the chumming timer setting, then the chumming timer setting takes priority and will wind up the line.



4. Jigging range

The depth range for jigging is set in 1 m increments. If the range is set to zero, then jigging continues right up to the auto stop depth.

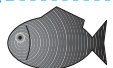

Example

Range is 20 m.

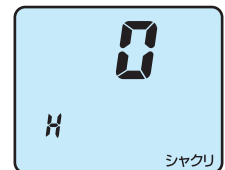
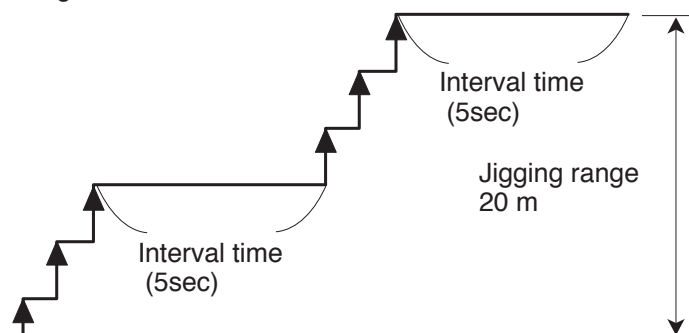

(Preference setting)



(Shown is the jigging range set to 20m)

Functional setting operation (9.Chumming timer)

Chumming timer

The display indicates precisely how many minutes (seconds) passed after a tackle is dropped. It is very helpful to make a base fishing action.

- The display indicates how many minutes (seconds) passed after you start dropping a tackle. You can roughly estimate when you should let out chum or collect the tackle.
- The Chumming timer automatically starts from 7.0 m on the water surface counter if no layer is memorized.

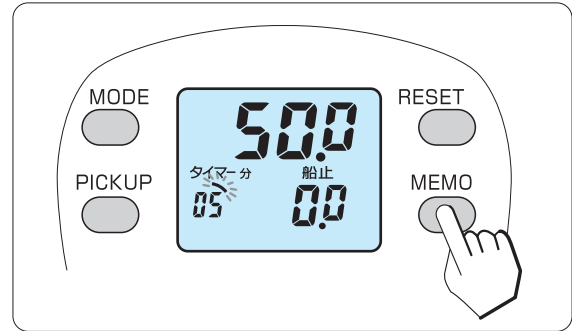

*Seconds are indicated when passed time is within one minute, and minutes are indicated when passed time is larger than 1 minute.



Attention

When you press **MEMO BUTTON** on the way, the timer indication starts from "0.0".

Chumming timer winding

Even a beginner can handle a professional fishing action. Just set time, and the reel automatically starts winding.

- When you set 5 minutes as waiting time for one-time casting, the reel automatically winds up a tackle at high speed for fishing action after 5 minutes pass from the starting point of the timer.
- When the Chumming timer winding is set, **タイマー** on the LCD lights up. To cancel it, set "0", and **タイマー** blacks out.
- To check the set time, press **MEMO BUTTON**.
- The Chumming timer winding setting is available all the time except in the process of auto winding.

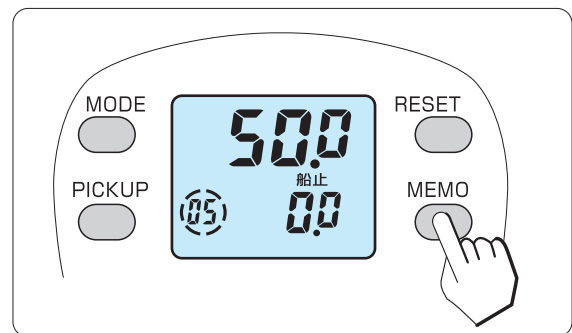

Functional setting operation (9. Chumming timer)

1. Press **MODE BUTTON** to display the **タイマー** setting screen.

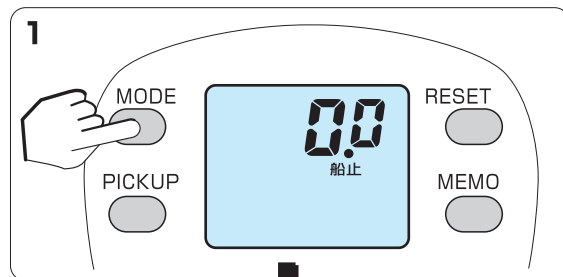

Even a beginner can handle a professional fishing action. Just set waiting time, and the reel is automatically activated for winding. You can fish more effectively and easily.

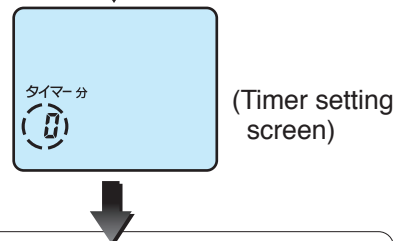

2. Set a value (minutes) with the power lever.

(The figure shows a case where 3 minutes are set for winding.)

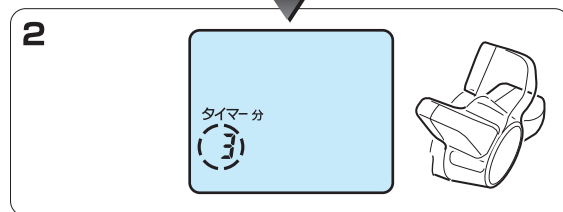

3. Press **MODE BUTTON**.

-When the surface depth screen appears, the setting procedure is completed.

- **タイマー** lights up on the screen.

-You can check the set time by pressing **MEMO BUTTON**.

-When you keep pressing **MODE BUTTON** for a long time, the screen switches at fast speed, and returns to the surface depth screen.

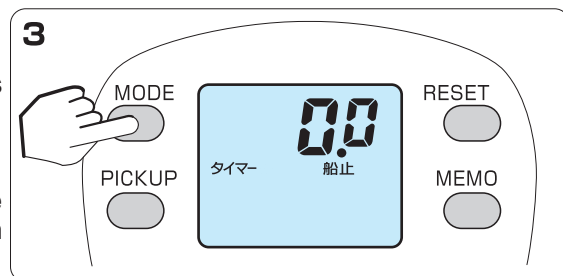

4. When the set time arrives, the reel automatically winds up the tackle at Hi speed.

-The alarm sounds before the reel starts winding.

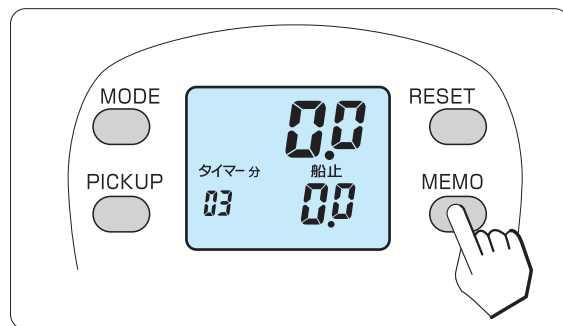

Functional setting operation (10. Display recalibration)

Display revision

You can recalibrate the counter should it not indicate an accurate depth compared to depth markings on your line.

Example right is the case in which, though the counter shows 103 m, color markings on the line indicate 100 m.

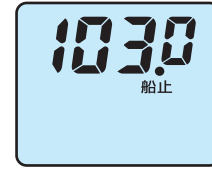

1. Press **MODE BUTTON** six times to show on the display real fishing time and total winding length.

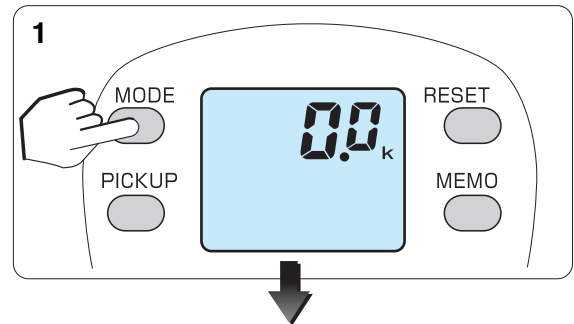

2. Press **MODE BUTTON** and **RESET BUTTON** at the same time for 2 seconds. This displays revision display.

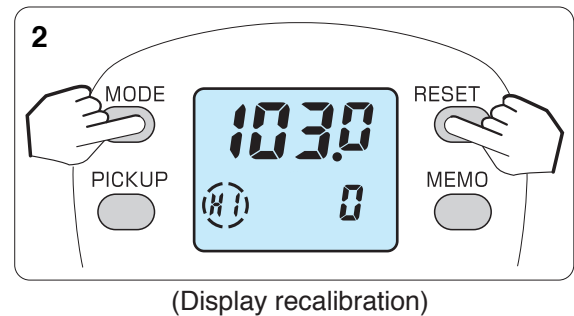

3. Move the power lever to change the display's reading to **100.0**. (Occasionally, for the revision rate, the exact number cannot be attained.)

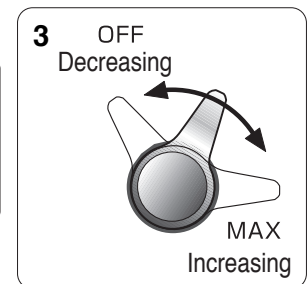

4. After **100.0** is reached, then press the **MODE BUTTON** to return to depth display.

With this procedure, the inverse counter is reset. In the revised display, pressing of the **RESET BUTTON** changes the reading back to the unrevised value.

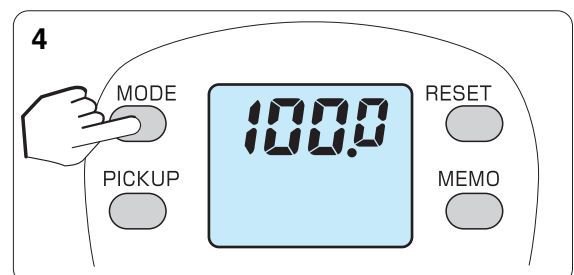

Useful functions

Various alarms

Many kinds of information are indicated by audible alarms.

Power lever alarm

- Placing the Power lever at MAX or OFF positions evokes an alarm.



Auto stop alarm

- While winding up, starting 6 m below the auto stop depth, an alarm beeps at two meter intervals. Upon reaching the auto stop depth, a long alarm sounds.

Range memory alert

-While lowering your rig back into the strike zone, starting 6 m above the memorized strike depth, an alarm sounds at two m intervals with a long alarm sounding once the target depth is reached.

(This range memory alarm does not sound unless line has been wound more than 6 m above the memorized depth.)

Switch alarm

-Each time a button is pressed, a confirming beep is sounded.

Bite alarm

-The alarm sounds when Clutch is OFF, Drift is ON, and the reel detects movement faster than the set sensitivity level. It also sounds when Clutch is ON, the drag is slipped, and the line is pulled out.

Timer alarm

-Chumming timer winding is indicated by an alarm.

Drift/Click alarm

-The alarm sounds (beeps) every time when 1 m of the line goes out, so that you can recognize the line capacity by the sound.

Display light

Backlighting of the display provides easy reading for early morning or night fishing.

Backlighting of the display provides easy reading for early morning or night fishing.

-As long as the reel is connected to a power source, the display backlight is on.

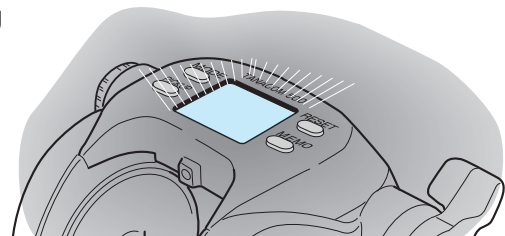

Breaker display

-For safety, an excessively heavy load on the reel will activate the circuit breaker system and stop automatic winding. While this system is working, the display appears as shown on the right.

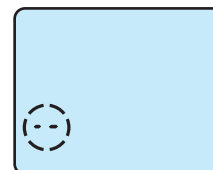

Reel Specifications

Reel Specification list

Product name		TANACOM 500	
Gear ratio(manual winding)		2.8 : 1	
Weight		750 g / 26.4 oz	
Max Drag power		10 kg/22 lb	
Line Capacity		PE(BRIGHT)	NYLON MONOFILAMENT
		PE4 (46 lb)-470 m (510yds)	5 (20 lb)-420 m (450yds)
		PE5 (62 lb)-350 m (380yds)	6 (24 lb)-330 m (360yds)
		PE6 (69 lb)-300 m (320yds)	7 (28 lb)-300 m (320yds)
		PE8 (93 lb)-220 m (240yds)	8 (32 lb)-240 m (260yds)
Number of Ball bearings		6	
Power-supply voltage		DC 12 V – 16.8 V	
Electric current (Amps)	No load	4 A	
	stall	8 A	
	Max	11 A	
Speed shifting	No load	0 – 170 m / min (continuous shifting)	
Instant max winding power		43 kgf	

**This reel is exclusively for PE lines. Please do not use nylon or fluorocarbon lines as these may damage the spool.*

Counter display

Depth display range	Upper counter; 0.0 – 999.9 m Lower counter : -99.9 – 999.9 m
Usable temp. range	-10 to +60 (degrees centigrade)

Specifications may be changed without prior notice for the purpose of improvement.

Parts List

TANACOM 500

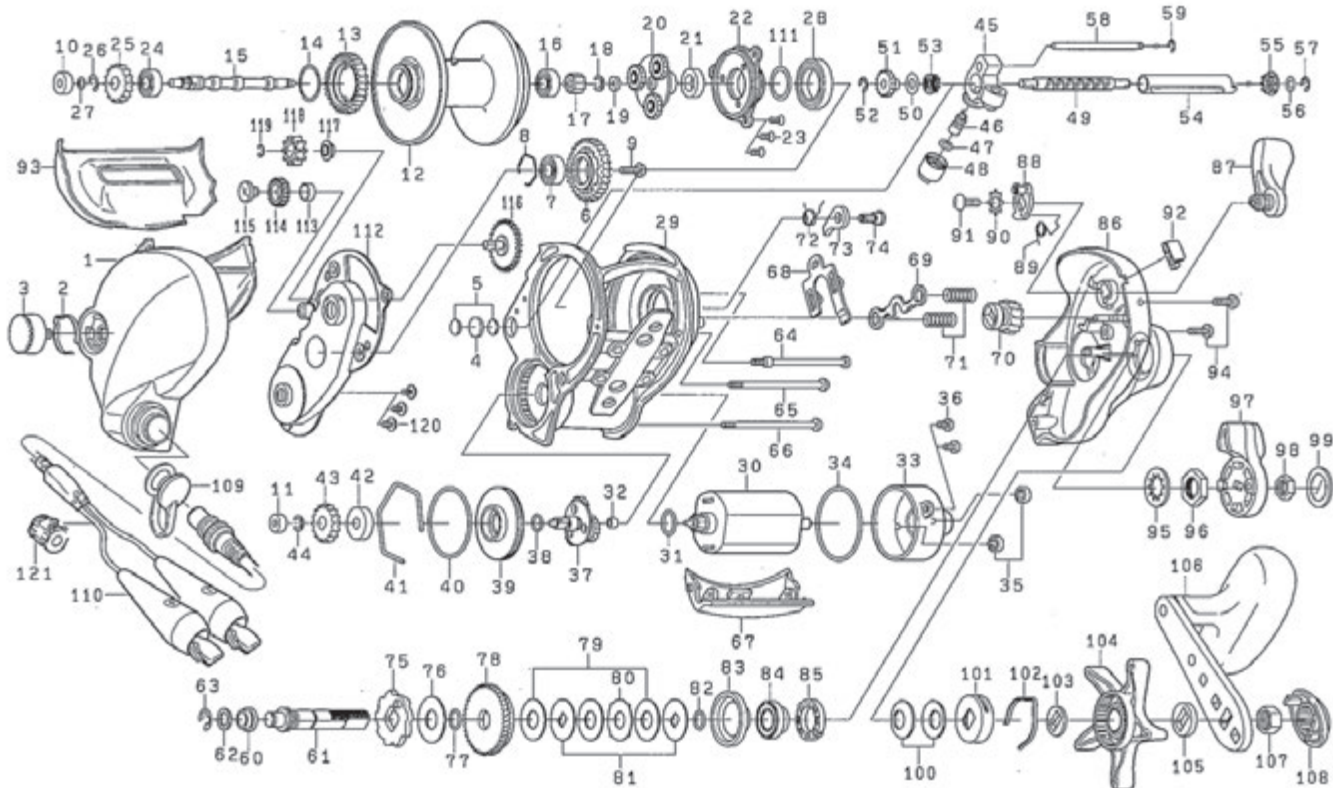

TANACOM 500

No.	Parts No.	Parts Name	No.	Parts No.	Parts Name	No.	Parts No.	Parts Name
1	6G632205	SIDE PLATE(L)	42	6B738001	BEARING	83	6F659601	PACKING
2	6E033201	LEAF SPRING	43	6G087501	GEAR	84	6F659701	COLLAR
3	6E489609	SCREW	44	63208702	RETAINER	85	6F659801	BEARING
4	6B175503	WASHER	45	6G580701	LEVEL WIND AS	86	6J415301	SIDE PLATE(R) AS
5	63757405	WASHER	46	61220602	PIN	87	6F469006	LEVER
6	6F462901	GEAR	47	6F950200	WASHER	88	6F469201	PLATE AS
7	6B181602	BALL BEARING	48	6E354101	NUT	89	6G341101	SPRING
8	6F463001	RING	49	6G580801	WORM SHAFT	90	61608001	TOOTHED WASHER
9	63538207	SCREW	50	63716904	WASHER	91	63538212	SCREW
10	6G375601	BEARING	51	6F658201	GEAR	92	6E286001	LINE STOPPER
11	6E280201	BEARING	52	63205901	RETAINER	93	6F469620	FINGER COVER
12	6J415101	SPOOL AS	53	6F467201	COLLAR	94	6G876302	SCREW
13	6F656901	GEAR	54	6F467301	PIPE	95	6F285901	TOOTHED WASHER
14	6F657001	RING	55	6F467201	COLLAR	96	6F303102	NUT
15	6H565801	MAIN SHAFT	56	6B411702	WASHER	97	6F429702	LEVER AS
16	6G536001	BALL BEARING	57	63205901	RETAINER	98	63424004	NUT
17	6F463901	GEAR	58	6F467401	PILLAR	99	6F430005	CAP
18	6F550501	RETAINER	59	6B864101	RETAINER	100	6F673601	SPRING WASHER
19	6G077201	BEARING	60	6F716101	BEARING	101	6F470002	CAP
20	6G632301	METAL AS	61	6F725501	GEAR SHAFT	102	6B747702	LEAF SPRING
21	6G007401	BEARING	62	6F481201	COLLAR	103	6F470101	WASHER
22	6G579901	PLATE	63	63207601	RETAINER	104	6F470209	STAR DRAG
23	6B395503	SCREW	64	6F541701	SCREW	105	6H636501	COLLAR
24	6G536001	BALL BEARING	65	6F467601	SCREW	106	6J415401	HANDLE AS
25	6G087501	GEAR	66	6F467602	SCREW	107	6B862102	NUT
26	63208702	RETAINER	67	6F467726	MOTOR COVER	108	6F471205	CAP
27	6B411700	WASHER	68	6F467801	SLIDE PLATE	109	6F661001	CAP
28	6E292702	BALL BEARING	69	6E252102	CLUTCH PLATE	110	6G868701	CORD
29	6J415201	FRAME AS	70	6G581201	PINION	111	6F682600	WASHER
30	6G116602	MOTOR AS	71	6F935201	SPRING	112	6F462201	SET PLATE
31	6B055201	O-RING	72	6F673401	SPRING	113	6F540701	COLLAR
32	6F024901	BEARING	73	6F468101	STOPPER	114	6F462301	GEAR
33	6F465701	MOTOR HOLDER AS	74	6F658701	SCREW	115	6F113401	SCREW
34	6F465901	O-RING	75	6E290801	RATCHET AS	116	6F462404	GEAR AS
35	6F657501	PACKING	76	63746604	WASHER	117	6F462701	COLLAR
36	63511801	SCREW	77	6F657801	O-RING	118	6F462802	GEAR
37	6G087601	METAL AS	78	6F725601	DRIVE GEAR	119	6B864101	RETAINER
38	6F657801	O-RING	79	6F659302	WASHER	120	6H080501	SCREW
39	6G087801	PLATE	80	6F659404	WASHER	121	6G905401	FERRITE CORE
40	6F274501	O-RING	81	6F659505	WASHER			
41	6F466601	RING	82	6F657801	O-RING			

*1: Part No. 6G8121022 is applied to the U.S. model.

*2: Part No. 116 is only applied to the European Model.

There may sometimes be a difference between the purchased reel and the Dismantled Parts Chart or the parts list above due to the adjustment process etc. We appreciate your understanding.

Trouble shooting

Symptom	Possible causes	To do	Ref. page
Motor does not respond to the power lever.	The counter displays 0.0 m.	It is a normal function to avoid over winding. Press RESET BUTTON to continue winding.	19,20
	Did not pull the lever to OFF position.	Pull the lever to OFF and then move forward again to start winding.	9
	Unstable power source.	Use another power source, such as electric reel specific batteries.	2
Counter display does not appear.	Battery charge is low.	Recharge the battery.	3
	Cord worn or corroded.	Replace the cord.	5
	Incorrect battery connection.	Connect correctly.	2
Inverse counter does not appear.	Did not press PICKUP BUTTON .	It is normal. Press MEMO BUTTON	22
Jigging function does not respond.	Power lever is at OFF.	Push the lever forward.	23
	Pickup mode is selected.	With MODE BUTTON , select the jigging mode.	25-27
The reel jigs on its own.	Low power voltage.	Replace with a recharged battery.	3
Auto stop function does not work.	Did not press RESET BUTTON at surface.	Press RESET BUTTON to reset depth to zero with rig at the surface.	18
	Error for sinker weight or rocking of the boat.	Adjust settings of auto stop function.	19,20
	Line is elongated.	Reset the depth counter at the surface.	18
There are counter errors.	Line length has increased due to stretching.	<ul style="list-style-type: none"> - Reset the counter. - Revise the display. - Re-enter line data. 	18 30 10-15
Pickup does not respond.	Speed setting is at zero.	Press MODE BUTTON to select winding speed setting.	21

Contact your dealer if the reel does not function properly despite the above details being confirmed, in the event of other problems arising, and to order parts.

Reference/Référence/Hinweis Instrucciones/Riferimenti

COMPANY NAME	DAIWA SPORTS LIMITED
ADDRESS	Netherton Industrial Estate, Wishaw ML2 0EY, Lanarkshire, Scotland, U.K.
TEL NO.	01698-355-723
Web Address	http://www.daiwasports.co.uk/

COMPANY NAME	DAIWA FRANCE S.A.S
ADDRESS	25 BOULEVARD INDUSTRIEL BP 30208 76304 SOTTEVILLE LES ROUEN CEDEX. FRANCE
TEL NO.	02-32-91-96-50
Web Address	http://www.daiwa-france.fr/

COMPANY NAME	DAIWA CORMORAN SPORTARTIKEL-VERTRIEB GmbH
ADDRESS	Industriestrasse 28 82194 Groebenzell GERMANY
TEL NO.	08142-5005-0
Web Address	http://www.daiwa-cormoran.info/

COMPANY NAME	Daiwa Corporation
ADDRESS	11137 Warland Drive Cypress, CA 90630
TEL NO.	+1-(562) 375-6800
Web Address	http://www.daiwa.com/

COMPANY NAME	Daiwa Australia Pty. Ltd
ADDRESS	Unit K, 134 – 140 Old Pittwater Rd, Brookvale NSW 2100
TEL NO.	+61 (02) 8644 8644
Web Address	http://daiwafishing.com.au/

LIMITED WARRANTY TERMS

WARRANTY WILL EXPIRE WHEN ONE OF THE FOLLOWING HAS BEEN SURPASSED.

*ONE YEAR FROM DATE OF ORIGINAL PURCHASE.

*200 TOTAL HOURS OF USE.

GARANTIE

LA GARANTIE EXPIRE LORSQUE L'ON ATTEINT

*SOIT 1 AN APRES L'ACHAT

*SOIT 200 H D'UTILISATION

TERMINOS DE GARANTÍA LIMITADOS

La garantía caducará cuando algo de lo siguiente se haya sido superado.

*Un año de la fecha de la compra original

*200 horas totales de uso