

POWER[®]
QUEEN

MINI (100A BMS)

12.8V

100Ah

Product Manual



www.ipowerqueen.com



service@ipowerqueen.com

PRODUCT OVERVIEW

📦 12.8V 100AH BATTERY

Operating Voltage: 12.8V

Charging Voltage: 14.4±0.2V

Recommend Charge Current: 20A (0.2C)

Max Continuous Discharge Current: 100A

Max. Continuous Output Power: 1280W

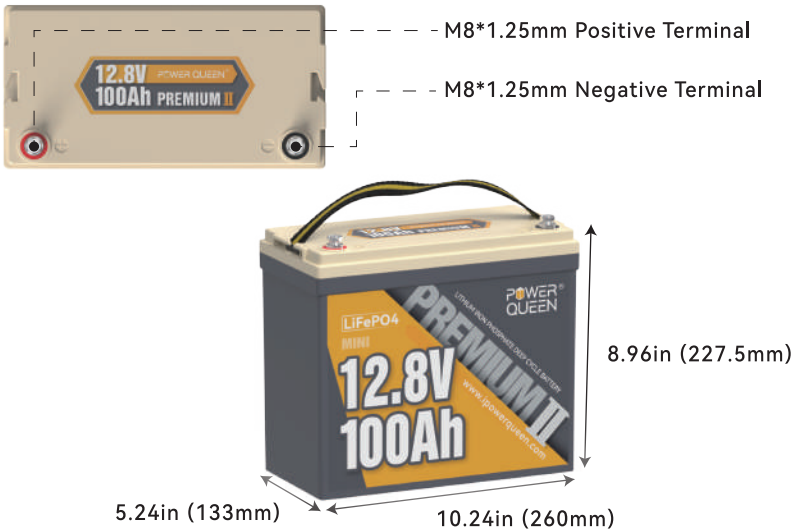

ADDITIONAL COMPONENTS

📦 M8- 35/64" (14MM) TERMINAL BOLTS

The terminal bolts are used to secure multiple cable lugs to a single battery terminal. The bolts can be replaced with **M8** bolts of other lengths based on actual needs.

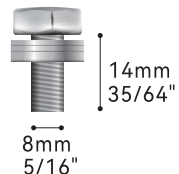

📦 INSULATING CAPS FOR BOLTS

IMPORTANT SAFETY INSTRUCTION

- 1. Please keep the battery away from heat sources, sparks, flames, and hazardous chemicals.**
- 2. Maintain Adequate Ventilation and Heat Dissipation**

Place the battery in a well-ventilated area with sufficient heat dissipation to prevent overheating and damage.
- 3. Size the Battery Cables and Connectors Appropriately**

Use high-stranded copper connectors and heavy gauge cables to handle possible battery loads. Make sure to keep identical cable lengths.
Avoid accidents caused by unsuitable connectors or cables that make the connection a heat source during battery operation.
- 4. Please tighten all cable connections, as loose cable connections can cause terminal meltdown or fire.**
- 5. DO NOT puncture, drop, crush, burn, penetrate, shake, or strike the battery.**

The battery should be securely fastened during handling to prevent impact or dropping.
It should be safely secured to a solid plane and the cables safely tied to a suitable location to avoid arcing and sparking due to friction.
DO NOT press it by placing heavy stuff on top of it for long periods, which may damage it due to an internal short circuit.
- 6. DO NOT immerse the battery in water whether the battery is in use or on standby.**
- 7. DO NOT open, dismantle, or modify the battery.**
- 8. DO NOT touch the exposed electrolyte or powder if the battery casing is damaged.**
- 9. Uncovered electrolyte or powder that has contacted the skin or eyes MUST be flushed out with plenty of clean water immediately. Seek medical attention afterward.**
- 10. Avoid Short Circuit**

Please use circuit breakers, fuses, or disconnects that have been properly sized by certified electricians, licensed installers, or regional code authorities to protect all the electrical equipment in your system. The battery has a built-in battery management system (BMS) that protects the battery cells from over-charge, over-discharge, and over-current, however this alone will not protect your system from severe electrical conditions.

11. Trained and certified technicians are required for safe and reliable installation. This product manual can only serve as a guideline as it cannot cover all possible scenarios.

12. Verify Correct Polarity

Please verify the polarity before connecting the wiring. Reverse polarity can and will destroy the battery and other electrical equipment. Use a multimeter to determine proper polarity.

13. Avoid Exposed Metal Terminals or Connectors

The terminals of this battery are always live. Avoid exposed metal terminals or connectors; DO NOT place tools on the terminals or touch them with bare hands; DO NOT short circuit or use outside of specified electrical ratings.

14. DO NOT dispose of the battery as household waste. Please use recycling channels in accordance with local, state, and federal regulations.

WARNING

1. Batteries are potentially dangerous and proper precautions must be taken during operation and maintenance.
2. Improper use of the battery can lead to battery failure or other potential damage.
3. Improper configuration, installation, or use of related equipment in the battery system may damage the battery and other related equipment.
4. Please wear proper personal protective equipment when working on the battery.
5. Battery installation and maintenance must be performed by trained and certified technicians.
6. Failure to follow the warnings above can result in potential damage.

If you have any questions or need any help, please feel free to contact us (and leave your contact phone number) at service@ipowerqueen.com, we will offer phone or email support in 12hrs.

CONTENTS

01 BATTERY PARAMETERS

03 THINGS TO KNOW BEFORE USING

Page 03 Long Term Storage

04 CHARGING METHODS

Page 04 Solar Panel(s) & Controller

Solar Panel

Controller

Controller Settings

Method I

Page 05 Battery Charger

Method II

Page 05 Alternator / Generator

Method III

06 HOW TO ESTIMATE THE BATTERY CAPACITY

Page 06 State of Charge (SOC)

07

RECOMMENDED CABLE SIZING

08

SERIES / PARALLEL CONNECTIONPAGE

Page 08

The Premise of Connection

Page 08

Limitation for Series/Parallel Connection

Page 09

How to Connect Batteries

Step 1 Wear Insulating Gloves

Step 2 Voltage Balancing Before Connection

Step 3 Battery-to-Battery Connection

Step 4 Rebalancing Every Six Months

Rebalancing Every 6 Months

Wiring Diagram Reference

15

WHAT TO DO WHEN THE BATTERY STOPS WORKING?

BATTERY-PACK

MAIN PARAMETERS

Item	Parameter
Cell Type	LiFePO ₄
Nominal Voltage	12.8V
Rated Capacity	100Ah
Energy	1280Wh
Internal Resistance	≤40mΩ
Cycle Life	≥4000 times
Battery Management System (BMS) Board	100A
Charge Method	CC/CV
Charge Voltage	14.4±0.2V
Recommend Charge Current	20A (0.2C)
Max. Continuous Charge Current	100A
Max. Continuous Discharge Current	100A
Max. Discharge Current 1 Second	400A
Max. Continuous Output Power	1280W

Item	Parameter
Dimension	L10.24*W5.24*H8.96 inch
	L260*W133*H227.5 mm
Housing Material	ABS (Flame Retardant Plastic)
Protection Class	IP65
Temperature Range	Charge: 0°C to 50°C / 32°F to 122°F
	Discharge: -20°C to 60°C / -4°F to 140°F
	Storage: -10°C to 50°C / 14°F to 122°F

THINGS TO KNOW

BEFORE USING

When using the battery, please be careful to **avoid metal or conductive objects touching the positive** and negative poles of the battery **at the same time**, otherwise it may cause a short circuit.

The battery can be mounted in every direction even upside down, but be sure to keep the battery post bolts free from any weight pressure.

Tightly screw in the post bolts. Having loose battery terminals will cause the terminals to build up heat resulting in damage to the battery.

This battery is not intended to be used to start any devices, please **DO NOT** use it as a starting battery.

Suggestions for Long-term Storage

Temperature

The battery can be operated at a temperature of -20°C to 60°C / -4°F to 140°F , and a temperature between **10°C to 35°C / 50°F to 95°F** is ideal for long-term storage. Store in a fireproof container and away from children.

Capacity

For a longer-lasting product, it is best to store your battery **at a 50% charge** level and recharge every three months if it is not going to be used for a long time.

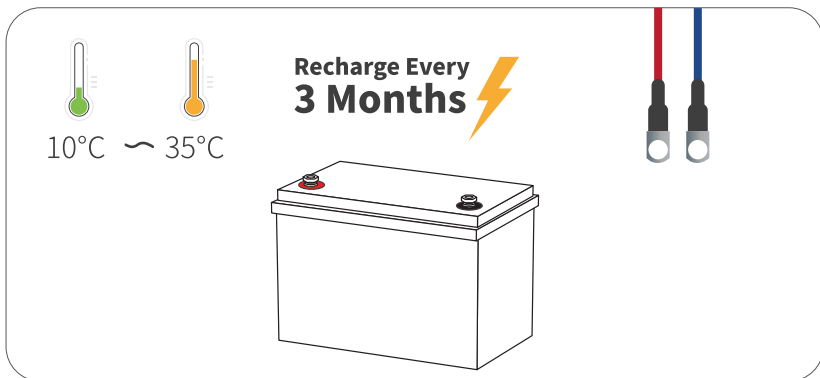

CHARGING METHODS

SOLAR PANEL(S) & CONTROLLER

Solar Panel

Recommend Power: $\geq 400W$

- The battery can be fully charged in one day (with effective sunshine 4.5hrs/day) by 400W solar panels.
- It may take more than one day to fully charge the battery by $\geq 400W$ solar panels since the duration and intensity of light would be a great factor for their charging efficiency.

Controller

Recommend Charging Mode: 12V (14.6V) LI (LiFePO4)

Recommend Charging Current:

20A (0.2C) The battery will be fully charged in around 5hrs to 100% capacity.

50A (0.5C) The battery will be fully charged in around 2hrs to around 97% capacity.

Controller Settings

Refer to the below parameters if you need to manually set up your controller.

As different types of batteries have different charging modes, **it is recommended to set only the following parameters for LiFePO4 batteries.** The settings for other types of batteries do not apply to LiFePO4 batteries except for the following settings

CHARGING	Charge /Bulk /Boost Voltage	14.4 \pm 0.2V
	Absorption Voltage	14.4 \pm 0.2V
	Over Voltage Disconnect	15V
	Over Voltage Reconnect	14.2V
	Tail Current	2A (0.02C)
DIS- CHARGING	Under Voltage Warning	11.6V
	Under Voltage Recover	12V
	Low Voltage Disconnect	10.8V
	Low Voltage Reconnect	12.4V

BATTERY CHARGER

Use 14.6V lithium iron phosphate (LiFePO₄) battery charger to maximize the capacity.

Recommend Charging Voltage: Between **14.2V to 14.6V**

Recommend Charging Current:

20A (0.2C) The battery will be fully charged in around 5hrs to 100% capacity.

50A (0.5C) The battery will be fully charged in around 2hrs to around 97% capacity.

Tips

- ① Connect the charger (with alligator clips) to the grid power before connecting it to the battery in case of sparks.
- ② It's recommended to disconnect the charger from the battery after fully charging.

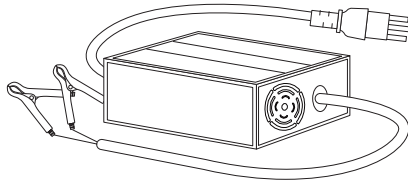

ALTERNATOR / GENERATOR

Power Queen battery can be charged by an alternator or generator, and it needs to connect a **DC to DC** charger between the battery and the alternator or generator.

Recommend Charging Voltage: Between **14.2V to 14.6V**

Recommend Charging Current:

20A (0.2C) The battery will be fully charged in around 5hrs to 100% capacity.

50A (0.5C) The battery will be fully charged in around 2hrs to around 97% capacity.

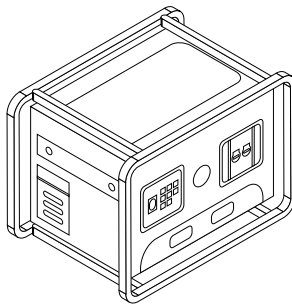

HOW TO ESTIMATE

THE BATTERY CAPACITY

📦 STATE OF CHARGE (SOC)

The battery capacity could be roughly estimated by its **resting voltage (not charging/discharging voltage)**.

Since the voltage of each battery is slightly different, and the voltage measurement is affected by the measuring instrument, ambient temperature, etc., **the following parameters are for reference only**. The actual SOC of the battery is based on the discharge capacity under load.

Resting Voltage: The voltage is measured after the battery has been disconnected from the charger and loads with zero current, and left alone for 3 hours.

VOLTAGE(V)

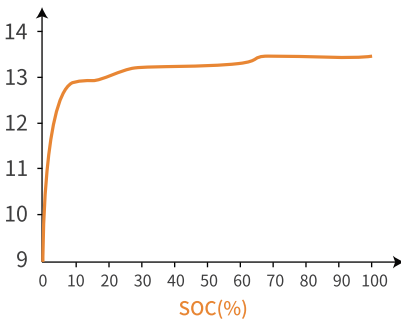

SOC (%)	VOLTAGE (V)
0	10 to 12
25	13 to 13.15
50	13.15 to 13.2
75	13.3 to 13.33
100	≥13.33

① Based on the characteristics of LiFePO₄ batteries, the voltage measured by all LiFePO₄ batteries during charging/discharging is not the real voltage of the battery. Therefore, after charging/discharging and disconnecting the battery from the power source, the voltage of the battery will gradually drop/increase to its real voltage.

RECOMMENDED CABLE SIZING

Battery cables should be properly sized to handle the expected load. Refer to the table below for amperage ratings for different sizes of copper cables.

PVC COPPER CABLE SIZE (AWG/MM2)	AMPACITY (A)
14 (2.08)	20
12 (3.31)	25
10 (5.25)	35
8 (8.36)	50
6 (13.3)	65
4 (21.1)	85
2 (33.6)	115
1 (42.4)	130
1/0 (53.5)	150
2/0 (67.4)	175
4/0 (107)	230

The above values are from NEC Table 310.15(B)16 for copper cables rated at 167°F (75°C) operating at an ambient temperature not exceeding 86°F (30°C). Cables longer than 6 feet (1829 mm) or ambient temperature higher than 86°F (30°C) may require heavier gauges to avoid excessive voltage drops with undersized ones.

SERIES/

PARALLEL CONNECTION

THE PREMISE OF CONNECTION

To connect in series or /and parallel, batteries should meet the below conditions:

- identical batteries with the same battery capacity (Ah) and BMS (A);
- from the same brand (as lithium battery from different brands has their special BMS);
- purchased in near time (within one month).

LIMITATION FOR SERIES/PARALLEL CONNECTION

Support connecting **up to 16 identical batteries** for up to:

4 in series as **48V (51.2V)** battery system/

4 in parallel as **400Ah** battery system.

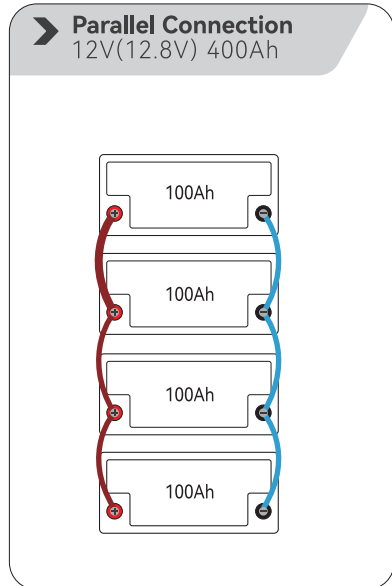
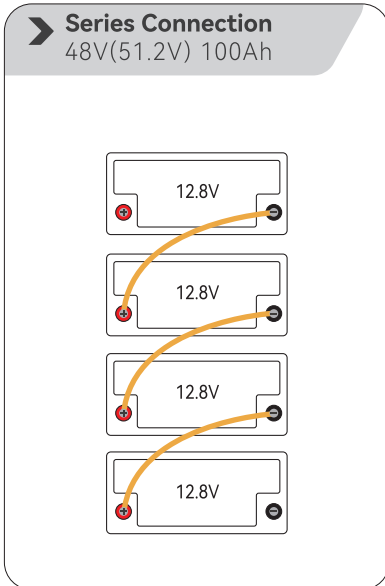

HOW TO CONNECT BATTERIES

Step1 Wear Insulating Gloves

Wear Insulating Gloves for protection before connecting. Please pay attention to operation safety in the process of connection.

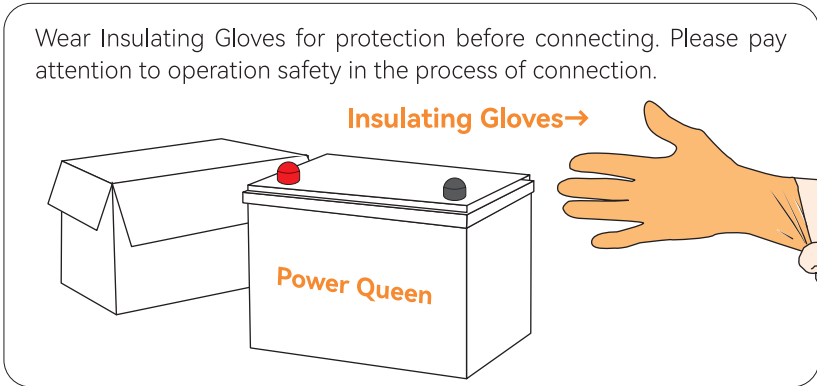

Step2 Voltage Balancing Before Connection

Below two steps are necessary to reduce the voltage difference between batteries and let the battery system perform the best of it in series or/ and in parallel.

➤ Step①

Fully charge the batteries separately.
(voltage at rest: $\geq 13.33V$)

➤ Step②

Connect all of the batteries **in parallel**, and leave them together for **12~24hrs.**

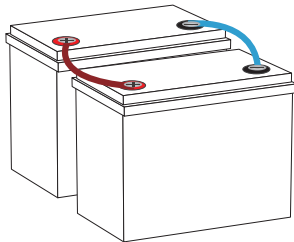

➤ Step③

They're now ready for the **connection.**

Step3 Battery-to-Battery Connection

#1 Connect Batteries in Series

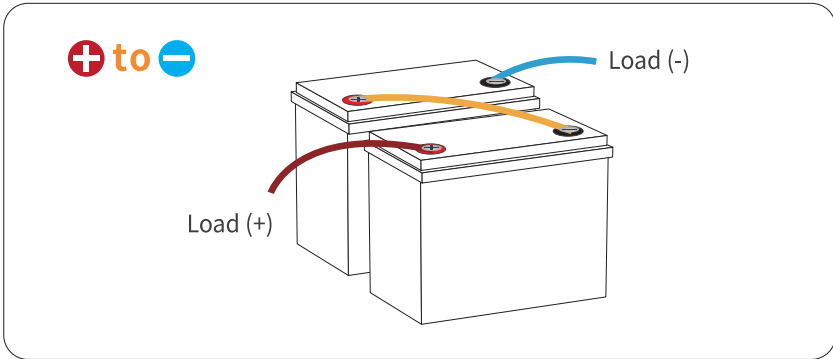

After series connection, the **voltage** of the battery system will be doubled according to the number of batteries you connect.

E.g. If two 12V 100Ah batteries are connected in series, the battery system will be 24V (25.6V) 100Ah.

#2 Connect Batteries in Parallel

Refer to Page 12 for total input & output connection

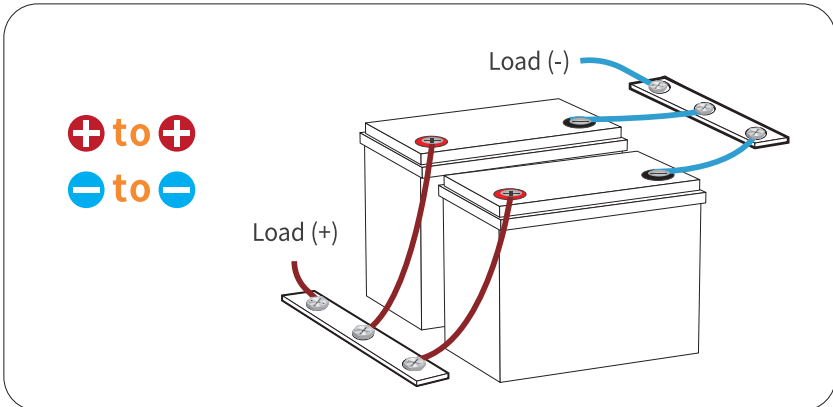

After parallel connection, the **capacity** of the battery system will be doubled according to the number of batteries you connect.

E.g. If two 12V 100Ah batteries are connected in parallel, the battery system will be 12V (12.8V) 200Ah.

#3 Connect Batteries Both in Series & Parallel

Connect in parallel first, then series.

➤ Step①

Connect the batteries in **parallel**.

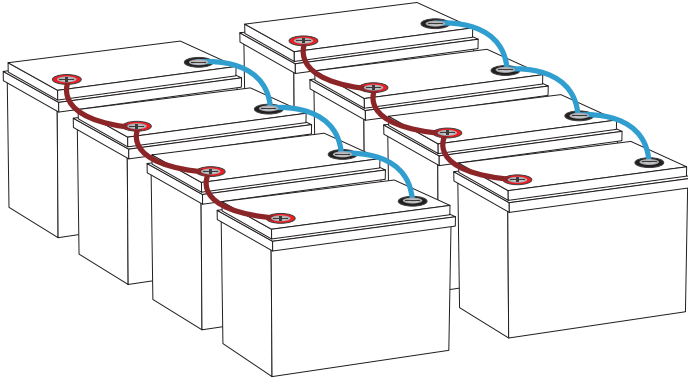

➤ Step②

Connect the paralleled battery systems in **series**.

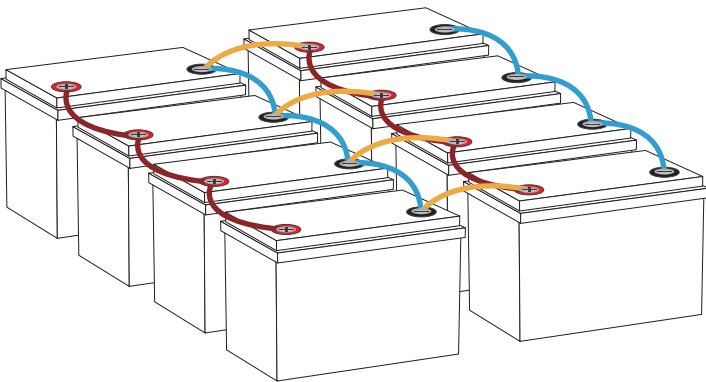

Step4 Total Input & Output Connection

Use two **copper bars** (instead of battery terminals) to connect all the positive and negative output/input cables, ensuring that the input & output currents of each battery are balanced. (Not required when connecting batteries only in series.)

It is not recommended to use one terminal as the total positive or negative output/input of the battery system as the connected terminals may heat up or even melt if the total output/input current of the battery system is too high.

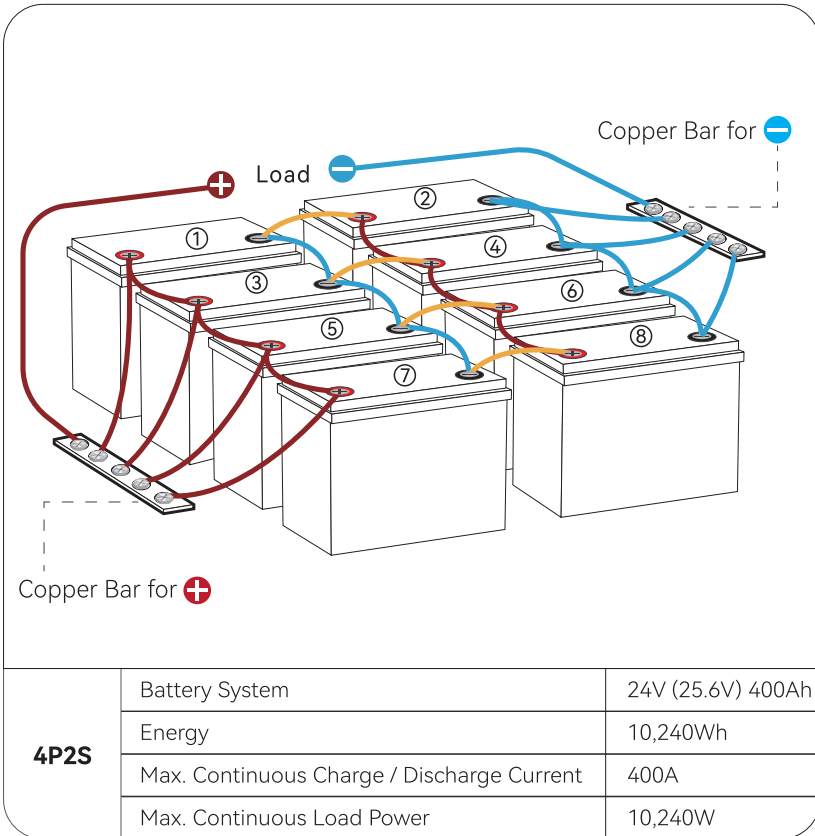

① As **-** of ① / ③ / ⑤ / ⑦ is connected in series with **+** of ② / ④ / ⑥ / ⑧, please do not connect **-** of ① / ③ / ⑤ / ⑦ with **-** of load or **+** of ② / ④ / ⑥ / ⑧ with **+** of load, otherwise the battery system will fail to connect in series.

② Please do not connect in reverse order, which may affect the use of the batteries.

Rebalancing Every 6 Months

It is recommended to rebalance the battery voltage every six months following Step 2 on Page 9 if you're connecting multiple batteries as a battery system, as there might be voltage differences after six months of the battery system running.

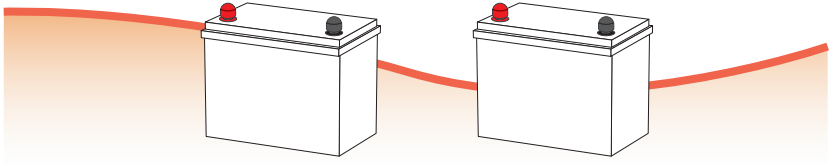

Wiring Diagram Reference

2P2S	Battery System	24V (25.6V) 200Ah
	Energy	5,120Wh
	Max. Continuous Charge / Discharge Current	200A
	Max. Continuous Load Power	5,120W

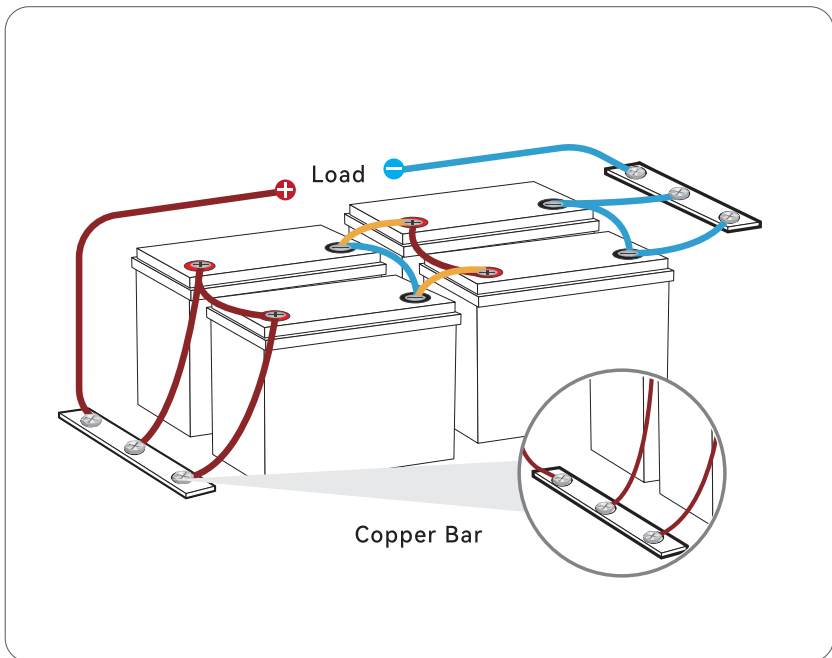

2P4S	Battery System	48V (51.2V) 200Ah
	Energy	10,240Wh
	Max. Continuous Charge / Discharge Current	200A
	Max. Continuous Load Power	10,240W

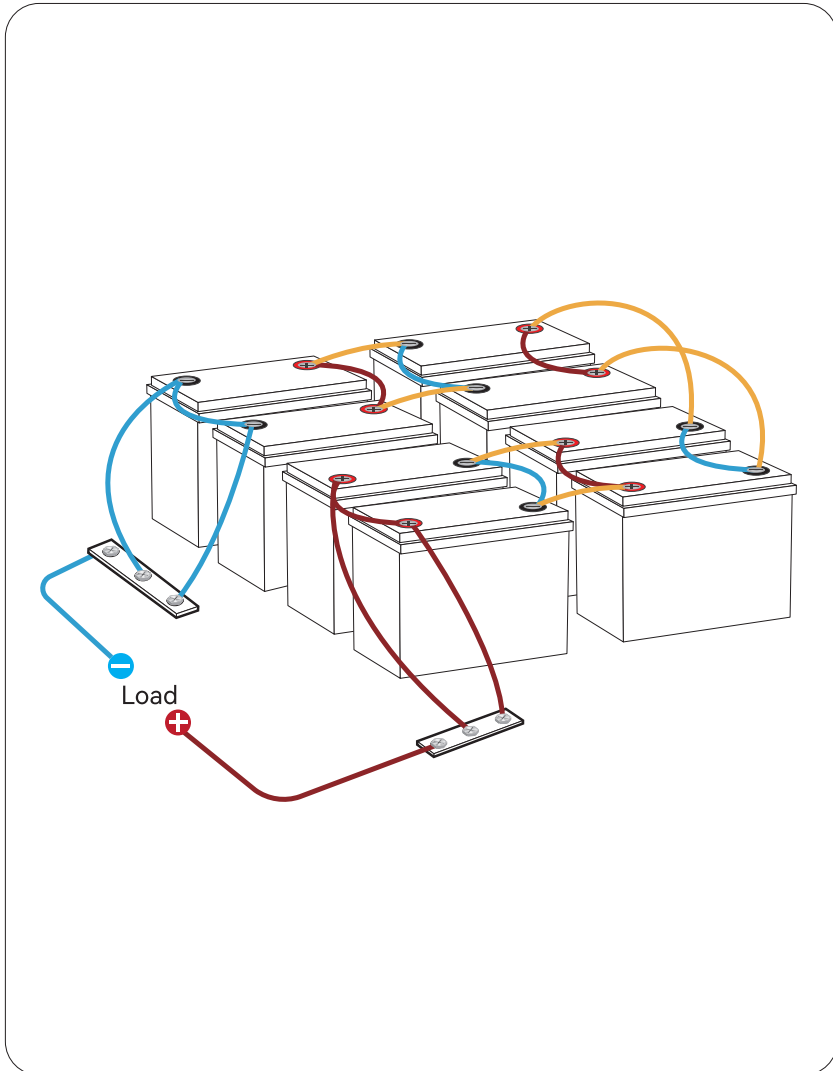

WHAT TO DO

WHEN THE BATTERY STOP WORKING?

When the battery **① can't work; ② can't be charged; ③ voltage < 9V**, it has 85% chances that BMS has shut it off for protection, and you could try one of below ways to activate the battery.

GENERAL STEPS

If the BMS has cut off the battery for protection, follow the below steps to activate it.

> Step①

Cut off all the connections from the battery

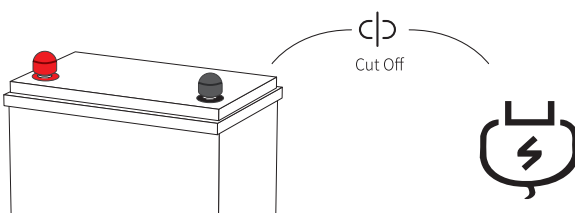

The diagram shows a battery with a red positive terminal and a black negative terminal. A curved line with a switch symbol (two vertical bars with a gap) connects the terminals to a battery icon with a lightning bolt. The text "Cut Off" is written below the switch symbol.

> Step②

Leave the battery aside for 30mins
Then the battery will automatically recover itself to normal voltage (>10V) and can be used after fully charged.

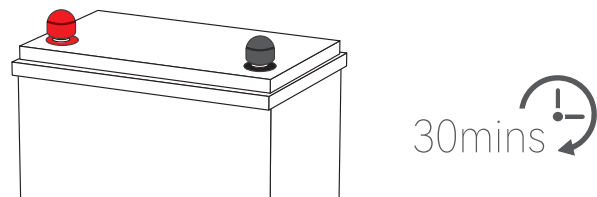

The diagram shows a battery with a red positive terminal and a black negative terminal. To the right, the text "30mins" is written next to a circular arrow icon with an exclamation mark inside.

If the battery is unable to recover itself after the above steps, please try activating by  **ONE OF THE BELOW TWO METHODS.**

After activated (voltage > 10V) and fully charged by the normal charging method, it can be used normally.

➤ Method①

Use a **charger with a 0V charging function**^① to fully charge the battery.

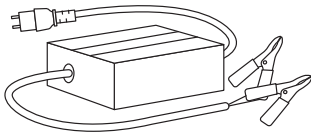

0V Charging Function
Charger

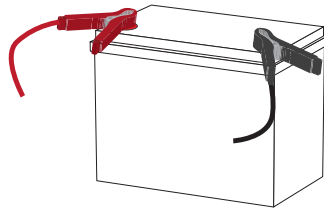

Fully Charge

① The charger can charge the battery starting from 0V.

➤ Method②

Connect a controller that supports 12V LiFePO₄ battery charging to charge the battery for 3~10s in sunny daytime.



Controller
(supports 12V LiFePO₄)

3~10s

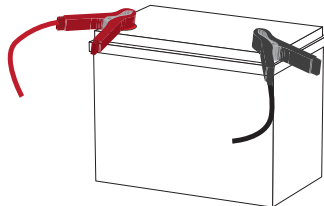

Activate & Fully Charge



POWER QUEEN[®]

Shenzhen Lizu Time Technology Co., Ltd

 service@ipowerqueen.com

 technicalsupport@ipowerqueen.com