



# LEOBRITZ 200J-L

---

Instruction Manual

# Index

Caution .....	1-7	9. Other useful functions .....	37
		Various alarms	
		Alarm sound ON/OFF setting	
		Counter lamp	
		Circuit breaker display	
		10. How to remove the handle knob .....	38
Power source .....	8,9	Reel Specifications .....	39
How to connect the power source	8	Reel Specification list	
About the power source	9	Counter display	
Battery level indicator	9	Parts List .....	40,41
Maintenance .....	10,11	Trouble shooting .....	42
About maintenance	10		
Maintenance procedures	10		
Handling and maintenance of the power cord	11		
Maintenance of the power cord	11		
Other maintenance points	11		
Names and functions of each part .....	12,13		
Names of the buttons and the display .....	14,15		
Line data input .....	16-25		
TANA sensor Bright section	16,17		
When line length is known	18-20		
Backing line input	21-23		
Line re-input	24,25		
Functional setting .....	26-38		
1. Mode setting display .....	26,27		
How to set the many functions available			
2. Before you begin fishing .....	28		
Surface depth setting			
If the main line is broken			
3. Auto stop function .....	29		
Auto stop setting			
4. Pickup speed setting .....	30		
Pickup			
Pickup speed setting			
5. Pause setting .....	31		
Pause			
Pause setting			
6. Chumming Timer .....	32		
Chumming Timer			
7. ChummingTimer winding .....	33,34		
Chumming Timer Winding			
8. Display recalibration .....	35,36		
Display revision			

## List of options for line data input

This reel can be configured and set-up using the following options.

**P0 Config Input :16,17**  
TANA SENSOR BRIGHT is easily configured simply by inputting the data of the line wound on the reel.

**P1 Line Input: 18-20**  
This option allows you to set useful functions when you know the length of the fishing line to be wound on the reel.

**P2 Backing line input : 21-23**  
This option allows you to set functions to insert a backing line. Note that it is necessary that you know the line length and that it is greater than 100 m.

**P3 Line re-input : 24,25**  
This option allows you to re-enter the line data, pulling out the line after it has been completely wound up onto the reel. Note that it is necessary that you know the line length and that it is greater than 100 m.

Thank you for purchasing a LEOBRITZ 200J-L. Please read this operation manual carefully and use the product safely and correctly to take full advantage of this electric reel with many convenient features for your on-board fishing. Please keep this operation manual carefully together with your reel for your future reference.

# Caution

This document contains important instructions for using your electric reel. Please be sure to read them thoroughly before use.

## About the signs

 This sign means "prohibited actions." Within the area or near this sign, specific prohibited actions are described.

 This sign means "actions that require caution." Within the area or near this sign, specific actions that require caution are described.

 This sign means "mandatory actions." Within the area of this sign, specific mandatory actions are described.

## WARNING

The following pertains to matters that could cause problems or serious, even life-threatening injuries should the instructions be ignored or incorrectly followed.

-Be careful not to catch your fingers between the reel and the level wind, which is used to wind line into the spool evenly. It may cause injury.

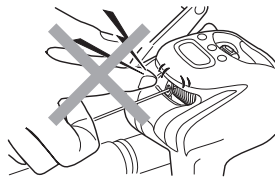

-When you turn on the clutch while feeding line (operated by the motor), it winds up the line. Be careful not to catch your fingers. It may cause injury.

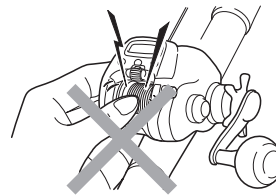

-Adults or parent's must supervise closely any use of this product by children. Use extreme caution to keep their fingers and hands away from moving parts or openings in the reel.

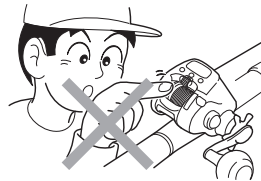

-When using batteries or the power supply of a boat, only apply the designated voltage. Other voltage may cause an abnormally high temperature in the electric reel, that could burn your hand or damage the microchip. Do not connect to house current or any AC (alternating current) power supply. The circuit may be short-circuited and result in smoke and fire.

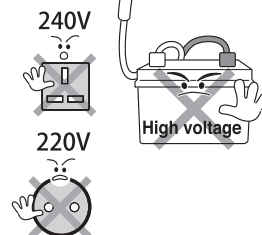

-Do not use and keep this product within the reach of children.



# Caution

## ⚠ WARNING

The following pertains to matters that could cause problems or serious, even life-threatening injuries should the instructions be ignored or incorrectly followed.

-The electric reel causes a small amount of electric waves that could cause malfunction of electronic medical devices such as hearing aids, cardiac pacemakers, etc. Those who have a cardiac pacemaker may feel palpitations and dizziness when using an electric reel, so confirm with the manufacturer of your medical device or the distributor regarding the influence of electric waves prior to use of this product.



**Cautious handling!**



-Do not fasten an electric reel with a harness onto your body. You may risk your life if pulled into the seawater by a big fish or in other situations.



**Do not use!**



## ⚠ CAUTION

The following pertains to matters that could cause problems or serious, even life-threatening injuries should the instructions be ignored or incorrectly followed.

-Do not touch moving parts while in operation. It may cause injuries.



**Hands off!**

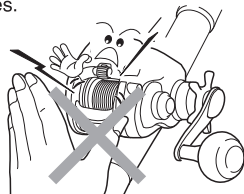

-Should water droplets get inside the liquid crystal, it could cause the microchip to malfunction and keep the motor turning. In such a case, stop using this product and have it repaired immediately.



**Do not use!**



-Should the motor fail to stop for some reason while fishing, use caution to prevent your fingers being caught in the reel. Disconnect the power supply immediately.

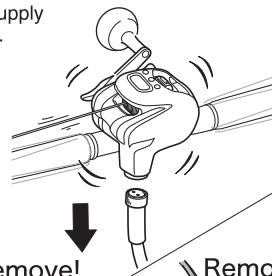

**Remove!**

**Remove!**



**Remove power supply!**



# Caution

## ! CAUTION

The following pertains to matters that could cause problems or serious, even life-threatening injuries should the instructions be ignored or incorrectly followed.

-Before adjusting drag tension, always turn off the automatic electric winding. You could cut your hand when pulling line to check tension.



Turn off!

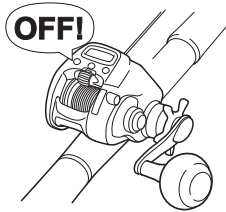

-When not tending this product, turn the power off (Power Lever back) and remove the power supply to prevent it starting accidentally and causing injuries.

Remove!

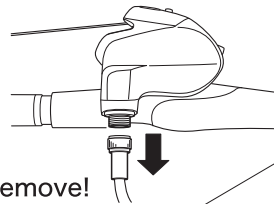

Remove!



Remove power supply!

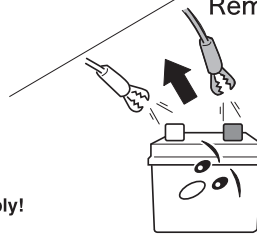

-Do not touch or grab the line when it is being released or wound rapidly. The line may cut your fingers.



Hands off!

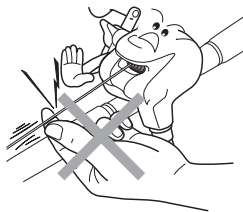

-When winding up line indoors, do so at high speed. If wound up at low speed and high tension, the motor may heat up abnormally and emit smoke. Power to wind up electronically may deteriorate.



Cautious handling!

*Hoo*

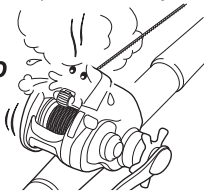

-A damaged cable may disrupt operation or short circuit and cause other problems depending upon the conditions of use. Be sure to follow the instructions stated in "Cable Handling Manual," "Cable Maintenance Manual," and "Other Instructions for Maintenance."

When not using the cable, disconnect the power supply.

It is recommended you replace the cable with a new one every other year to maintain full performance of the reel.



Handle it properly!



-Before reconnecting the power cable on the boat, thoroughly wipe away any moisture such as saltwater from the connecting parts with a dry cloth. If you connect it wet, it may short-circuit causing electric shock, smoke, or even fire.



Cautious handling!



# Caution

## ⚠ CAUTION

The following pertains to matters that could cause problems or serious, even life-threatening injuries should the instructions be ignored or incorrectly followed.

-When your hook is caught in the bottom, do not jerk the rod to free it. Pull the line with your hand and cut it if it fails to pull free. (Be sure to protect your hands with gloves or a towel.)  
If you use thick leader and cannot cut it with hands, talk to the captain for a safe treatment.



**Risk of injury!**



-In case you smell burning or you find other troubles, stop the motor and remove the power supply. It may cause heat or fire.

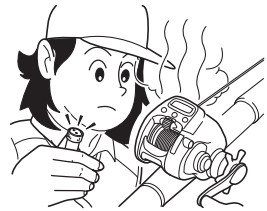

**Remove!**

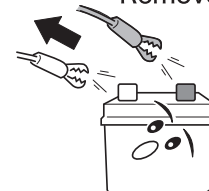

**Remove power supply!**

-Before connecting it to the power supply, be sure to loosen the drag well. If the IC breaks, and the motor does not stop, the terminal rig may be wound into the reel and the rod may break.



**Required handling!**

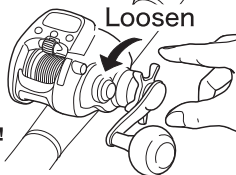

-Handle it cautiously as to not to stain your clothes with grease or oil from moving parts.



**Cautious handling!**

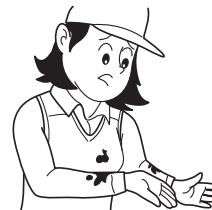

-Use the reel only for the purpose of fishing.



**Never use it for other purpose!**

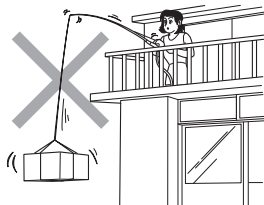

-Do not touch parts where the surface or top coatings (such as paint) are peeled off. It may cause injuries.



**Hands off!**



-Do not use wire line with your reel. It may cause corrosion or damage to the spool.

**Screech!**



**Do not use!**

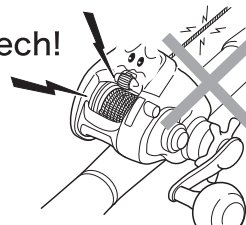

# Caution

## ⚠ CAUTION

The following pertains to matters that could cause problems or serious, even life-threatening injuries should the instructions be ignored or incorrectly followed.

-Do not wind up with excessive force when line is tangled with other angler's lines or snagged on the bottom. It may cause damage to your rod and other components.



**Handle with care!**



-Excessive shock, as from dropping, may cause malfunction with breakage or other damage to the internal electronic components such as cracks that allow water entry or short circuiting of circuit boards. Use care to avoid strong shocks and pressure (It may cause problems even though damage may not be visible.)



**Handle with care!**

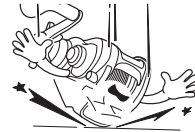

-Do not dismantle or modify the reel. It may deteriorate the performance of the reel or cause other problems.



**Do not modify!**



-Do not modify the cable. It may cause a short-circuit or other problems and could result in smoke or fire.



**Do not modify!**



-Reset the counter whenever it displays the wrong number, you have cut off line, disconnected the power supply or changed line tests. If you use the reel without resetting the counter, your terminal rig may be pulled into the reel and break the rod or other components. Forgetting to reset it with your terminal rig at the water surface may cause the same problem.



**Required operation!**



# Caution

## INSTRUCTIONS FOR HANDLING

This document contains important instructions regarding special attention that may be required when using an electric reel. Please be sure to read them thoroughly before use.

### ! ATTENTION

-Do not step on or place objects upon the reel. It may cause problems with the reel.

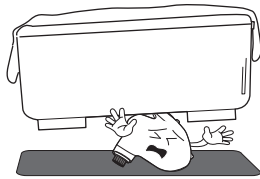

-Do not leave the reel near heating appliances. Resin may melt and deform or deteriorate causing problems.

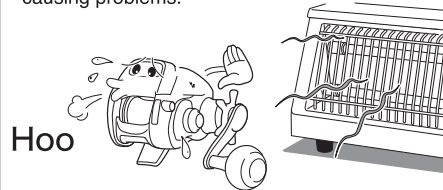

-Do not insert a stick or metallic object into the opening between the spool and the frame or other parts of the reel. It may cause problems with the reel.

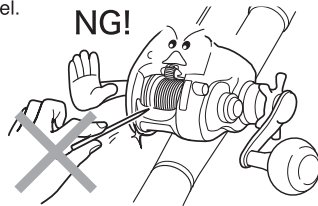

-When storing the reel for a long time, wipe down the moisture completely and preserve it in as well a ventilated place as possible without direct sunlight. Loosen the drag when storing it.

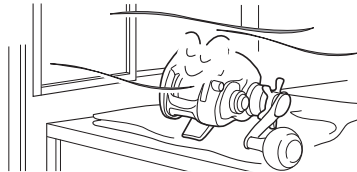

-Before removing the power supply, turn off the power (power lever back) as it could cause problems with the reel.

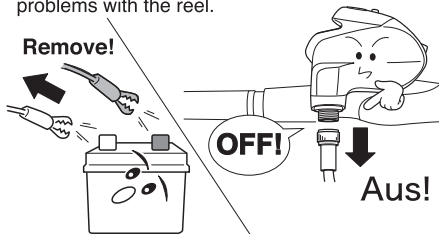

-When the reel is stored with the wet line with salt seawater, the spool may rust. Wash only the spinning part with tap water to rinse off seawater sufficiently, and then dry it in a well ventilated place without direct sunlight before storing it.



-Before going fishing, please check the reel for proper operation to ensure an enjoyable fishing trip.

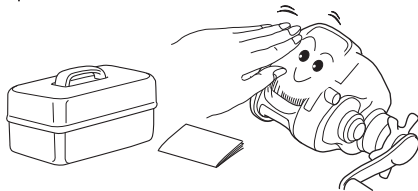

-Do not store a wet reel in a plastic bag or a fishing bag because it may cause rust or malfunction.

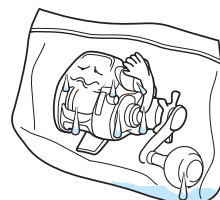



# Caution

## ⚠ ATTENTION

-Use neutral detergent (dish washing detergent) when washing the electric reel. Do not use chlorine, acidic, or alcohol type cleaners. It may deteriorate resin and cause problems with the reel.



-Be cautious not to let cloth or other objects become caught in the reel when winding. Be careful not to have the line slackened by backlash or other cause caught into the reel.

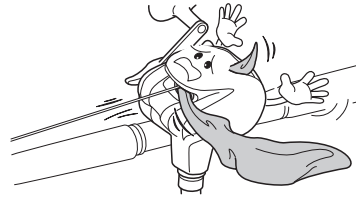

-Unplug the power supply and the cable when not in use.

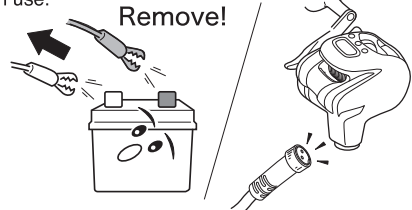

-Do not store the reel with tightly-wound, damp line. During storage, the line may dry up and shrink, resulting in damage to the spool. Do not wind nylon or fluorocarbon line onto a model designated exclusively for PE line (braided line).

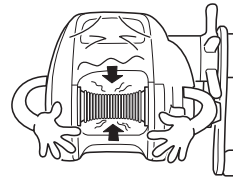

-Do not put a magnetic item such as magnet closer to the product. Otherwise, it malfunctions or causes failure.

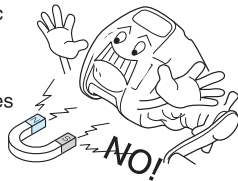

-When fixing the rod into a hole on the boat edge with the reel attached, verify that the reel does not touch the edge. When it touches, do not place it into the hole. The reel may be damaged.

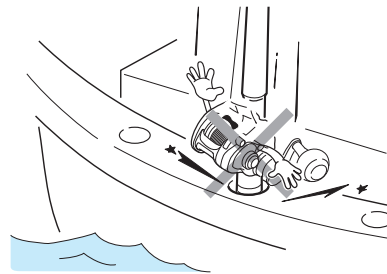

-When shrinking a telescopic rod, do not tap rod butt on the ground with the reel attached. The reel may be damaged.

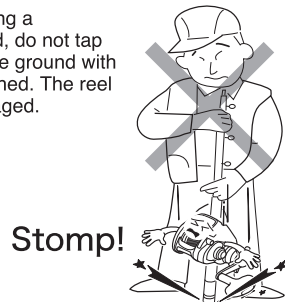

### ◆ About the counter display

The following conditions may make the display difficult to read.

1. Wearing polarized glasses.
2. Excessively cold or hot weather, mid-winter (display's surface temperature is below  $-10$  degrees centigrade) and mid-summer (display's surface temperature is above  $60$  degrees centigrade).
3. When light strikes the display from certain angles, the display's digits may have shadows. This does not affect its function.

# Power source

## How to connect the power source

1. Attach the cord clips to the battery.  
Red covered clip is the plus (+), and the black covered clip is the minus (-).
2. Insert the connector into the reel. After this, the display appears as below.  
By taking the appropriate steps, the indication will change as shown below and the data will be set.

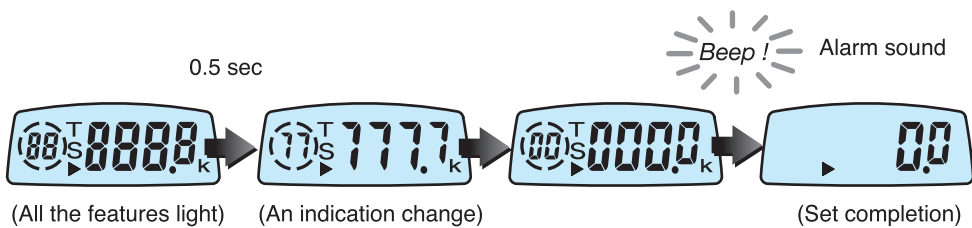
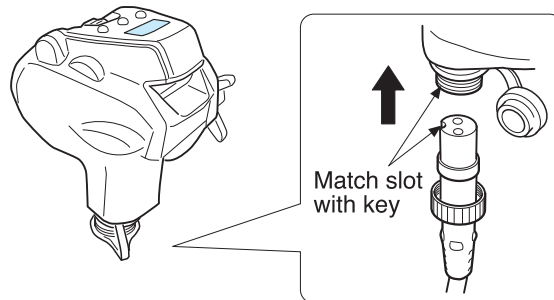
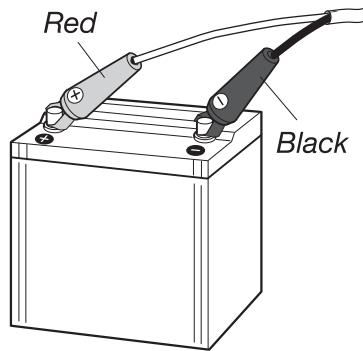

### Attention

When changing batteries, the display's back up memory stays active for about 15 minutes after the old battery is disconnected. Thus the above display startup sequence does not need to replay when the new battery is connected within the 15 minute time frame.

# Power source

## About the power source

This reel is designed to be compatible with direct current (DC) 12 Volt only. You may not use any power sources other than DC12V to power this reel (for example, AC100V from a household power supply and DC24V equipped on a boat).

The power source voltage on a boat tends to lose stability as it is largely influenced by a generator on board and wiring which may trigger the protective circuit causing sudden stop or intermittent operation of the reel. To maximize the reel performance, be sure to use the electric reel specific batteries.

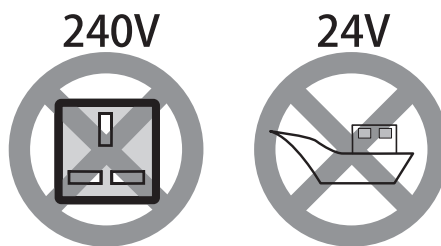

### Attention

*Make sure of the following before departure.*

- 1. Recharge the battery before your fishing trip. Over time, a battery can naturally discharge.*
- 2. Confirm the boat can provide the proper power source (i.e. voltage, connector shape etc).*
- 3. Corroded connections can prevent the flow of electric current. Remove any corrosion or dirt from the connectors.*

## Battery level indicator

While the reel is turned on (during windup or when windup stops), the **Lo** sign blinks if the power-supply voltage reaches DC 9.9V or lower.

With power on, digits of the inverse counter (counter in the lower area) will blink if voltage gets below DC 9 V.

If the display shows this when the motor is not running, then battery voltage is likely to be low. In this case, replace the battery with a recharged one.



# Maintenance

## About maintenance

This is a washable reel. Wash away salt residue and grit after fishing.

## Maintenance procedure

1. Wash the reel main body with a soft sponge or other tool to remove the stain.

Do not use soap or other detergents. Other soaps or solutions may damage the reel both externally and internally. The solution may damage the outside coating of the reel and may breakdown the grease inside of the reel creating an overflow of grease.

2. Rinse detergent and dirt away with running water, rinsing the spool very well to get rid of salt. Use warm water, under 30 degrees centigrade.

3. Dry the reel well.

\*Loosen the drag when stored.

\*Be sure to remove water from inside the handle knob, because water could build up there.

4. Feed oil.

(1) There is no feeding port. Remove the spool adjustment dial to feed the oil. If you feed the oil too much, the oil may leak. Feed the oil carefully.

\* Do not feed any oil other than CRBB oil spray. Otherwise, the performance of the reel cannot be brought out.

Get the dedicated spray from a fishing-tackle store.  
Product code: 199695

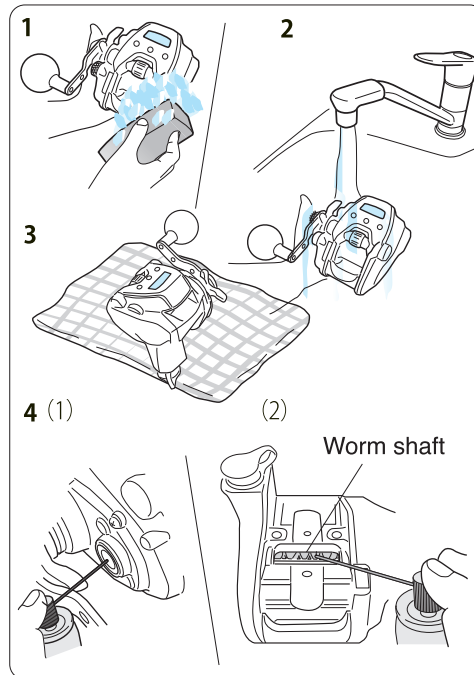

(2) Spray oil on the worm shaft.

\* Recommended grease: genuine reel guard grease  
(product code: 04980020)

## Attention

1. Do not wash with seawater or soak in water.
2. Do not use organic solvents such as benzene and thinner.
3. Do not use a steel brush or abrasive cleanser.
4. The fed oil may spring back and squirt. Do not peer down the worm shaft part.
5. Do not feed oil to water discharge hole.
6. Do not put magnetic force closer to the product main body.

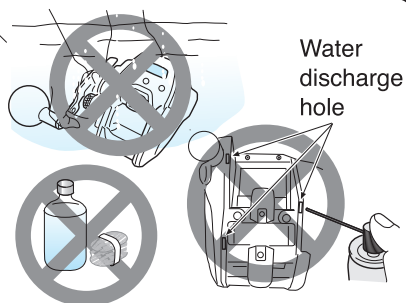

# Maintenance

## Handling and maintenance of the power cord

Follow the restrictions below to avoid troubles caused by disconnection of power cord and the like.

Be sure to use the specific power cord supplied with the reel unit.

\*Note that the unit is not compatible with any other power cord.

\*Do not modify the power cord. It may cause an unintended failure. Be sure to keep the power cord intact.

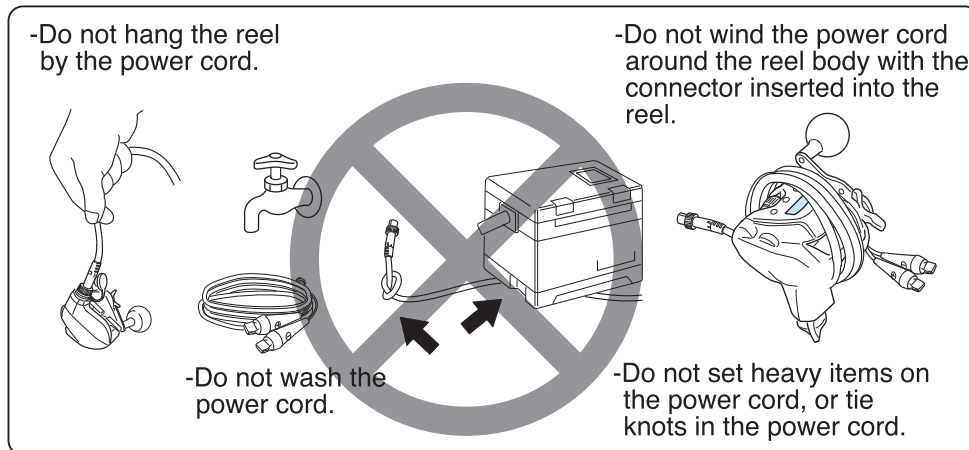

## Maintenance of the power cord

-Wipe the power cord with a wet cloth and dry it well.

-Pay special attention to drying the tips, with cover removed.

-Grease the connector after it is dried.

-Disconnect the power cord from the reel before storing.

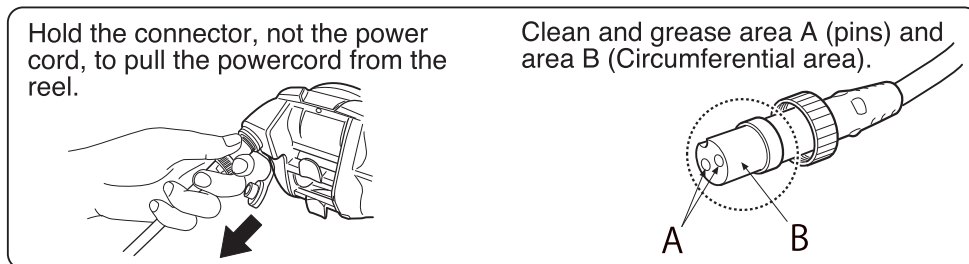

## Other maintenance points

-This reel is a precision instrument that employs electric circuitry and motor. Do not disassemble the reel by yourself.

-Cover the power connector on the reel with its protection cap.

-Old or worn cords can cause a bad connection and/or short circuit. Replace the cord every 2 years.

# Names and functions of each part

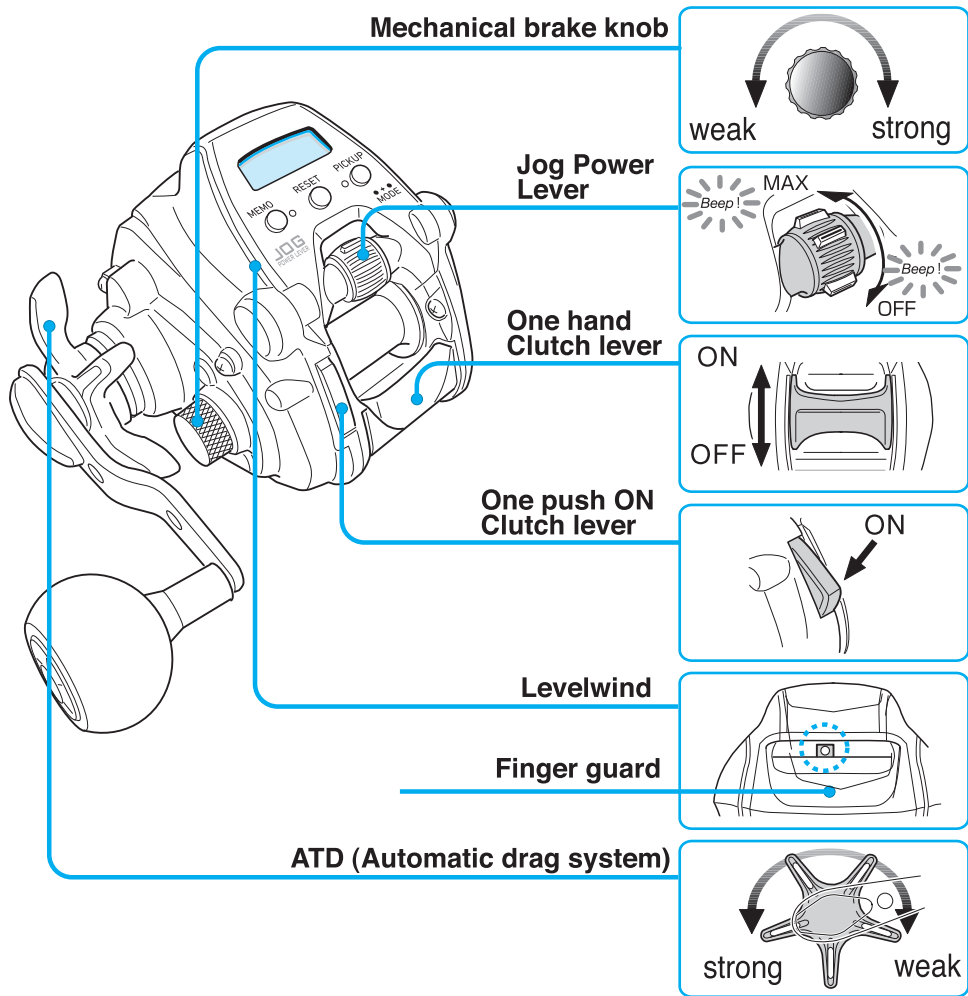

## Accessories

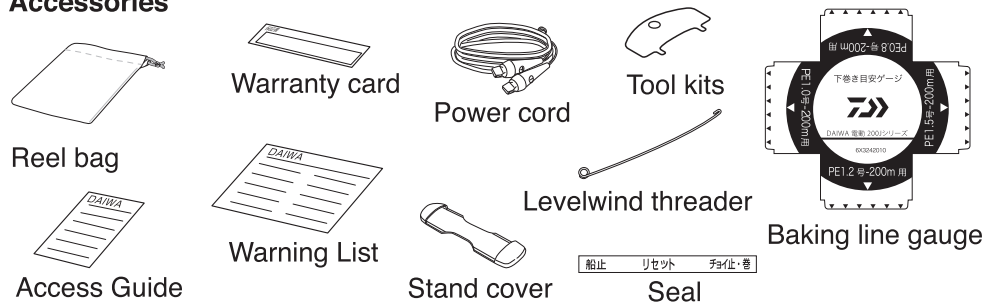

# Names and functions of each part

## Jog Power Lever

- You can freely adjust the winding power (speed) from OFF to MAX by using the lever.
- Turning the lever forward (toward MAX as shown in the figure left) will increase the power (speed) (increase the winding speed).
- Turning the lever back (toward OFF) will decrease the power (speed) (decrease the winding speed).
- Check the position of the lever before you start winding. If it is not at OFF position, turn it back to OFF position (an audible alarm will sound to tell you that the lever has backed to the OFF position). Then, push the lever forward to start winding.
- Note that the lever does not accept your lever manipulation near the pre-set auto stop point for safety reasons.
- The displayed value for setting by the lever may fluctuate due to winding load fluctuation but it is not abnormal event.

## TD (Automatic Drag System) \* With a drag click system

- This is designed to provide a mechanism whereby adjusting the star drag allows the spool to slip against a strong pull to avoid line breakage.
1. Set the reel on the rod and put the line through the rod guide before adjusting the drag.
  2. Adjust the tightness of the drag, with the clutch ON, manually pulling the line out from the reel. Normally, adjust the drag allowing the spool to slip before the line breakage (trace line).

## One-Push ON Clutch Lever

- The clutch turns to ON by pressing the lever when the clutch is OFF.
- You can turn the clutch to ON quickly with your hand holding the rod.

## Spool free adjustment knob

- This is a brake system to prevent backlash (curls due to a slack of line). Adjust the tightness depending on the conditions such as rolling of your boat and the rig weight.

## Levelwind

- The levelwind allows to ensure an even winding of the line on the spool that is passed through the guide.
- \*The line may be wound unevenly on the spool depending on the winding condition in some cases.

## One-Hand Clutch Lever

- You can disengage the clutch by slightly pressing down with your thumb.
- ◆While it is turned ON: Turn the handle to wind up the line.
- ◆While it is turned OFF: Spool is free. Turn the handle clockwise to turn ON the clutch.

## Accessories

- Power cord /Access Guide/Warning List /Seal /Tool kits /Reel bag /Warranty card / Baking line gauge.
- Line Threader  
It is used to put the line through the level wind. (The line threader is packaged in a plastic bag as one of the accessories together with the reel bag).
- Stand cover  
Use it to protect the reel and the rod and prevent rattling with respect to the reel seat.

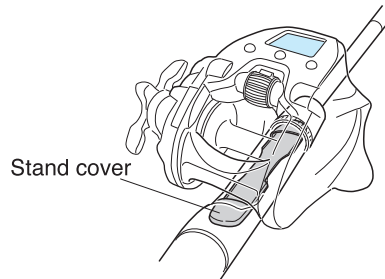

## ⚠ Attention

- \* If the stand cover is attached, the reel will not be attached depending on the rod.
- \* If the stand cover is attached to a type of rods with a rotary installation base, the stand cover may be broken.
- \* Excessive tightening of the reel seat may cause the stand cover to be deformed and contact with the spool, resulting in decrease in the spool free performance (lowering of the terminal rig).

## Names of the buttons and the display

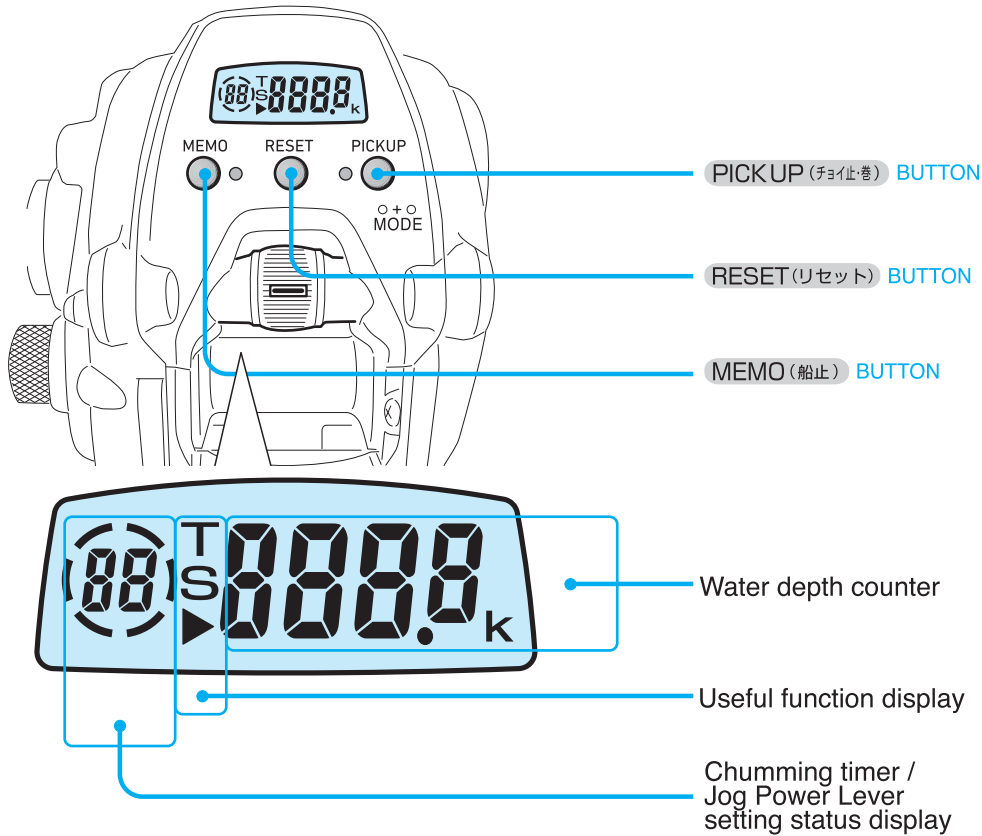

### ●RESET (リセット)

When you press the **RESET (リセット) BUTTON**, the water depth counter will show **0.0** m. And the chumming timer will be reset.

\*Be sure to press the **RESET (リセット) BUTTON** once always before you start fishing. The auto stop position is set based on the point where you pressed the button.  
( **S** (船止) will appear on the screen.)

The initial setting of auto stop is preset to **2.0** m. Refer to the page 28 "Water depth zero setting"

\*Do not press and hold the **RESET (リセット) BUTTON**, except for data correction of a broken line; it may cause an error in the counter.

### ●MEMO (船止)

When you press and hold the **MEMO (船止) BUTTON** for about 2 seconds, auto stop will be set. (refer to the page 29). When you press this button, chumming timer will start again.



# Names of the buttons and the display

## ●PICKUP (チョイ止・チョイ巻き)

In the mode setting screen, you can use this button to select Pickup or Pause mode.

### • Pickup

-You can wind up the line by the electric reel only while pressing the PICKUP (チョイ止巻) BUTTON. This mode is useful to remove a slack of the line or attract fish.

-The winding speed can be changed in the range between 0 and Hi in the submenu of this mode.

\*If the winding speed is set to 0, the line will not be wound up when you press the button.

\*This button will be disabled for safety when you press this button at the distance 3 meters or more from the auto stop point.

### • Pause

-While electrical winding up:

You can pause the electrical winding up only while pressing the PICKUP (チョイ止巻) BUTTON.

## ●MODE (モード)

Press and hold both MEMO (船止) BUTTON and PICKUP (チョイ止巻) BUTTON simultaneously for 2 seconds to go to the Menu screen where you can set various useful functions.

-Once you have set up your settings, you can also use the settings in the next fishing as they are.

-Use the Jog Power Lever to enter any values and turn ON/OFF the functions.

-After entering your desired values, press the MODE (モード) BUTTON. The setting will be completed when the next mode appears.

-Every time you press the MODE (モード) BUTTON, each screen will be "jogged".

-If keep pressing the MODE (モード) BUTTON, each screen will be fast forwarded to return to the "Water Depth" screen.

## ●Mode setting function display

-The screen to set useful functions is displayed.

-Indicators of the active functions which have been setup will be turned ON (blink),

**S** (auto stop at boat) is turned ON:  
If you press the RESET (リセット) BUTTON, it will be turned ON. (The boat will make Auto Stop at 5.0 m from the boat if you have not set the water surface zero setting).

**▶** (Pickup) is turned ON:  
You can wind up the line by the electric reel while you keep pressing the PICKUP (チョイ止巻) BUTTON.

**T** (Timer) is turned ON:  
Chumming timer will be active to wind up the line.

**Lo** Lo is blinking:  
This will be blinking when the battery voltage is lowered (No display appears if you press the MODE (モード) BUTTON).

## ●Water Depth Counter

-This displays the depth from the water surface.

## ●Chumming Timer

-This shows the time having elapsed every from dropping the rig (chumming timer), while the motor is stopped.

-Or, this shows the Jog Power Lever setting status (1 to Hi), while the Jog Power Lever is operated.

# Line data input (TANA sensor Bright section)

If you use our shelf sensor Bright or Nylon line, you can use the preset data input to set for your winding. The preset data input allows you to simply input data only by selecting your line from the selection as shown in the next page such as line kind, thickness, and winding length. (The following example explains how to insert a Self Sensor Bright-#3-200m fishing line.)

**Pay attention to burn injury!**

When you input the fishing line, the motor gets overheated and the frame gets very hot. Do not touch the frame directly with your hand. Apply wet towel etc. to the frame to input the fishing line.

1. Pass the line for lower winding through level wind and tie it with spool, and the distribute the power.
  - \* You can lace the line easily by using the included threader pin.
  - \* To prevent the slip of line on spool surface, be sure to tie the line with the line stop pin.
  - \* Tighten the drag line.
2. Return the Jog Power Lever to OFF.
3. Turn ON the reel and turn the Jog Power Lever to the MAX position. Then, wind the main line to its end.
  - \*Please refer to the page 8 "How to connect the power supply" for the details of the connection procedure.
  - \*Wind the main line at about 1 kg tension.

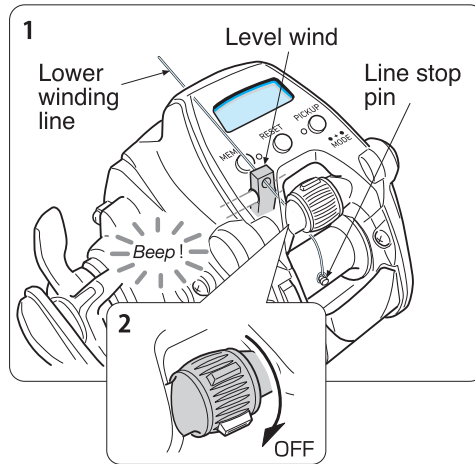

**Attention**

- If a line contacts finger guard or frame, the reel may be damaged. Take care not to contact the line with such a part.  
 - If you wind the line at low speed and with high tension in doors over time (\*1), the motor generates heat abnormally and it leads to failure. Carry out the input by set the power lever to max position. At the actual fishing, the motor is cooled down by salt water etc., so there is no problem.  
 (\*1) If the line is wound for 10 minutes continuously, the motor overheat prevention function operates. The motor stops and the screen display blinks and all operations are disabled for 5 minutes. If the number on SCATTERING timer is counted down as 4, 3, 2, 1, 0 (minutes) and the alarm sounds "Beep", the input in the status before stop is enabled.

4. When **-0.0** is displayed, press **MEMO (船止) BUTTON** and **PICKUP (フヨ止巻) BUTTON** at the same time for 6 seconds continuously.

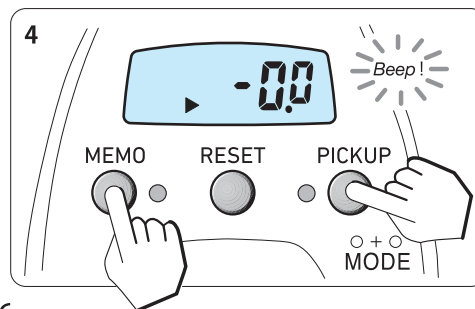

# Line data input (TANA sensor Bright section)

\*Keep pressing the button, though the pickup screen will appear in about 2 seconds,

5. The screen for the initial setting for PE#3-200m will appear.

\* If you keep pressing the buttons.

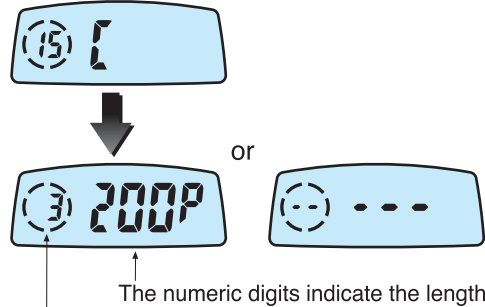

6. Select any of the combinations of the line thickness and the winding length.

\*Turn the lever forward to increase the numeric value.

\*Turn the lever backward to decrease the numeric value.

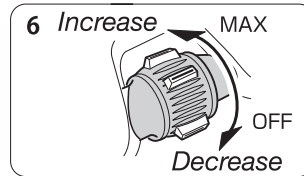

The following table shows the list of the preset data.

\*In this figure, the preset data for PE#3-200m line is set for.

### List of the preset data options

PE (numeric digits followed by P) (m)		Nylon (numeric digits followed by L) (m)	
#1.5	450	#3	250
#2	300	#4	170
#3	200	#5	140
#4	170		

7. When you finish your selection of the numeric value by Jog Power Lever, press P PICKUP (予約/止巻) BUTTON . Then, your selection is completed.

\*Then, alarm beeps and 0.0 will be blinking. When the blinking stops, the setting is completed.

### Use

\* LEOBRITZ200J-L has the preset data of "Tana Sensor Bright PE#3-200m long" in its memory. No data input is required when you wind up Tana Sensor Bright PE#3-200m.

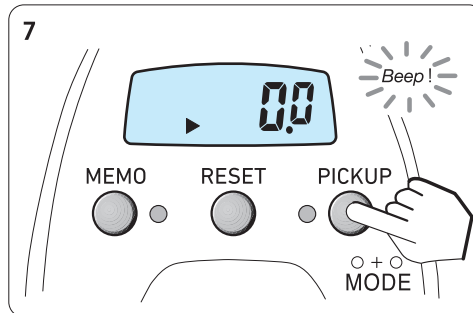

# Line data input (When line length is known)

If you know the length of the line to be wound on the reel, take the following steps for more convenience.  
(Here, a line PE#3-200m long is used as an example to show you how to input and set this sub-parameter by winding the line)

**Pay attention to burn injury!**

*When you input the fishing line, the motor gets overheated and the frame gets very hot. Do not touch the frame directly with your hand. Apply wet towel etc. to the frame to input the fishing line.*

1. Pass the line for lower winding through level wind and tie it with spool, and the distribute the power.
  - \* You can lace the line easily by using the included threader pin.
  - \* To prevent the slip of line on spool surface, be sure to tie the line with the line stop pin.
  - \* Tighten the drag line.

2. Return the Jog Power Lever to OFF.
3. Turn on the reel.

4. When **0.0** is displayed, press **MEMO (船止) BUTTON** and **PICKUP (フヨイ止巻) BUTTON** at the same time for 6 seconds continuously.

\*Keep pressing the button, though the "Pickup screen" will appear in about 2 seconds.

5. The Initial setting screen for PE#3-200m will appear.

\* If you keep pressing the buttons.

6. Press **PICKUP (フヨイ止巻) BUTTON** once to go to the Line-length Input screen.

(**P1** starts blinking)

7. Adjust the tension of the line. Then, turn the Jog Power Lever to the MAX position. Subsequently, wind the main line.

\*Adjust the tension so that the numeric figure on the left bottom of the panel becomes 3 or 4.

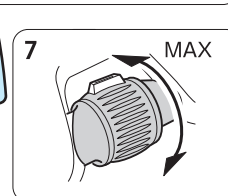
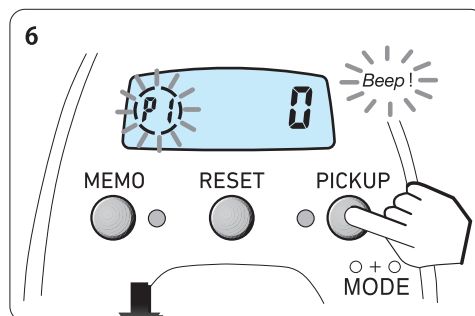
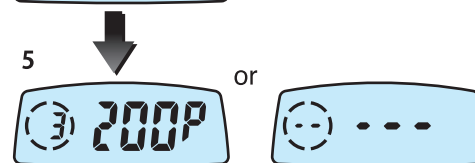
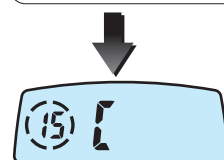
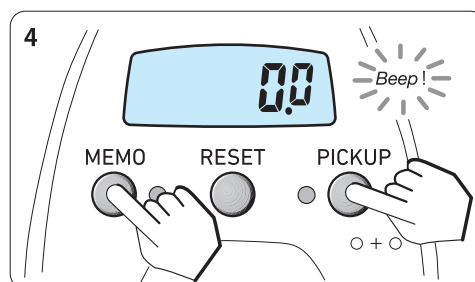

# Line data input (When line length is known)

## Attention

- If a line contacts finger guard or frame, the reel may be damaged. Take care not to contact the line with such a part.
- If you wind the line at low speed and with high tension in doors over time (\*1), the motor generates heat abnormally and it leads to failure. Carry out the input by set the power lever to max position. At the actual fishing, the motor is cooled down by salt water etc., so there is no problem.
- (\*1) If the line is wound for 10 minutes continuously, the motor overheat prevention function operates. The motor stops and the screen display blinks and all operations are disabled for 5 minutes. If the number on SCATTERING timer is counted down as 4, 3, 2, 1, 0 (minutes) and the alarm sounds "Beep", the input in the status before stop is enabled.

8. Pull the lever back to the OFF position, after winding.

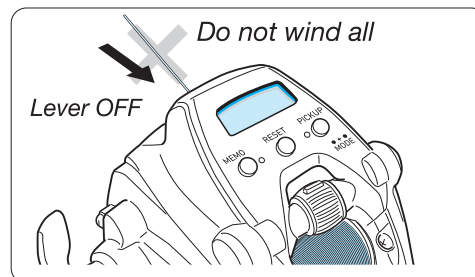
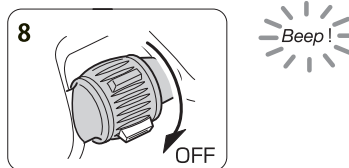

## Attention

- Do not spool up the line completely. Set the jog power lever to OFF position on front side and wind it with a handle. If it is spooled up, it causes an error of counter.
- In this input method, fine line less than PE No.0.8 cannot be input.
- In case of PE No. 0.8, if you wind it up to almost external diameter of spool, PE line may enter between spool and frame. It is recommended to wind it up to approximately 1mm smaller than external diameter of spool.

9. Press **RESET (リセット) BUTTON** for 2 seconds, until the display shows **200**. ( **200** is the default setting)

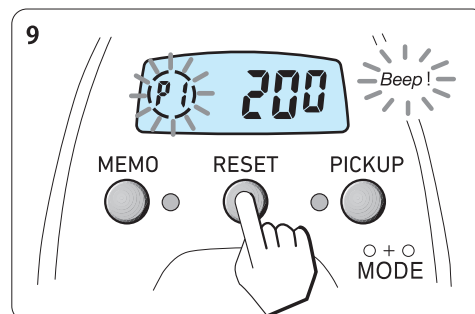

# Line data input (When line length is known)

10. Enter the line length with the Jog Power lever.  
 (in the figure on the right, line length is 200 m).  
 (The value can be set for every 10m.)

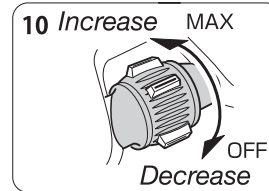

11. Press **RESET (リセット) BUTTON** for 2 seconds and a beep will be heard. The display should return to **0.0** blinks, completing the setting procedure.

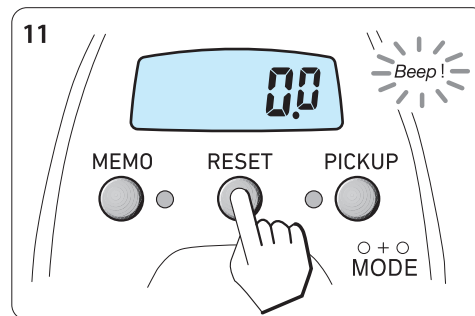

\* If **Err** is displayed, press **PICKUP (リコイル巻) BUTTON** and carry out the input from beginning or input of pullout (pages 24, 25).

# Line data input (Backing line input)

However, 100m or more fishing line you know the length is required.

**Pay attention to burn injury!**

When you input the fishing line, the motor gets overheated and the frame gets very hot. Do not touch the frame directly with your hand. Apply wet towel etc. to the frame to input the fishing line.

1. Pass the line for lower winding through level wind and tie it with spool, and the distribute the power.
  - \* You can lace the line easily by using the included threader pin.
  - \* To prevent the slip of line on spool surface, be sure to tie the line with the line stop pin.
  - \* Tighten the drag line.
2. Wind the line for lower winding.
  - \* If the Jog Power Lever does not exist at OFF position, return it to OFF position (front side) once, and then output it.
  - \* Adjust the amount of lower wound line using the included lower winding gauge.

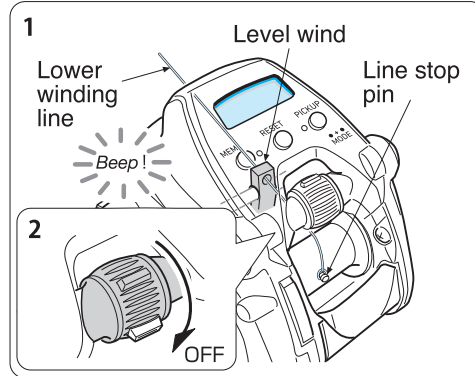

3. Tie the upper line securely.

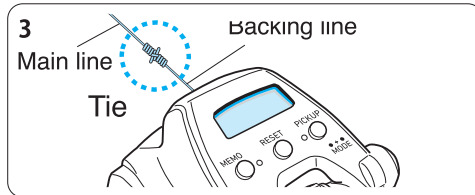

4. When 0.0 is displayed, press MEMO (船止) BUTTON and PICKUP (チャイ止巻) BUTTON at the same time for 6 seconds continuously.
  - \* Approximately 2 seconds later, the screen shifts to jog winding screen.
  - \* If you keep pressing the buttons. Next, if you press PICKUP (チャイ止巻) BUTTON, P1 blinks.

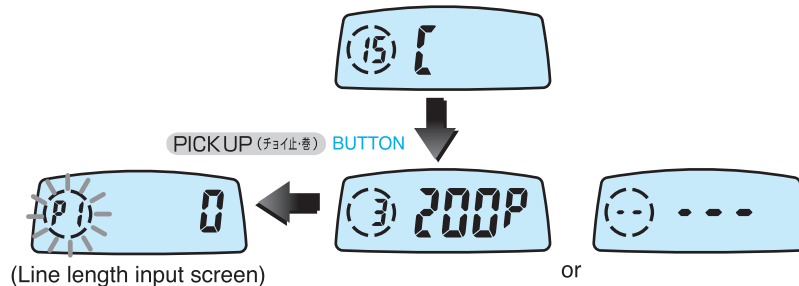
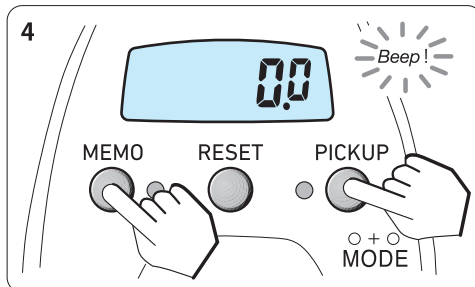

# Line data input (Backing line input)

5. If the line length input screen is displayed, press PICKUP (釣り止巻) BUTTON again to display the lower winding input screen. P2 blinks.

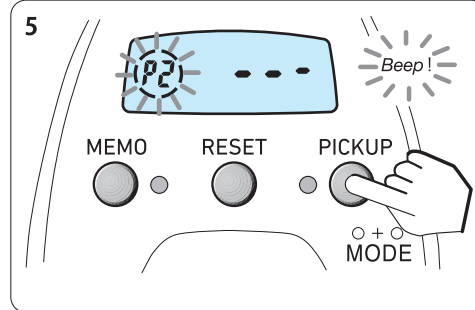

6. Tension the line and wind the fishing line until the remaining length becomes 100m paying attention to the line color.

If the winding of line is started, the frame around P2 rotates.

If you tilt the jog power lever, P2 changes to the tension display. Adjust the tension to 3 to 4.

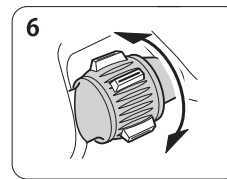

## Attention

- If a line contacts finger guard or frame, the reel may be damaged. Take care not to contact the line with such a part.
  - If you wind the line at low speed and with high tension in doors over time (\*1), the motor generates heat abnormally and it leads to failure. Carry out the input by set the power lever to max position. At the actual fishing, the motor is cooled down by salt water etc., so there is no problem.
- (\*1) If the line is wound for 10 minutes continuously, the motor overheat prevention function operates. The motor stops and the screen display blinks and all operations are disabled for 5 minutes. If the number on SCATTERING timer is counted down as 4, 3, 2, 1, 0 (minutes) and the alarm sounds "Beep", the input in the status before stop is enabled.

7. Press RESET (リセット) BUTTON for 2 seconds or more. P2 blinks and the lower counter indicates 50.

The value of upper counter increases by winding the line.

8. Tension the line and wind 50m of fishing line paying attention to the line color.

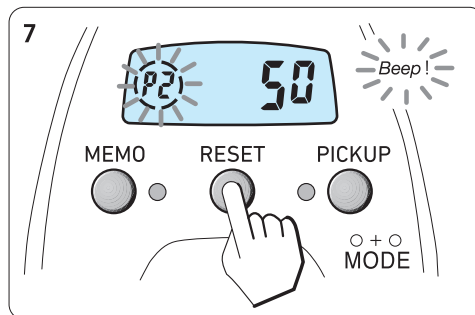



## Line data input (Backing line input)

9. Press **RESET (リセット) BUTTON** for 2 seconds or more.

**P2** blinks and the counter displays **100**.

10. Tension the line and wind the remaining 50m of fishing line paying attention to the line color.

11. Press **RESET (リセット) BUTTON** for 2 seconds or more. If the blinking of **0.0** display finishes, the input is completed.

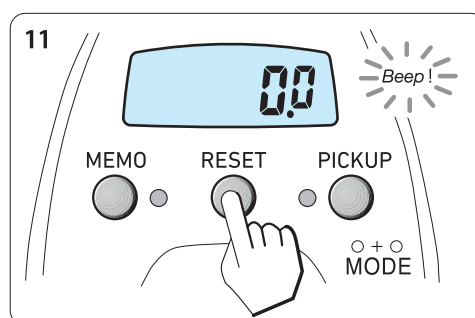
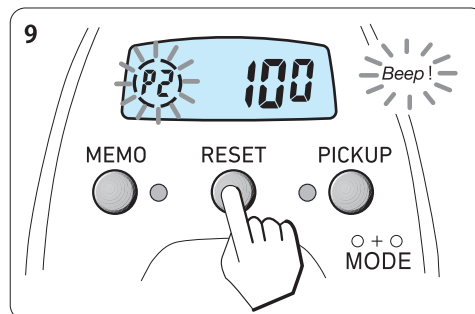

### Attention

- Do not spool up the line completely. Set the jog power lever to OFF position on front side and wind it with a handle. If it is spooled up, it causes an error of counter.
- In this input method, fine line less than PE No.0.8 cannot be input.
- In case of PE No. 0.8, if you wind it up to almost external diameter of spool, PE line may enter between spool and frame. It is recommended to wind it up to approximately 1mm smaller than external diameter of spool.

\* If **Err** is displayed, press **PICKUP (リヨ止巻) BUTTON** and carry out the input from beginning or input of pullout (pages 24, 25).

# Line data input (Line re-input)

This option allows you to re-enter the line data, pulling out the line after it has been completely wound up onto the reel.  
Note that it is necessary that you know the line length and that it is greater than 100 m.

1. Connect the battery to the reel.
2. Press **MEMO (船止) BUTTON** and **PICKUP (チャイ止巻) BUTTON** at the same time for 6 seconds continuously.  
\*Approximately 2 seconds later, the screen shifts to jog winding screen.  
\*If you keep pressing the buttons.

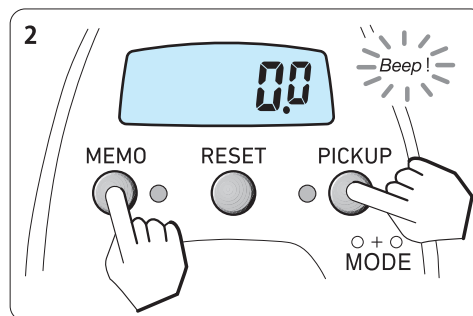

3. Press the **PICKUP (チャイ止巻) BUTTON** three times to display the pull-out input screen.  
\* **P3** blinks and **50** is displayed on the counter below.

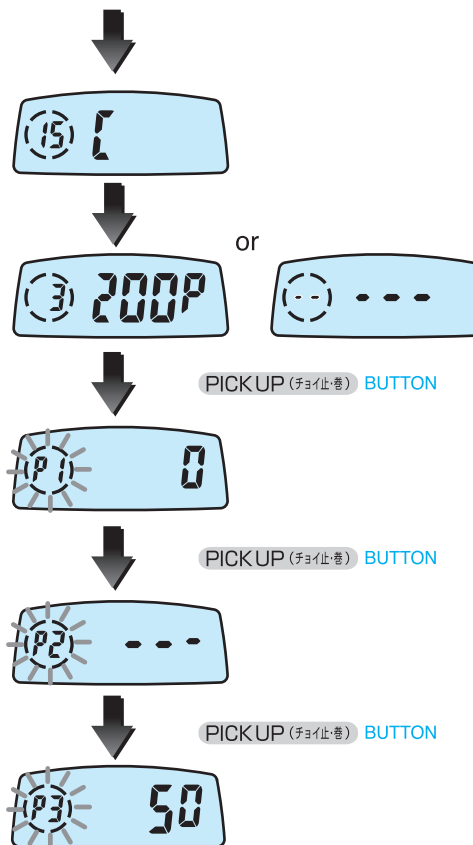

## Line data input (Line re-input)

4. Paying attention to the line's color coding, pull 50m of line off of the spool.

5. Press the **RESET (リセット) BUTTON** for 2 seconds. This will show the digits **100** in the lower area of the counter.

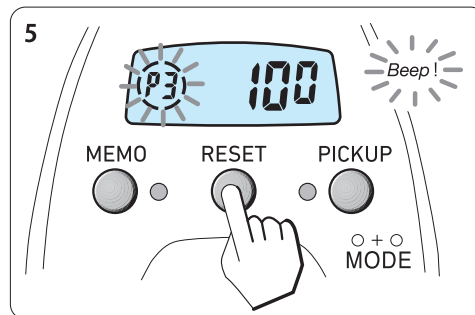

6. Pull an additional 50m of line from the spool.

7. Press the **RESET (リセット) BUTTON** for 2 seconds to show **100.0**.

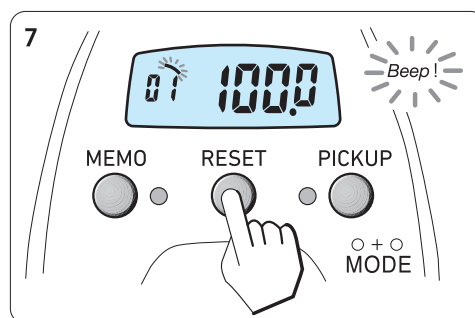

8. Wind up the 100m of line you pulled from the reel. This completes the procedure.

### Attention

- Do not spool up the line completely. Set the jog power lever to OFF position on front side and wind it with a handle. If it is spooled up, it causes an error of counter.
- In this input method, fine line less than PE No.0.8 cannot be input.
- In case of PE No. 0.8, if you wind it up to almost external diameter of spool, PE line may enter between spool and frame. It is recommended to wind it up to approximately 1mm smaller than external diameter of spool.

\* Should **Err** appear on the display, then use the **PICKUP (リセット)** **BUTTON** to re-enter the data.

# Functional setting [1. Mode setting display]

## How to set the many functions available

· There are many useful functions in the mode.  
 · On the settings screen, select the value and turn on/off the function by operating the Jog Power Lever, and then press the PICKUP (チョイ止巻) BUTTON to complete the settings as the next screen is displayed.  
 \*The functions set in this process are saved until the next use.  
 (In case the power is turned off immediately after the mode setting, it may not be saved properly.)

1. Press MEMO (船止) BUTTON and PICKUP (チョイ止巻) BUTTON at the same time for 2 seconds continuously.

\*To prevent erroneous operations, the switches are to be pressed down for two seconds. (The display turns to PICKUP.)

2. Press the PICKUP (チョイ止巻) BUTTON to choose a display.

Each press of the PICKUP (チョイ止巻) BUTTON changes the display to the next function.

\*Holding the PICKUP (チョイ止巻) BUTTON down, rapidly scrolls through the displays, quickly getting you back to the depth display.

\*Although the configurations have been changed on the mode screen, you will be able to retain the default setting by pressing the RESET (リセット) BUTTON from any screen.

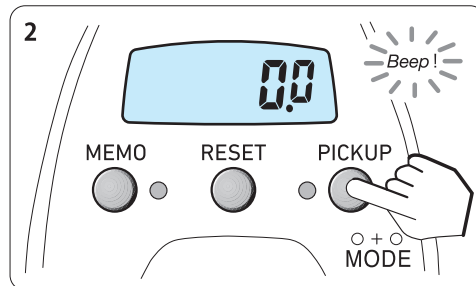
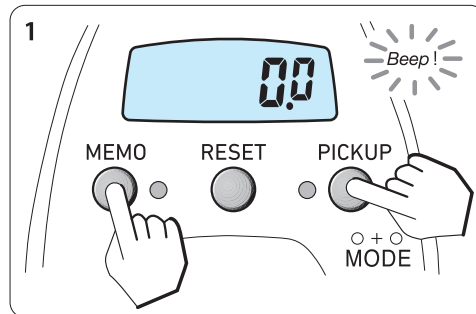

MEMO (船止) BUTTON and PICKUP (チョイ止巻) BUTTON simultaneously for 2 seconds.

PICKUP (チョイ止巻) BUTTON

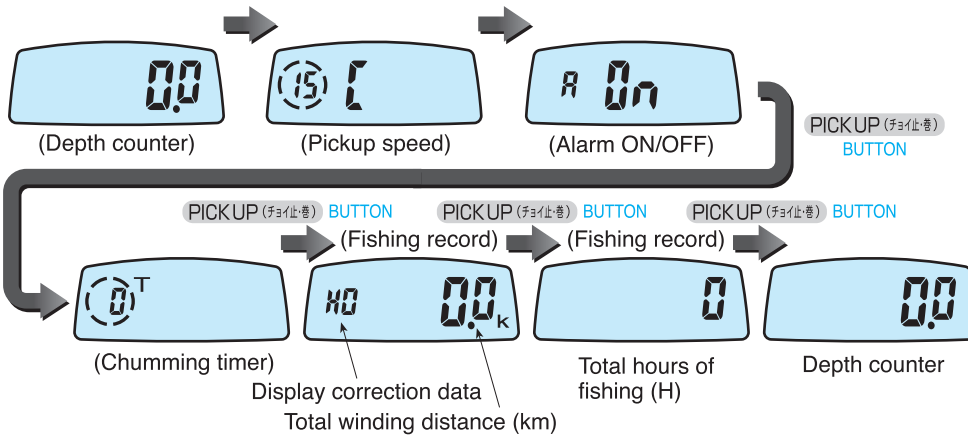

## Functional setting [1. Mode setting display]

3. Select the values and turn on/off the different functions with the JOG Power Lever.

- Turn the Jog Power Lever to MAX position to rapidly scroll up the numeric figures, or turn it to OFF position to rapidly scroll down them.
- Place it at any position between MAX and OFF to scroll the numeric figures in jog mode.
- Operating the Jog Power Lever allows to display "ON" and "OFF" alternatively.

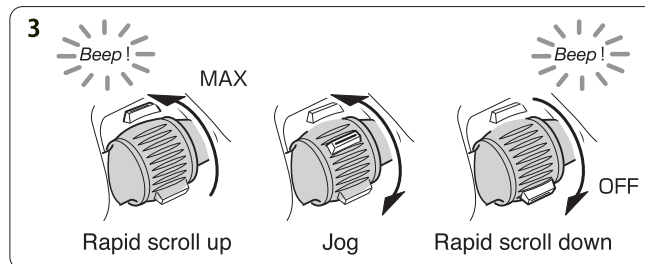

4. Press the **PICKUP (チョイ止巻) BUTTON** to complete the settings as the next screen is displayed.

- Depress and hold the **PICKUP (チョイ止巻) BUTTON** to rapidly scroll back to the depth counter screen.
- Return to the water-depth screen before starting fishing.
- Pressing the **RESET (リセット) BUTTON** on the settings screen allows you to retain the default settings. (It does not apply to fishing history.)

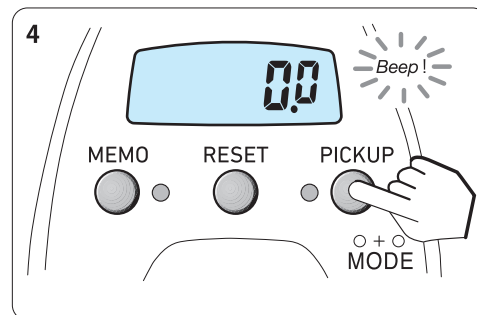

### Attention

- This reel is not equipped with the traditional electrical line feed function. When the rig is falling, operating the JOG Power Lever does not assist in feeding the line and may lead to trouble by overheating the motor, so never do this.
- When the rig is falling, operating the Jog Power Lever to engage the clutch while the motor is rotating may cause clutch failure. Make sure to engage the clutch when the motor is not moving.

## Functional setting [2. Before you begin fishing]

### Surface depth setting

This must be performed before starting fishing.

1. Connect the reel to the battery, put the line through all the guides, and prepare your terminal rig.

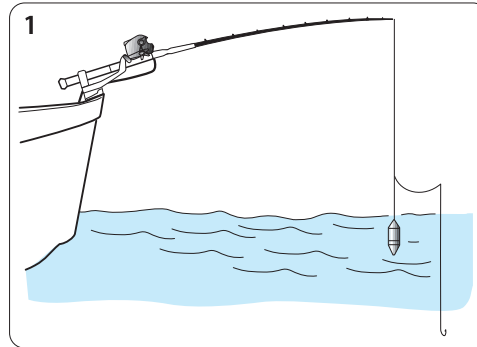

2. Lower the terminal rig to the water surface and press the **RESET (リセット) BUTTON**.

The display resets to **0.0** and the indicator lamp **S** (auto stop) will turn on. Then the setup has been completed.

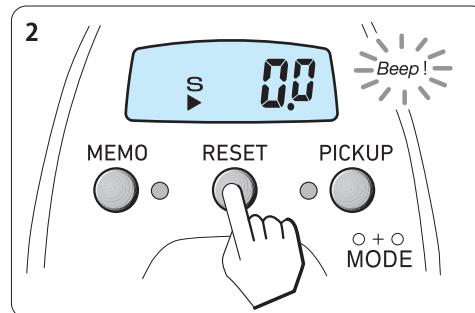

### Attention

-When new line is wound up, or when line has been pulled under heavy tension, line stretch may cause a gap in the auto stop point at the boat side. Simply reset the surface setting to set it to zero.

### If the main line is broken

-Should your line break, revise data as follows.

Revise the data of the broken line. Wind the line to the rod tip while the reel is powered on. Then, press the **RESET (リセット) BUTTON** for 2 seconds or more. When the display shows **0.0**, then your re-adjustment is completed.

\*The line data will be overwritten (revised) by the procedure described above.

\*Do not press and hold the **RESET (リセット) BUTTON**, except for data correction of a broken line; it may cause an error in the counter.

## Functional setting [3. Auto stop function]

### Auto stop setting

The Auto stop depth may be set to meet your own specific needs.

-You can set the auto stop point by setting the adjustable depth within the range 1 to 5 m from the point where you press **RESET (リセット) BUTTON** (in 10 cm increments).

Especially in case of chumming, it is recommended to set the adjustable auto stop point so that a chumming bait sinker comes to your hand side when you raise your rod tip, for more convenient checking and changing of baits and sinkers.

Note that it is designed not to allow you to set the auto stop point to any value below 1 m for safety reasons.

-In the case when you feel the auto stop point comes down due to line stretch, simply reset the counter to zero at the water surface.

-Note that the Jog Power Lever may not be allowed to manipulate around the auto stop point for safety reasons.

1. Connect the reel to the battery, and press the **RESET (リセット) BUTTON** with your terminal rig at the surface.  
(Surface setting)

The display shows **0.0**.

2. Raise the rod and adjust the line length from the rod tip so you can reach the rig easily.  
In the figure, its length is 1.5 m.

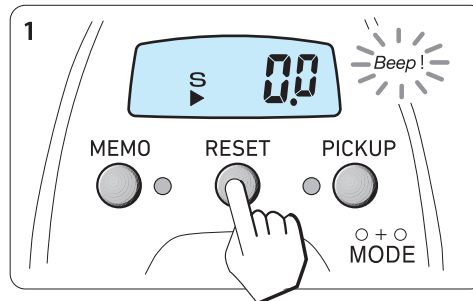

### Use

Checking and changing sinkers, baits etc.

3. After adjusting length, press the **MEMO (船止) BUTTON** for 2 seconds.

When **S** blinks, this procedure is completed.

\*Boat Edge Auto Stop is set at 2.0m by default.

(Unless the **RESET (リセット) BUTTON** is pressed, it stops at 5.0m.)

The **S** lamp will blink when the setup has been completed.

4. When checking or changing a bait, simply wait until the reel automatically stops winding and raise the rod tip.

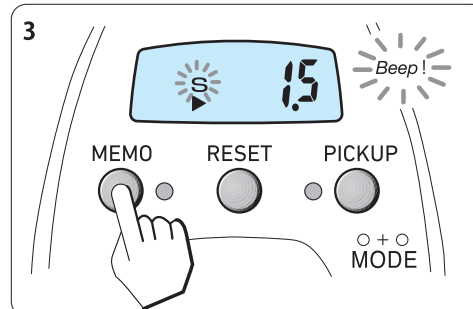
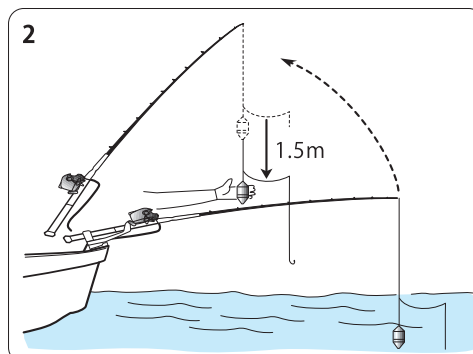

## Functional setting [4. Pickup speed setting]

### Pickup

This is very useful. You can wind the line by the electric reel only while pressing the PICKUP (チヨイ止巻) BUTTON. The pickup speed is set to 15 by default. You can change it in the Mode screen. (The setting can range from 1 to Hi.)

### Pickup speed setting

1. Press and hold both MEMO (船止) BUTTON and PICKUP (チヨイ止巻) BUTTON simultaneously for 2 seconds to go to the Menu screen.

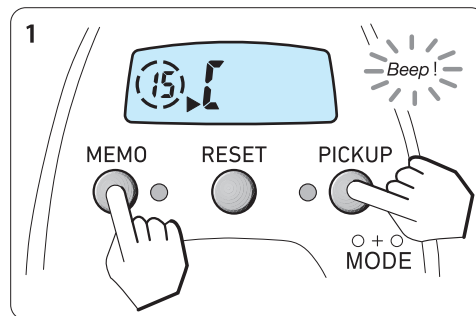

2. Set speed with the Jog power lever. The setting value is 1 to Hi.

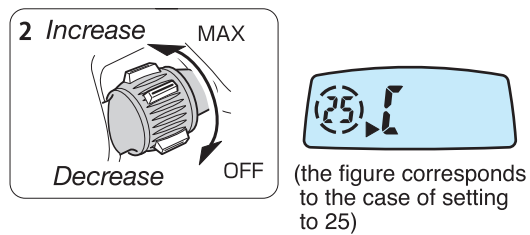

3. Press the PICKUP (チヨイ止巻) BUTTON five times and return to the "water-depth" screen to complete the settings.

▶ (チヨイ巻) will be displayed on the screen.

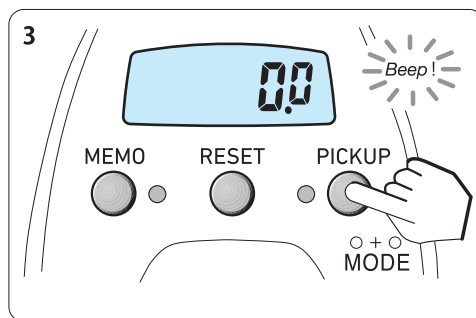

### Attention

- At any positions beyond the boat edge stop position + 3m, pressing the switch does not stop the reel for safety reasons.



## Functional setting [5. Pause setting]

### Pause

This is very useful. You can pause the electrical winding up only while pressing the PICKUP (チョイ止巻) BUTTON . When you release the button, the reel restarts winding up at the speed specified by the Jog Power Lever.

### Pause setting

1. Press down the MEMO (船止) BUTTON and the PICKUP (チョイ止巻) BUTTON simultaneously for 2 seconds.  
The display turns to PICKUP.

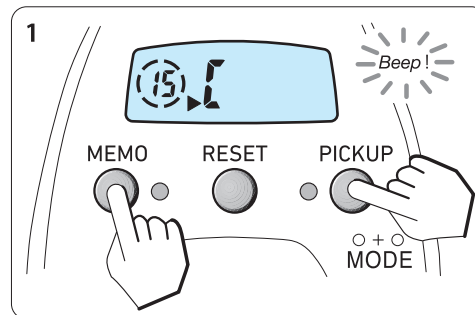

2. Operate the JOG Power Lever to set it to zero.

Using the  
JOG Power Lever



3. Press PICKUP (チョイ止巻) BUTTON to return to the Water Depth screen. Now, the setting is completed.

▶ (チョイ巻) turns off.

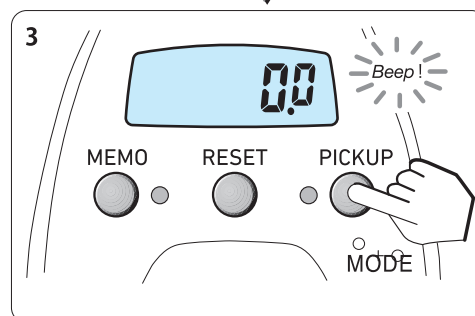

### Attention

- Although it is brought to a halt by pressing the PICKUP (チョイ止巻) BUTTON , moving the JOG Power Lever by  $\pm 3$  from its original position will stop winding for safety reasons.

## Functional setting [6. Chumming Timer]

### Chumming Timer

The timer display indicates the exact time of a rig being launched into the water. It is very convenient to maintain the pace of jigging.

-The display shows the time having elapsed since lowering of the rig started. You can roughly estimate the timing to chum or collect the rig.

-If you have not pressed the **MEMO (船止) BUTTON**, the chumming timer automatically starts when the depth counter determined the depth 7.0 m.

\*It is indicated in minutes if the remaining time is not less than 1 minute.

\*The timer function may not be reset.

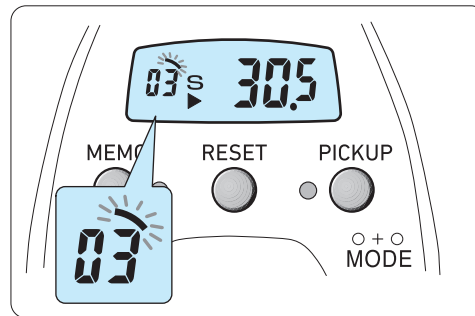

### Attention

If you press the **MEMO (船止) BUTTON** while chumming is in process, the timer indication will start from **0.0**.

·The chumming timer display turns off when the line is wound up to the boat edge stop position.



\* Each section of the outer circle measures 10 seconds, blinking in order.

# Functional setting [7. Chumming Timer winding]

## Chumming Timer Winding

Professional fishing techniques of checking and changing of baits and sinkers for all levels including beginners! Once you have set the waiting time simply, the reel automatically starts winding up. You can enjoy fishing more effectively and easily.

- If you have set the waiting time for a single chumming to 5 minutes, the reel will automatically start winding up at a high speed to allow you to check and change baits and sinkers after the timer started and the preset 5 minutes have passed.
  - When the chumming timer winding has been set, **T** (timer) will be blinking in the display. When you desire to reset it, set it to **0** (OFF). Then, **T** (timer) will be turned off.
  - The preset time can be checked by pressing the **MEMO (船止) BUTTON**.
  - You can set the chumming timer for winding at any time except while the electrical winding up is active.
- \*When beginning winding with the chumming timer, press the **MEMO (船止) BUTTON**.

1. Press down the **MEMO (船止) BUTTON** and the **PICKUP (チョイ止巻) BUTTON** simultaneously for 2 seconds to change to the mode screen and then to the PICKUP settings screen.

\*Refer to "How to Use the Mode Screen" on pages 28 and 29.

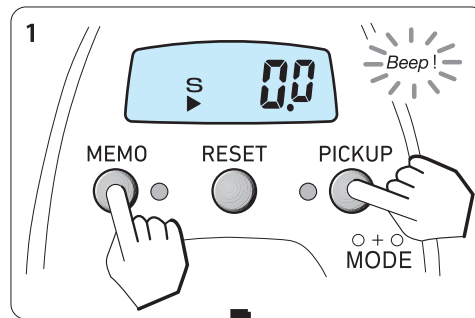

2. Press the **PICKUP (チョイ止巻) BUTTON** twice to display the timer settings screen.

**T** will be displayed.

- An alarm goes off before winding with the chumming timer begins.
- It is turned off by default.

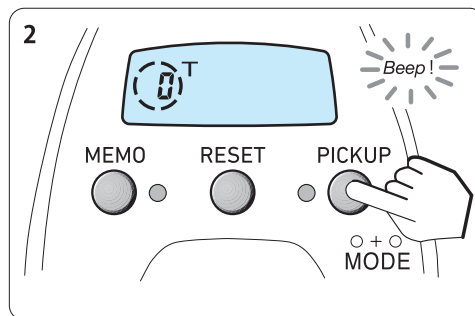

## Functional setting [7. Chumming Timer winding]

3. Select the waiting time (in minute) for checking and changing of baits and sinkers with the Jog Power Lever.

Turn the Jog Power Lever upward to increase the value. Or, turn it downward to decrease the value.  
(In the figure, the waiting time is set to 5 minutes)

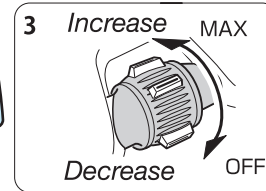
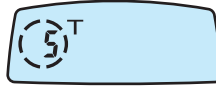

4. Press **PICKUP (釣り止巻) BUTTON**. If the screen returns to the Water Depth screen, then the setting is completed.

The indicator  (Timer) will light up on the screen.

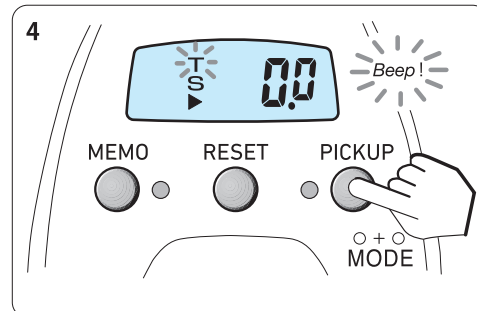

5. When the set time lapses, it automatically starts winding up the rig at maximum speed.

-An audible alarm will sound before the reel starts winding.

### Tips

- The time elapsed since the launching of the rig is indicated. It suggests the right timing for chumming and retrieving the rig.
- The chumming timer automatically starts when the water-depth counter indicates 7.0 m.

## Functional setting [8. Display recalibration]

### Display revision

You can recalibrate the counter should it not indicate an accurate depth compared to depth markings on your line.

### Use

*You can recalibrate the counter while you are fishing!*

(Example)

To recalibrate the counter to 100 m to comply with the depth identified as just 100 m by the color of the line, though the counter shows 103 m.

1. Press down the **MEMO (船止) BUTTON** and the **PICKUP (釣り止巻) BUTTON** simultaneously for 2 seconds to change to the mode screen, and then press the **PICKUP (釣り止巻) BUTTON** to change to the fishing history (actual time you fished) screen.

\*Refer to “How to Use the Mode Screen” on pages 26 and 27.

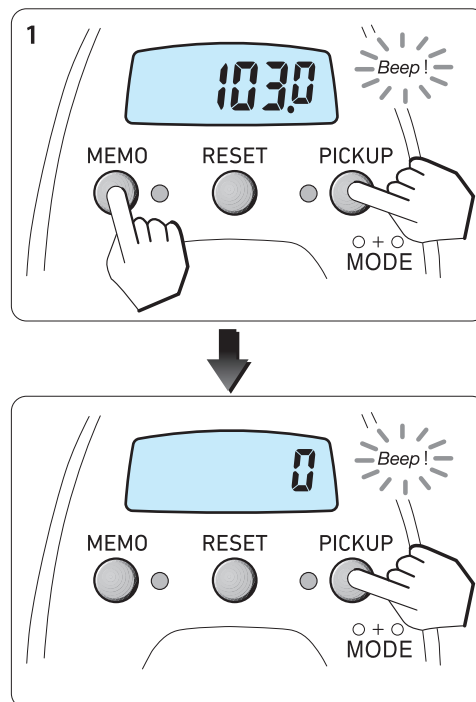

(In the figure, the screen shows 0 hour or it has not been used.)

## Functional setting [8. Display recalibration]

2. Press **RESET (リセット) BUTTON** and **PICKUP (フヨい止巻) BUTTON** at the same time for 2 seconds.  
This displays revision display.

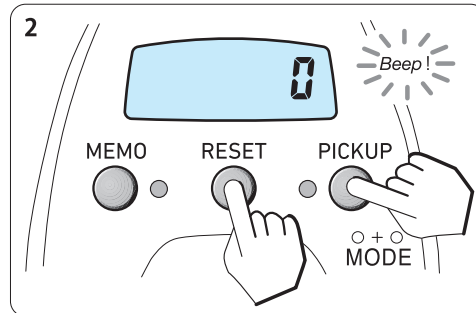

(Display recalibration)

3. Move the power lever to change the display's reading to 100.0.  
(Occasionally, for the revision rate, the exact number cannot be attained.)

\*If you cannot set it exactly at 100.0, set it at the nearest value.

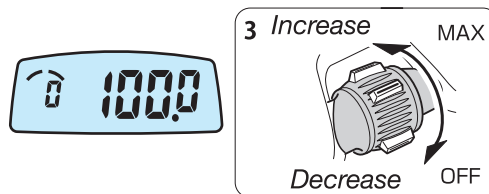

4. After 100.0 is reached, then press the **PICKUP (フヨい止巻) BUTTON** to return to depth display.

\*Pressing the **RESET (リセット) BUTTON** on the correction screen allows you to retain the display prior the correction (default value of ).

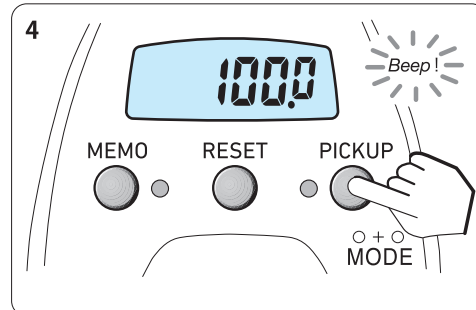

## Functional setting [9. Other useful functions]

### Various alarms



Many kinds of information are indicated by audible alarms such as auto stop alarm.

#### Jog Power Lever alarm

-When you place the Jog Power Lever at MAX or OFF position, an alarm beeps to tell you its position.

#### Auto stop alarm

-While winding up, an alarm shortly beeps starting 6 m below the auto stop point, at two meter intervals, to tell you that the rig is coming closer to the auto stop point. When it reached the auto stop point, an alarm sounds for longer.

#### Switch alarm

-Each time a button is pressed, a beep is sounded to allow you to confirm that you have surely pressed a button (You can set this alarm to OFF in the setting of functions from the Mode screen).

#### Excessive voltage alarm

-If you connected a power source with a voltage higher than the acceptable range, a continuous alarm will sound to warn you to stop operation. DO NOT operate the reel with such battery.

#### Timer winding alarm

-This alarm sounds to tell you before starting a chumming timer winding.

### Alarm sound ON/OFF setting

You can set the alarm sound to OFF.

-It is set to ON by default.

-Once the alarm sound has been set to OFF, the alarm will no longer sound even if you have pressed buttons or have used the power lever for operation.

1. Select "Alarm sound" in the Mode screen.

\*Refer to "How to Use the Mode Screen" on pages 26 and 27.

2. Select OFF with the Jog Power Lever.

3. Press PICKUP (フヨイ止巻) BUTTON. If the screen returns to the Water Depth screen, then the setting is completed.

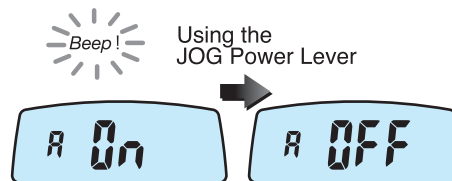

### Counter lamp

The lamp built in the counter always lights up.

-While the reel is powered ON, backlighting of the display always provides easier reading for fishing in the dark.

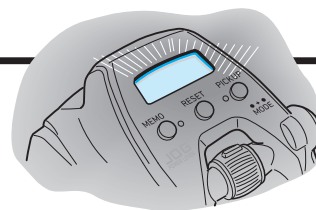

### Circuit breaker display

-For safety fishing, the circuit breaker is tripped by an overload onto the reel to stop electrical winding for 15 seconds. While the circuit breaker is tripped, it is displayed as shown in the figure.

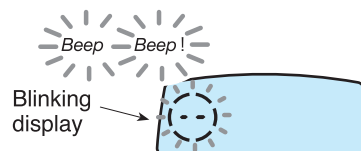

## Functional setting [10. How to remove the handle knob]

1. Holding the handle knob with your hand, loosen the handle knob cap by turning it counter-clockwise to loosen using a tool and remove it.

\*Please note that the part adopts left handed thread. Be sure to fit a tool kits properly onto the groove on the handle knob cap before turning it. Otherwise, the handle knob cap will be damaged while turning it.

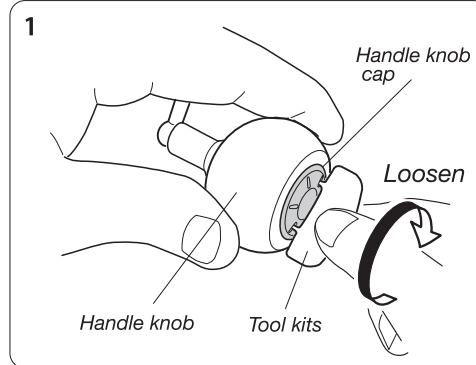

2. Loosen and remove the screw fixed inside of the knob using a screw driver.

\*Note that the screw is coated with a slack preventing agent and it is hardly loosened. Be careful not to damage the screw head.

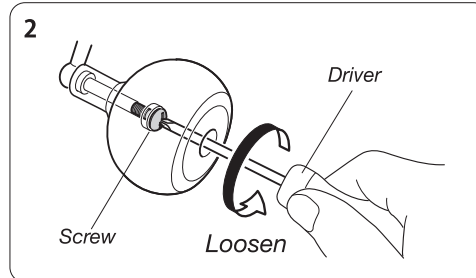

3. The handle knob is composed of as shown in the figure.

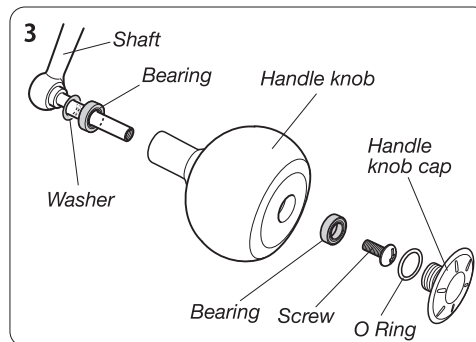



# Reel Specifications

## Reel Specification list

LEOBRITZ200J-L

<b>Product name</b>		00801473	
Gear ratio(manual winding)		4.8:1	
Weight (g)		460	
Max Drag power (kg)		8	
Line Capacity (m) **Bright** refers to our product "Tana Sensor Bright (PE)".	Bright (model-m)	1.5	450
		2	300
		3	100
		4	170
	Nylon (lb-m)	3	250
		4	170
		5	140
Number of ball bearings (Balls/rollers)		10/1	
Power-supply voltage		DC12V~16.8V	
Maximum winding power *1 (Kg)		35	
Normal winding speed (with 1kg load) *2(m/min)		148	
AFS standard winding power *3(Kg)		8	
JAFS standard winding speed *3(m/min)		185	
Current (A)	No load	3	
	Stall	6	
	Max	15	
Speed shifting	No load	0 – 185 m / min (continuous shifting)	
Compatible battery		DAIWA Super Lithium Series	

\*1:Maximum winding power: Reference value of shaft torque at supply voltage 13V (Kg=Kgf-cm)

\*2:Normal winding speed: Average winding speed of 100 m line with 1kg load at supply voltage 13V

\*3:JAFS standard winding speed / winding speed = Regulation of JFTMA (Japan Fishing Tackle Manufacturer's Association), actual measurement value at supply voltage 13V

## Counter display

Depth display range	Counter: 0.0 to 999.9 m
Usable temp. range	-10 to +60 (degrees centigrade)

\*The specifications are subject to change without prior notice for product improvement.

# Parts List

LEOBRITZ200J-L

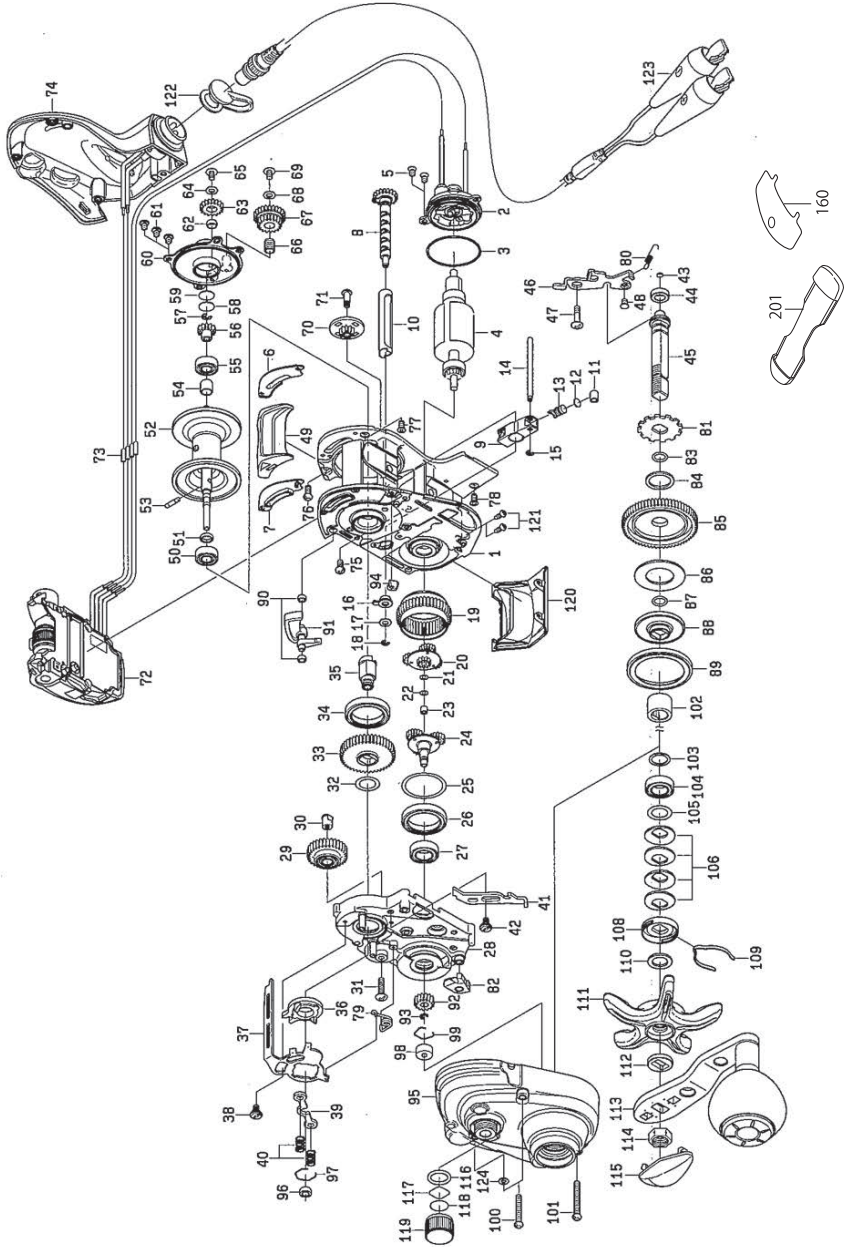

# Parts List

## LEOBRITZ200J-L

No.	Parts Name	No.	Parts Name	No.	Parts Name
1	FRAME	46	GEAR SHAFT PLATE	91	CLUTCH LEVER ( B )
2	MOTOR HOLDER	47	GEAR SHAFT PLATE SCREW ( A )	92	MOTOR GEAR ( C )
3	MOTOR HOLDER O-RING	48	GEAR SHAFT PLATE SCREW ( B )	93	PINION RETAINER
4	MOTOR	49	CLUTCH LEVER ( A )	94	LINE STOPPER
5	MOTOR HOLDER SCREW	50	SPOOL BALL BEARING	95	LS PLATE
6	CLUTCH PLATE ( R )	51	SPOOL BEARING COLLAR	96	SET PLATE GEAR ( B ) SHAFT COLLAR
7	CLUTCH PLATE ( L )	52	SPOOL ASSY	97	SET PLATE GEAR ( B ) SHAFT RING
8	WORM SHAFT	53	SPOOL PIN	98	LS BEARING
9	LEVEL WIND	54	SPOOL GEAR BEARING COLLAR	99	LS BEARING RING
10	WORM SHIELD	55	SPOOL GEAR BALL BEARING	100	LS PLATE SCREW ( A )
11	LEVEL WIND POST COLLAR	56	SPOOL GEAR	101	LS PLATE SCREW ( B )
12	PAWL WASHER	57	SPOOL GEAR RETAINER	102	DRAG COLLAR
13	PAWL	58	SPOOL WASHER ( A ) / 0.5	103	DRAG COLLAR WASHER
14	LEVEL WIND POST	59	SPOOL WASHER ( B ) / 0.2	104	HANDLE BALL BEARING
15	LEVEL WIND POST RETAINER	60	RS SETPLATE	105	HANDLE BEARING WASHER
16	WORM SHAFT COLLAR	61	RS SETPLATE SCREW	106	DRAG SPRING WASHER
17	WORM SHAFT WASHER	62	SETPLATE GEAR ( C ) COLLAR	108	DRAG HOLDER
18	WORM SHAFT RETAINER	63	SETPLATE GEAR ( C )	109	DRAG HOLDER LEAF SPRING
19	MOTOR HOUSE GEAR	64	SETPLATE GEAR ( C ) WASHER	110	STAR DRAG WASHER
20	MOTOR GEAR ( A )	65	SETPLATE GEAR ( C ) SCREW	111	STAR DRAG
21	MOTOR GEAR ( A ) WASHER/ 0.3	66	SETPLATE GEAR ( D ) COLLAR	112	HANDLE COLLAR
22	MOTOR GEAR ( A ) WASHER/ 0.1	67	SETPLATE GEAR ( D )	113	HANDLE ASSY
23	MOTOR GEAR ( B ) COLLAR	68	SETPLATE GEAR ( D ) WASHER	114	HANDLE NUT
24	MOTOR GEAR ( B )	69	SETPLATE GEAR ( D ) SCREW	115	HANDLE CAP
25	MOTOR HOUSE BEARING WASHER	70	FRAME GEAR	116	MECHANICAL BRAKE KNOB O-RING
26	MOTOR HOUSE BALL BEARING	71	FRAME GEAR SCREW	117	MECHANICAL BRAKE KNOB WASHER ( A )
27	MOTOR GEAR ( B ) BALL BEARING	72	IC MODULE	118	MECHANICAL BRAKE KNOB WASHER ( B )
28	LS SET PLATE	73	CORD COVER	119	MECHANICAL BRAKE KNOB
29	SET PLATE GEAR ( A )	74	RS PLATE	120	FINGER COVER
30	SET PLATE GEAR ( A ) COLLAR	75	RS PLATE SCREW ( A )	121	FINGER COVER SCREW
31	SET PLATE GEAR ( A ) SCREW	76	RS PLATE SCREW ( B )	122	CONNECTOR CAP
32	SET PLATE GEAR ( B ) WASHER	77	RS PLATE SCREW ( C )	123	CORD
33	SET PLATE GEAR ( B )	78	RS PLATE SCREW ( D )	124	LS PLATE SCREW WASHER
34	SET PLATE GEAR ( B ) BALL BEARING	79	CLUTCH CAM SPRING	150	HANDLE KNOB WASHER
35	SET PLATE GEAR ( B ) SHAFT	80	KICK LEVER SPRING	151	HANDLE KNOB COLLAR ( 4*7*2.5 )
36	CLUTCH CAM	81	RATCHET	152	HANDLE KNOB
37	CLUTCH CAM PLATE	82	STOPPER	153	HANDLE KNOB SCREW
38	CLUTCH CAM PLATE SCREW	83	GEAR SHAFT O-RING	154	HANDLE KNOB CAP
39	CLUTCH PLATE	84	DRIVE GEAR WASHER	200	MANUAL
40	CLUTCH SPRING	85	DRIVE GEAR	201	DRIVER
41	KICK LEVER	86	DRAG WASHER	202	LINE THROUGH PIN
42	KICK LEVER SCREW	87	GEAR SHAFT O-RING	203	STAND COVER
43	GEAR SHAFT WASHER	88	DRAG DISC COLLAR	204	JAPANESE LABEL
44	GEAR SHAFT COLLAR	89	DRAG PACKING	205	LOWER WINDING GAUGE
45	GEAR SHAFT	90	CLUTCH LEVER ( B ) COLLAR		

There may sometimes be a difference between the purchased reel and the Dismantled Parts Chart or the parts list above due to the adjustment process etc. We appreciate your understanding.

# Trouble shooting

Symptom	Possible causes	To do	Ref. page
Motor does not respond to the power lever.	The counter displays 0.0 m.	It is a normal function to avoid over winding. Pressing the <b>RESET BUTTON</b> prepares it to wind up.	29
	Did not pull the lever to OFF position.	Pull the lever to OFF and then move forward again to start winding.	13
	Unstable power source.	Use another power source, such as electric reel specific batteries.	9
Counter display does not appear.	Battery charge is low.	Recharge the battery.	9
	Cord worn or corroded.	Replace the cord.	11
	Incorrect battery connection.	Connect clips correctly without + / - reverse connection.	8
Auto stop function does not work.	Did not press <b>RESET BUTTON</b> at surface.	Set the surface depth to zero after setting rig.	28
	Error for sinker weight or rocking of the boat.	Adjust settings of auto stop function.	28,29
	Line is elongated.	Reset the depth counter at the surface.	28,29
There are counter errors.	Line length has increased due to stretching.	Re-enter line data.	16~25
		Recalibrate the water depth.	35,36
	Line was wound while powered off during fishing.	Re-enter line data.	
	<b>RESET BUTTON</b> was pressed and held while feeding the line.	Re-enter line data.	16~25
	Correction was made largely.	Release correction.	35,36
Pickup does not respond.	Speed setting is at zero.	Go to the Mode screen to set the Jigging again.	30

\*Contact your dealer if the reel does not function properly despite the above details being confirmed, in the event of other problems arising, and to order parts.

#### アフターサービスについて

本製品は当社の厳重な検査を経て出荷されたものですが、万一、故障が生じ修理が必要な場合、あるいは部品御注文の際はご購入の販売店、または下記のお客様センターまでお問い合わせください。なお、修理品は部品代のほか手数料をいただきますのでご了承ください。

お客様センター（無料） 携帯電話からもご利用できます

TEL **0120-506-204**

受付時間：9:00～17:00（土・日・祝祭日は除く）

ホームページ上からもご確認、お問い合わせできます

[www.daiwa.com/jp/](http://www.daiwa.com/jp/)

**グローブライド株式会社**

〒203-8511 東京都東久留米市前沢3-14-16