

FURUNO

NAVnet

TZ3 touch

MULTI FUNCTION DISPLAY

Model **TZT9F/TZT12F/TZT16F/TZT19F**



www.furuno.com

OPERATOR'S MANUAL

ECF

(Elemental Chlorine Free)

The paper used in this manual
is elemental chlorine free.

FURUNO ELECTRIC CO., LTD.

9-52 Ashihara-cho,
Nishinomiya, 662-8580, JAPAN

• FURUNO Authorized Distributor/Dealer

All rights reserved. Printed in Japan

Pub. No. OME-45120-D1

(TEHI) TZT19F/TZT12F/TZT16F

A : APR. 2020

D1 : JUL. 08, 2021



0 0 0 1 9 7 1 0 0 1 3

IMPORTANT NOTICES

General

- This manual has been authored with simplified grammar, to meet the needs of international users.
- The operator of this equipment must read and follow the instructions in this manual. Wrong operation or maintenance can void the warranty or cause injury.
- Do not copy any part of this manual without written permission from FURUNO.
- If this manual is lost or worn, contact your dealer about replacement.
- The contents of this manual and the equipment specifications can change without notice.
- The example screens (or illustrations) shown in this manual can be different from the screens you see on your display. The screens you see depend on your system configuration and equipment settings.
- Save this manual for future reference.
- Any modification of the equipment (including software) by persons not authorized by FURUNO will void the warranty.
- The microSDXC logo is a trademark of the SD Card Association.
- The SD, SDHC and SDXC logos are trademarks of SD-3 LCC.
- Apple, App Store, iPhone, iPod, iPad are registered trademarks of Apple Inc, registered in the USA and other countries.
- Android, Google and Google Play are registered trademarks of Google, Inc.
- FLIR and ClearCruise are registered trademarks of FLIR Systems, Inc.
- Fusion-Link and PartyBus are registered trademarks of FUSION Entertainment Ltd.
- The following concern acts as our importer in Europe, as defined in DECISION No 768/2008/EC.
 - Name: FURUNO EUROPE B.V.
 - Address: Ridderhaven 19B, 2984 BT Ridderkerk, The Netherlands
- The following concern acts as our importer in UK, as defined in SI 2016/1025 as amended SI 2019 470.
 - Name: FURUNO (UK) LTD.
 - Address: West Building Penner Road Havant Hampshire PO9 1QY, U.K.
- All brand and product names are trademarks, registered trademarks or service marks belong to their respective holders.

How to discard this product

Discard this product according to local regulations for the disposal of industrial waste. For disposal in the USA, see the homepage of the Electronics Industries Alliance (<http://www.eiae.org/>) for the correct method of disposal.

How to discard a used battery

Some FURUNO products have a battery(ies). To see if your product has a battery, see the chapter on Maintenance. If a battery is used, tape the + and - terminals of the battery before disposal to prevent fire, heat generation caused by short circuit.

In the European Union: The crossed-out trash can symbol indicates that all types of batteries must not be discarded in standard trash, or at a trash site. Take the used batteries to a battery collection site according to your national legislation and the Batteries Directive 2006/66/EU.

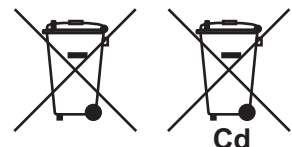

In the USA: The Mobius loop symbol (three chasing arrows) indicates that Ni-Cd and lead-acid rechargeable batteries must be recycled. Take the used batteries to a battery collection site according to local laws.

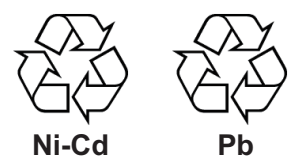

In the other countries: There are no international standards for the battery recycle symbol. The number of symbols can increase when the other countries make their own recycle symbols in the future.



SAFETY INSTRUCTIONS

Read these safety instructions before you operate the equipment.



WARNING

Indicates a condition that can cause death or serious injury if not avoided.



CAUTION

Indicates a condition that can cause minor or moderate injury if not avoided.



Warning, Caution



Prohibitive Action



Mandatory Action



WARNING



The radar antenna sends electromagnetic radio frequency (RF) energy. This energy can be dangerous to you, especially your eyes. Do not look at the radiator or near the antenna when the antenna is rotating.

The distances at which RF radiation levels of 100 W/m² and 10 W/m² exist are shown in the table.

Antenna Model	Distance to 100 W/m ² point	Distance to 10 W/m ² point	Antenna Model	Distance to 100 W/m ² point	Distance to 10 W/m ² point
DRS4D-NXT	N/A	0.7 m	DRS12A-NXT w/XN12A	0.2 m	2.4 m
DRS4DL	N/A	1.1 m	DRS12A-NXT w/XN13A	0.2 m	1.9 m
DRS4DL+	N/A	0.9 m	DRS12A X-Class w/XN12A	0.3 m	3.1 m
DRS6A-NXT w/XN12A	N/A	0.6 m	DRS12A X-Class w/XN13A	0.2 m	2.9 m
DRS6A-NXT w/XN13A	N/A	0.4 m	DRS25A-NXT w/XN12A	0.5 m	5.3 m
DRS6A X-Class w/XN10A	0.1 m	3 m	DRS25A-NXT w/XN13A	0.4 m	4.4 m
DRS6A X-Class w/XN12A	N/A	2.2 m	DRS25A X-Class w/XN12A	0.8 m	7.7 m
DRS6A X-Class w/XN13A	N/A	1.9 m	DRS25A X-Class w/XN13A	0.7 m	6.8 m



Check that no person is near the radar antenna before you turn on the radar.

Serious injury or death can occur if a person is hit by a rotating radar antenna.



Turn off the power immediately at the switchboard if water leaks into the equipment or smoke or fire is coming from the equipment.

Failure to turn off the equipment can cause fire or electrical shock.



The front panel of the display unit is made of glass. Handle it with care.

Injury can result if the glass breaks.



Do not open the equipment.

Only qualified persons can work inside the equipment.

WARNING



Keep units other than the radar antenna away from rain and water.

Fire or electrical shock can occur if water gets inside the equipment.



Do not disassemble or modify the equipment.

Fire or electrical shock can occur if the equipment is disassembled or modified.



Do not operate the equipment with wet hands.

Electrical shock can occur.



Do not depend on one navigation device for the navigation of the vessel.

Always check your position against all available aids to navigation, for the safety of vessel and crew.



A radar is an excellent anti-collision aid, but remember to keep watch for possible collision conditions.

Always keep a watch while underway.



Do not leave any objects near the radar antenna.

Fire, electrical shock or injury can result if something gets caught in the radar antenna.



Use the correct fuse.

A wrong fuse can cause fire or serious damage to the equipment.



Do not maneuver the vessel based on the depth indication alone.

Grounding can occur.

CAUTION



The fish finder picture is not refreshed when the picture advance setting is “OFF”.



Do not use high-pressure cleaners to clean this equipment.

This equipment has the waterproof rating outlined in the specifications, at the back of this manual. However, the use of high-pressure cleaning equipment can cause water ingress, resulting in damage to, or failure of, the equipment.

⚠ WARNING

⊘ The ARPA function is a valuable aid to navigation. However, the navigator must check all aids available to avoid collision.

- The ARPA automatically tracks an automatically or manually acquired radar target and calculates its course and speed, indicating them with a vector. Since the data generated by the ARPA depends on the selected radar targets, the radar must be optimally tuned for use with the ARPA, to ensure required targets will not be lost or unnecessary targets, like sea returns and noise, will not be acquired and tracked.
- A target is not always a landmass, reef, ship, but can also be returns from the sea surface and from clutter. As the level of clutter changes with the environment, the operator must correctly adjust the sea and rain clutter controls and the gain control so that the target echoes do not disappear from the radar screen.

⚠ CAUTION

The plotting accuracy and response of this ARPA meets IMO standards. Tracking accuracy is affected by the following:

- Tracking accuracy is affected by course change. One to two minutes is required to restore vectors to full accuracy after an abrupt course change. (The actual amount depends on gyrocompass specifications.)
- The amount of tracking delay is inversely proportional to the relative speed of the target. Delay is approx. 15-30 seconds for the higher relative speed; approx. 30-60 seconds for the lower relative speed. The following factors can affect accuracy:
 - Echo intensity
 - Radar transmission pulse length
 - Radar bearing error
 - Gyrocompass error
 - Course change (own ship and targets)

About the TFT LCD

The TFT LCD is constructed using the latest LCD techniques, and displays 99.99% of its pixels. The remaining 0.01% of the pixels may drop out or blink, however this is not an indication of malfunction.

Safety Labels

A safety label is attached to the display unit. Do not remove the label. If the label is missing or damaged, contact a FURUNO agent or dealer about replacement.



Name: Warning Label (2)
 Type: 03-129-1001-3
 Code No.: 100-236-743-10

TABLE OF CONTENTS

FOREWORD	xiv
SYSTEM CONFIGURATION	xvii
1. SYSTEM INTRODUCTION	1-1
1.1 Controls, Touchscreen Operations.....	1-1
1.2 Remote Control Units (option).....	1-5
1.2.1 Remote Control MCU-002.....	1-5
1.2.2 Remote Control Unit MCU-004.....	1-6
1.2.3 Control Unit MCU-005.....	1-8
1.2.4 Remote Control Unit group settings.....	1-10
1.3 How to Turn the Power On or Off.....	1-12
1.4 How to Adjust the Brilliance of the Display and Hue.....	1-14
1.5 Home Screen.....	1-15
1.6 How to Select a Display.....	1-17
1.6.1 How to select a display from the Home screen.....	1-17
1.6.2 How to select a display from the quick page.....	1-17
1.7 How to Edit the Display Icons.....	1-18
1.7.1 How to add a new display icon.....	1-18
1.7.2 How to edit a display icon.....	1-19
1.8 Edge Swipe Functions.....	1-20
1.9 Data Area.....	1-22
1.9.1 How to change the order of the data.....	1-23
1.9.2 How to change the contents of a data box.....	1-23
1.9.3 How to add data to a data area.....	1-24
1.9.4 How to delete a data box.....	1-24
1.9.5 How to change the display method for the data in a data box.....	1-25
1.9.6 How to adjust the transparency of the data area.....	1-25
1.9.7 How to display 3-axis speed from the SC-33/SCX-20.....	1-26
1.10 User Interface.....	1-27
1.11 MicroSD Cards.....	1-28
1.12 Chart Plotter Introduction.....	1-30
1.13 Radar Introduction.....	1-31
1.14 Sounder (Fish Finder) Introduction.....	1-32
1.15 Settings Menu.....	1-33
1.16 Two-Finger Tap Function.....	1-36
1.17 Language.....	1-37
1.18 Man Overboard (MOB).....	1-37
1.19 Wireless LAN Settings.....	1-39
1.19.1 How to connect the existing LAN.....	1-39
1.19.2 How to create a local wireless network.....	1-41
1.20 How to Create and Login to Your My TimeZero™ Account.....	1-42
1.21 PIN Code Lock.....	1-44
2. CHART PLOTTER	2-1
2.1 Chart Type.....	2-1
2.2 Range Zoom In, Zoom Out.....	2-2
2.3 Orientation Mode.....	2-3
2.4 How to Move the Chart.....	2-3
2.5 The Own Ship Icon.....	2-4
2.5.1 Description.....	2-4
2.5.2 How to show or hide the COG vector, heading line.....	2-4
2.5.3 COG vector length.....	2-4

TABLE OF CONTENTS

2.5.4	Own ship icon orientation.....	2-5
2.6	How to Find Information Chart Object and Chart Information	2-6
2.6.1	Chart object information	2-6
2.6.2	Chart information.....	2-7
2.7	How to Find the Range and Bearing Between Two Locations	2-7
2.8	Multiple Chart Plotter Displays	2-8
2.9	Cartographic Text and Objects on Vector Charts	2-9
2.9.1	Control visibility of text and object information in vector charts.....	2-9
2.9.2	Control visibility of cartographic objects in S-52 charts.....	2-10
2.10	Alarms	2-12
2.10.1	Cross Track Error alarm.....	2-13
2.10.2	Depth alarm.....	2-13
2.10.3	SST alarm	2-14
2.10.4	Speed alarm.....	2-15
2.10.5	Anchor watch alarm	2-15
2.10.6	Wind speed alarm	2-17
2.10.7	Low fuel alarm.....	2-17
2.10.8	Other Alarm menu items	2-17
2.10.9	Alarms list.....	2-18
2.11	Track	2-18
2.11.1	How to start, stop recording the track	2-18
2.11.2	How to show or hide the track display.....	2-19
2.11.3	Track recording interval.....	2-19
2.11.4	Track color	2-20
2.11.5	Track thickness	2-23
2.11.6	How to create a route with past track (follow track)	2-23
2.11.7	How to create a route with track currently being recorded (track back)	2-24
2.11.8	How to delete tracks.....	2-25
2.11.9	How to find the number of track points used.....	2-25
2.12	Chart Plotter Menu	2-26
2.13	NAVpilot Series Auto Pilot.....	2-27
2.13.1	How to enable use of the NAVpilot	2-28
2.13.2	How to show the NAVpilot control box in the data area	2-28
2.13.3	How to change the steering mode	2-29
2.13.4	How to change the NAVpilot settings.....	2-31
2.14	TZ iBoat.....	2-32
2.15	TZ First Mate.....	2-32
2.16	Photos	2-33
2.17	Fleet Tracking	2-35
2.17.1	How to set up fleet tracking.....	2-36
2.17.2	How to show/hide fleet target (sister ship) symbols	2-36
2.17.3	How to show fleet target information.....	2-36
2.17.4	How to clear fleet target symbols temporarily from the screen	2-37
2.17.5	Fleet target list.....	2-37
2.17.6	How to put a fleet target at the center of the chart plotter screen	2-39
2.17.7	How to share user objects.....	2-39
2.18	Fish-It.....	2-40
3.	3D DISPLAY, OVERLAYS.....	3-1
3.1	3D Display	3-1
3.1.1	How to activate the 3D display.....	3-2
3.1.2	How to make the 3D view clearer	3-3
3.2	Overlays	3-4
3.2.1	Depth shading overlay	3-4
3.2.2	Satellite photo overlay.....	3-6
3.2.3	Radar overlay.....	3-6

3.2.4	Tide info overlay	3-8
3.2.5	Tidal current overlay	3-10
3.2.6	How to show the ACCU-FISH icon on the overlay	3-12
4.	POINTS, BOUNDARIES	4-1
4.1	About Points & Event Marks	4-1
4.2	How to Enter Points, Event Marks	4-2
4.2.1	How to enter a point (chart plotter and radar displays only)	4-2
4.2.2	How to enter an event mark	4-3
4.2.3	How to enter an event mark at a specific location	4-5
4.3	How to Display Point, Event Mark, Catch Information	4-6
4.4	How to Enter a Comment for an Event Mark	4-6
4.5	Default Point, Event Mark Settings	4-7
4.5.1	Default point settings	4-7
4.5.2	Default event mark settings	4-8
4.6	How to Find Number of Points Used	4-9
4.7	Points List	4-10
4.7.1	How to show the Points list, process points	4-10
4.8	How to Move Points	4-13
4.8.1	How to move an on-screen point	4-13
4.8.2	How to move a point using the pop-up window	4-13
4.8.3	How to move a point using the Points list	4-13
4.9	How to Delete Points	4-13
4.9.1	How to delete an on-screen point	4-13
4.9.2	How to delete a point via the Points list	4-13
4.9.3	How to delete points collectively via the Points list	4-14
4.9.4	How to delete all points via the menu	4-14
4.10	How to Edit Points	4-15
4.10.1	How to edit an on-screen point	4-15
4.10.2	How to edit a point via the Points list	4-16
4.10.3	How to edit points collectively via the Points list	4-16
4.11	How to Move a Point to the Screen Center	4-17
4.12	How to Show or Hide All Points, Points Names	4-18
4.13	How to Set Point Naming Functions	4-18
4.14	How to Set Point Density	4-18
4.15	How to Go to a Point	4-19
4.15.1	How to go to an on-screen point	4-19
4.15.2	How to go to a position selected on screen	4-20
4.15.3	How to go to a point selected from the Points list	4-22
4.15.4	How to use the NAVpilot to steer to a point	4-23
4.15.5	How to display the point information for the active goto point	4-23
4.16	How to Restart or Cancel Navigation to a Point	4-24
4.16.1	How to restart navigation to a point	4-24
4.16.2	How to cancel navigation to a point	4-24
4.17	Boundaries	4-25
4.17.1	How to create a boundary	4-25
4.17.2	How to show or hide all boundaries	4-26
4.17.3	How to set default boundary attributes	4-27
4.17.4	Boundaries list	4-28
4.17.5	How to edit boundaries	4-31
4.17.6	How to add a point to a boundary	4-33
4.17.7	How to move a point on a boundary	4-33
4.17.8	How to delete a point from a line or area boundary	4-34
4.17.9	How to set an alarm for a boundary	4-34
4.17.10	How to find the number of boundary points used	4-35
4.17.11	How to display a boundary at the screen center	4-35

4.17.12	How to delete boundaries	4-36
5.	ROUTES.....	5-1
5.1	What is a Route?.....	5-1
5.2	How to Create a Route.....	5-2
5.2.1	How to create a route by selecting positions.....	5-2
5.2.2	How to create a route with points.....	5-3
5.2.3	How to create a route from the Points list	5-4
5.3	How to Edit a Route	5-4
5.3.1	How to insert a route point on a route	5-4
5.3.2	How to move a route point on a route	5-5
5.3.3	How to delete a point (incl. route point) on a route	5-5
5.3.4	How to extend a route	5-5
5.4	Routes List	5-6
5.5	How to Find Number of Routes Created	5-11
5.6	How to Find a Route on the Chart.....	5-11
5.7	How to Delete a Route	5-11
5.7.1	How to delete a route on the screen	5-11
5.7.2	How to delete a route via the Routes list.....	5-11
5.7.3	How to delete routes collectively via the Routes list	5-12
5.7.4	How to delete all routes.....	5-12
5.8	How to Show or Hide All Routes	5-12
5.9	How to Set Route Density	5-13
5.10	How to Follow a Route	5-13
5.10.1	How to follow an on-screen route.....	5-13
5.10.2	How to follow a route selected from the Routes list	5-14
5.10.3	How to start navigation from a route point	5-15
5.10.4	How to show the detailed information about a route	5-16
5.11	Operations Available When You Follow a Route	5-16
5.11.1	How to restart navigation	5-16
5.11.2	How to follow a route in the reverse direction	5-17
5.11.3	How to stop following a route	5-17
5.11.4	How to skip a point on a route.....	5-17
5.11.5	Waypoint switching mode	5-18
5.11.6	How to automatically zoom a route	5-18
5.11.7	XTE lines.....	5-18
5.11.8	Waypoint arrival notification	5-19
5.11.9	End of route notification	5-19
5.11.10	How continue navigation at end of route.....	5-19
5.11.11	Steering a route with the NAVpilot	5-20
5.12	SAR Operations	5-21
5.13	Fuel Level Indicators	5-24
5.14	Laylines	5-24
5.14.1	How to enable/disable the layline feature	5-24
5.14.2	How to show layline data in the data area	5-24
5.14.3	How to change the polar wind file	5-25
5.15	Routes Menu.....	5-26
6.	RADAR.....	6-1
6.1	How to Transmit, Set the Radar in Stand-by.....	6-1
6.2	Tuning	6-1
6.3	How to Adjust the Gain	6-2
6.4	How to Reduce the Sea Clutter.....	6-4
6.5	How to Reduce the Rain Clutter.....	6-4
6.6	Range Scale.....	6-5
6.7	Orientation Mode.....	6-5

6.8	How to Measure the Range and Bearing from Your Ship to a Target.....	6-6
6.8.1	How to display the range rings	6-6
6.8.2	How to set the number of the range rings to show	6-7
6.8.3	How to select the range rings mode	6-7
6.8.4	How to measure the range and bearing to an object	6-8
6.8.5	How to measure the range with the VRM.....	6-9
6.8.6	How to measure the bearing with the EBL	6-11
6.8.7	How to select the EBL reference	6-12
6.9	How to Measure the Range and Bearing Between Two Targets	6-13
6.10	How to Off-center the Picture	6-13
6.11	Heading Line	6-14
6.12	How to Reduce Radar Interference	6-14
6.13	Echo Average	6-15
6.14	Guard Zone	6-15
6.14.1	How to set a guard zone	6-15
6.14.2	How to activate or deactivate a guard zone	6-16
6.14.3	How to hide a guard zone	6-17
6.15	Watchman	6-17
6.16	Echo Trail	6-18
6.16.1	How to show, hide echo trails.....	6-18
6.16.2	How to clear echo trails	6-18
6.16.3	How to select echo trail length	6-18
6.16.4	How to select the echo trail mode (reference).....	6-19
6.16.5	How to select echo trail color	6-19
6.16.6	How to select echo trail shading.....	6-20
6.17	How to Show, Hide or Cancel an Active Route	6-20
6.18	How to Show or Hide the Own Ship Icon	6-20
6.19	Echo Color.....	6-21
6.20	Background Color	6-21
6.21	Dual-Range Display.....	6-22
6.22	Bird Mode	6-23
6.23	Target Analyzer™	6-24
6.24	RezBoost™	6-27
6.25	ARPA Operation	6-28
6.25.1	How to show or hide the ARPA display	6-28
6.25.2	How to manually acquire a target.....	6-29
6.25.3	How to automatically acquire a target	6-29
6.25.4	How to automatically acquire targets by Doppler	6-30
6.25.5	How to display target data.....	6-30
6.25.6	How to stop tracking targets	6-31
6.25.7	ARPA list	6-31
6.25.8	How to clear lost targets	6-32
6.25.9	CPA/TCPA alarm	6-33
6.25.10	CPA graphic display	6-34
6.26	Connecting With FAR-2xx7/FAR-15xx Series Marine Radars	6-35
6.27	Radar Menu.....	6-36
6.28	How to Interpret the Radar Display	6-37
6.28.1	False echoes	6-37
6.28.2	Search and rescue transponder (SART).....	6-39
6.28.3	RACON (Radar Beacon).....	6-40
7.	FISH FINDER (SOUNDER)	7-1
7.1	How the Fish Finder Operates.....	7-1
7.2	How to Transmit, Go to Stand-by	7-2
7.3	How to Select a Display.....	7-2
7.3.1	Single frequency display	7-2

TABLE OF CONTENTS

7.3.2	Dual frequency display.....	7-3
7.3.3	Zoom displays.....	7-4
7.3.4	A-scope display (monitoring only).....	7-5
7.3.5	Bottom discrimination display.....	7-6
7.4	How to Select the Range.....	7-7
7.5	How to Adjust the Gain.....	7-7
7.5.1	Automatic gain adjustment.....	7-7
7.5.2	Manual gain adjustment.....	7-8
7.6	How to Reduce Clutter.....	7-9
7.7	Picture Advance Speed.....	7-10
7.8	How to Reduce Interference.....	7-11
7.9	How to Erase Unnecessary Echoes.....	7-11
7.10	How to Measure Range, Depth to an Object.....	7-12
7.11	Echo History Display.....	7-12
7.12	How to Balance Echo Strength.....	7-13
7.13	Fish Finder Alarms.....	7-14
7.13.1	How to set an alarm.....	7-14
7.13.2	How to activate or deactivate an alarm.....	7-15
7.13.3	Alarm sensitivity.....	7-15
7.14	ACCU-FISH™.....	7-16
7.14.1	How to set ACCU-FISH™.....	7-16
7.14.2	Fish size correction.....	7-17
7.14.3	How to turn the fish symbol indication on or off.....	7-17
7.14.4	How to display the fish information.....	7-17
7.14.5	How to set the minimum size of ACCU-FISH™ symbols.....	7-17
7.15	RezBoost™.....	7-18
7.16	White Edge.....	7-18
7.17	Water Temperature Graph.....	7-19
7.18	Preset Frequency.....	7-20
7.19	Fish Finder Menu.....	7-22
7.20	Interpreting the Display.....	7-26
8.	MULTI BEAM SONAR DFF-3D.....	8-1
8.1	Menu Operations.....	8-1
8.1.1	How to start/stop transmission.....	8-1
8.1.2	How set the background color.....	8-1
8.1.3	How to adjust the bottom range shift.....	8-2
8.1.4	How to change the transmission rate.....	8-2
8.2	Display Screens Overview.....	8-3
8.3	Multi-Sounder Display Operations.....	8-6
8.3.1	How to switch between TX and STBY.....	8-6
8.3.2	How to switch between single beam and triple beam presentations.....	8-6
8.3.3	How to set the TX beam angle.....	8-6
8.3.4	How to set the TX beam width.....	8-7
8.3.5	How to change the picture advance speed.....	8-7
8.3.6	How to change the display mode.....	8-7
8.3.7	How to show or hide the depth and frequency indications.....	8-7
8.3.8	Availability of points and event marks registration, and go to a point.....	8-8
8.4	Side Scan Display Operations.....	8-8
8.4.1	How to switch between TX and STBY.....	8-9
8.4.2	How to change echo color.....	8-9
8.4.3	How to show or hide the depth and frequency indications.....	8-9
8.4.4	Availability of points and event marks registration, and go to a point.....	8-9
8.5	Cross Section Display Operations.....	8-10
8.5.1	How to switch between TX and STBY.....	8-10
8.5.2	How to show or hide the grid.....	8-10

8.5.3	Zoom display	8-11
8.5.4	How to smooth echoes (distance)	8-11
8.5.5	How to smooth echoes (time).....	8-11
8.5.6	How to apply correction to the speed of sound	8-11
8.5.7	How to show or hide the depth and frequency indications	8-12
8.5.8	Availability of points and event marks registration, and go to a point.....	8-12
8.6	3D Sounder History Display Operations.....	8-13
8.6.1	How to switch between TX and STBY.....	8-13
8.6.2	How to move, zoom in, zoom out the viewpoint position.....	8-13
8.6.3	How to mark school of fish	8-14
8.6.4	How to stop advancement of the display.....	8-14
8.6.5	How to adjust the echo detection level.....	8-14
8.6.6	How to calibrate the seabed echo	8-14
8.6.7	How to use the bathymetry smoothing	8-14
8.6.8	How to use terrain shading.....	8-15
8.6.9	How to change the picture advance speed	8-15
8.6.10	Depth/Color Shading display	8-16
8.6.11	How to show or hide the depth and frequency indications	8-19
8.6.12	Availability of points and event marks registration, and go to a point.....	8-19
8.7	PBG Recording.....	8-20
8.7.1	How to create PBG recordings.....	8-20
8.7.2	How to set the speed filter.....	8-20
8.7.3	How to display, arrange a PBG recording	8-21
8.7.4	How to delete PBG recordings	8-21
8.7.5	How to apply correction to the speed of sound	8-22
9.	FILE OPERATIONS	9-1
9.1	File Format	9-1
9.2	How to Export User Objects	9-2
9.3	How to Import User Objects	9-2
9.4	How to Export, Import Tracks.....	9-3
9.5	How to Export, Import PBG Recordings	9-4
9.6	How to Export (Backup) the Equipment Settings	9-4
9.7	How to Import the Equipment Settings	9-5
9.8	My TimeZero Cloud Data Service	9-6
9.8.1	How to save settings/data to the cloud.....	9-6
9.8.2	How to retrieve settings/data from the cloud	9-6
10.	CAMERA/VIDEO/EXTERNAL EQUIPMENT	10-1
10.1	How to Display a Video Image	10-1
10.2	Video Signal Types.....	10-2
10.3	How to Set the Camera Display	10-3
10.3.1	How to set the video signal	10-3
10.3.2	How to switch your video inputs	10-7
10.3.3	How to adjust the image size	10-7
10.3.4	How to adjust the video image	10-7
10.4	Control of FLIR Camera	10-7
10.5	Operating External Equipment	10-9
10.6	Sonar Video.....	10-11
11.	FUSION-Link	11-1
11.1	FUSION Display	11-1
11.2	FUSION Operation Bar.....	11-4
11.3	FUSION Settings	11-5

12. INSTRUMENT-RELATED DISPLAYS	12-1
12.1 How to Show the Instrument Display	12-1
12.2 Instrument Displays.....	12-2
12.2.1 Full-screen instrument displays.....	12-2
12.2.2 Three-way, four-way split screen instrument display	12-6
12.2.3 How to switch between instrument displays.....	12-10
12.3 How to Edit the Instrument Displays	12-11
12.3.1 How to prepare for editing.....	12-11
12.3.2 How to rearrange the indications in an instrument display.....	12-11
12.3.3 How to edit, remove an indication in an instrument display	12-12
12.3.4 How to add an indication to an instrument display.....	12-14
12.3.5 How to rename an instrument display.....	12-14
12.3.6 How to remove an instrument display.....	12-14
12.3.7 How to add an instrument display.....	12-15
12.3.8 SC-33/SCX-20 3-axis speed display.....	12-15
12.4 Instrument Theme	12-16
12.5 Fuel Management System	12-16
12.5.1 How to manually enter fuel tank capacity.....	12-16
12.5.2 How to check remaining fuel amount.....	12-17
12.6 CZone	12-18
12.6.1 How to use CZone	12-18
12.6.2 CZone control.....	12-19
12.6.3 CZone modes.....	12-21
12.6.4 CZone monitoring.....	12-24
12.7 Yamaha Engine Status Display.....	12-26
12.7.1 How to show the display	12-28
12.7.2 Display examples.....	12-29
12.7.3 How to switch between displays	12-30
12.7.4 How to select the data to display in a data box.....	12-30
12.7.5 Troll mode	12-21
12.7.6 Trouble codes	12-32
12.7.7 Alarm list	12-32
13. WEATHER OPERATIONS.....	13-1
13.1 Weather Display Introduction	13-1
13.2 NavCenter Weather	13-2
13.2.1 How to set up for NavCenter weather.....	13-2
13.2.2 How to download the NavCenter weather data.....	13-3
13.2.3 How to display the NavCenter weather data.....	13-4
13.2.4 How to load a weather file.....	13-6
13.3 SiriusXM Weather	13-6
13.3.1 How to set up for SiriusXM weather.....	13-7
13.3.2 How to display the SiriusXM weather data.....	13-8
13.4 Weather Icons (SiriusXM Weather).....	13-9
13.5 Weather Data (NavCenter or SiriusXM Weather)	13-10
13.6 SiriusXM Weather Diagnostics.....	13-13
13.7 SiriusXM Satellite Radio.....	13-14
13.7.1 How to enable the radio	13-14
13.7.2 How to operate the radio controls	13-15
13.7.3 Radio diagnostics.....	13-16
13.8 Fish Mapping.....	13-17
13.8.1 How to show the fish mapping display	13-17
13.8.2 Fish mapping features.....	13-18
13.8.3 How to show fish mapping data	13-22
13.8.4 How to change fish mapping settings	13-22

14. AIS, DSC MESSAGE	14-1
14.1 What is AIS?	14-1
14.2 How to Show or Hide the AIS Symbols	14-1
14.3 AIS Target Symbols.....	14-1
14.4 Proximity AIS Target Alarm	14-3
14.5 How to Ignore Slow Moving AIS Targets.....	14-3
14.6 How to Display AIS Safety Messages	14-3
14.7 How to Display AIS Target Data.....	14-4
14.8 How to Show or Hide the Target IDs	14-4
14.9 AIS List	14-5
14.10AIS SART	14-6
14.11CPA/TCPA Alarm	14-7
14.12How to Register an AIS or DSC Target to the Buddies List.....	14-8
14.13CPA Graphic Display	14-9
14.14AIS Transponder FA-30, FA-50	14-10
14.15DSC Message Information.....	14-11
14.15.1DSC distress message	14-11
14.15.2How to set a DSC marker as destination	14-11
14.15.3How to display DSC marker information	14-11
14.15.4The DSC list	14-12
15. OTHER FUNCTIONS	15-1
15.1 General Menu.....	15-1
15.2 Units Menu	15-3
15.3 Initial Setup Menu.....	15-5
15.4 Facsimile Receiver FAX-30	15-10
15.5 How to Check for Software Updates	15-11
15.6 How to Manage Your Charts	15-12
15.6.1 How to view your charts	15-12
15.6.2 How to update or add charts	15-13
15.6.3 How to delete charts.....	15-14
16. MAINTENANCE, TROUBLESHOOTING	16-1
16.1 Maintenance	16-1
16.2 Fuse Replacement	16-2
16.3 Life of Parts	16-2
16.4 Troubleshooting.....	16-3
16.4.1 General troubleshooting	16-3
16.4.2 Chart plotter troubleshooting	16-4
16.4.3 Radar troubleshooting	16-4
16.4.4 Fish finder troubleshooting	16-5
APPENDIX 1 MENU TREE	AP-1
APPENDIX 2 TRANSDUCER LIST	AP-15
APPENDIX 3 ALERT MESSAGES	AP-18
APPENDIX 4 RADIO REGULATORY INFORMATION	AP-24
SPECIFICATIONS	SP-1
INDEX	IN-1

FOREWORD

A Word to the Owner

Congratulations on your choice of Multi Function Display, a member of the NavNet TZtouch3 family of multi-function displays. We are confident you will see why the FURUNO name has become synonymous with quality and reliability.

Since 1948, FURUNO Electric Company has enjoyed an enviable reputation for innovative and dependable marine electronics equipment. This dedication to excellence is furthered by our extensive global network of agents and dealers.

Your equipment is designed and constructed to meet the rigorous demands of the marine environment. However, no machine can perform its intended function unless properly installed and maintained. Please carefully read and follow the operation and maintenance procedures set forth in this manual.

We would appreciate feedback from you, the end-user, about whether we are achieving our goal. Thank you for considering and purchasing FURUNO.

Features

The NavNet TZtouch3, equipped with a touch screen with multi touch capacity, is a networked navigation system that gives you functions such as radar, chart plotter, fish finder and AIS. Information is transferred between NavNet TZtouch3 units through Ethernet or NMEA 2000. The plug-and-play format allows expansion and you can connect a maximum of six NavNet TZtouch3 units. Also, you can control the NavNet TZtouch3 units and display their data on an iOS or Android™ device.

Main features

- Intuitive touch control operation.
- The NavNet TZtouch3 units can be controlled and monitored from the following applications*.

Application*	Capability	iOS	Android™
NavNet Remote	Monitor or operate NavNet TZtouch3	iPad only	7 inch or larger
	Monitor NavNet TZtouch3	Other than iPad	7 inch or larger
NavNet Viewer	Display nav data, fish finder picture.	Yes	Yes
NavNet Controller	Remote control of NavNet TZtouch3.	Yes	Yes

* Check compatibility with your OS version in the respective store before downloading. Applications are available from the App Store (iOS) or Google Play™ (Android) at no cost.

- Instrument display provides comprehensive navigation data with connection of appropriate sensors.
- Points (waypoints) and routes can be transferred and shared between NavNet TZtouch3 units, via Ethernet.
- Large memory stores 30,000 Track Points, 30,000 Points, 200 Routes, 200 Boundaries, 1000 Photos, and 1000 Catches.

- Able to write and read data (points, routes, tracks, etc.) using a micro SD card.
- Built in GPS receiver and antenna. (TZT9F/12F/16F only)
- AIS function (requires connection of AIS transponder) receives AIS data from AIS equipped vessels, shore stations and navigational aids and displays relevant data.
- Built in fish finder available with single or dual frequency transducer.
- ACCU-FISH™ provides at-a-glance estimation of length and depth of individual fish. (Requires ACCU-FISH™ capable transducer.)
- Bottom discrimination display helps identify probable bottom composition with graphics and colors. (Requires bottom discrimination display capable transducer.)
- RezBoost™ raises echo resolution to see fish echoes clearly. (Requires RezBoost™ capable transducer. Not available when the transducer is installed with the inside hull installation method.)
- CHIRP transducer provides high resolution, low-noise pictures of underwater conditions.
- Dual-range radar display for watch on short and long distances at the same time.
- DSC (Digital Selective Calling) message information feature provides the MMSI no. and position of vessels that have transmitted a DSC message to you. (Requires DSC capable radiotelephone.)
- Control audio of FUSION-Link™ equipment.
- HDMI output (type A receptacle). (TZT12F/16F/19F only)
- Monitoring of the inside/outside of your ship via analog camera (FLIR™, AXIS™). (TZT9F does not support this feature.)
- Monitoring around the vessel with pan-tilt-zoom capable (PTZ) cameras (FLIR™, AXIS™).
- HDMI input and USB touch output for control of external application. (TZT16F/19F)

Software used in this product

This equipment uses the following open source software.

- Ubiquitous QuickBoot Copyright© Ubiquitous Corp. All rights reserved.
- This product includes software to be licensed under the GNU General Public License (GPL) version 2.0, GNU Lesser General Public Software License (LGPL) version 2.0, Apache, BSD and others. The program(s) is/are free software(s), and you can copy it and/or redistribute it and/or modify it under the terms of the GPL version 2.0 or LGPL version 2.0 as published by the Free Software Foundation. Please access to the following URL if you need source codes: https://www.furuno.co.jp/contact/cnt_oss01.html.

Program no.

System: 1950212-02.**

Application: 1950213-02.**

** denotes minor modifications.

CE declaration

With regards to CE declarations, please refer to our website (www.furuno.com), for further information about RoHS conformity declarations.

Standards used in this manual

- Key names are shown in boldface type. For example, **ENT** key (on the MCU-002, MCU-004 or MCU-005).
- Menu items, on-screen indications, and the names of pop-up menus and pop-up windows are shown in brackets. For example, the [Settings] menu.
- Messages shown on the screen (including the Status bar) are enclosed in quotations. For example, "No Network Connected".
- The [Settings] menu is comprised of several sub menus. When you are asked to select one of its sub menus, "[Settings]" is followed by an arrow and the sub menu name. For example, "Tap [Settings]→[General]".
- The colors mentioned in this manual are the default colors. Your colors may be different.
- Most of the screenshots in this manual are taken from the TZT19F. Layouts may be slightly different if you have a different unit.

SYSTEM CONFIGURATION

TZT9F System configuration

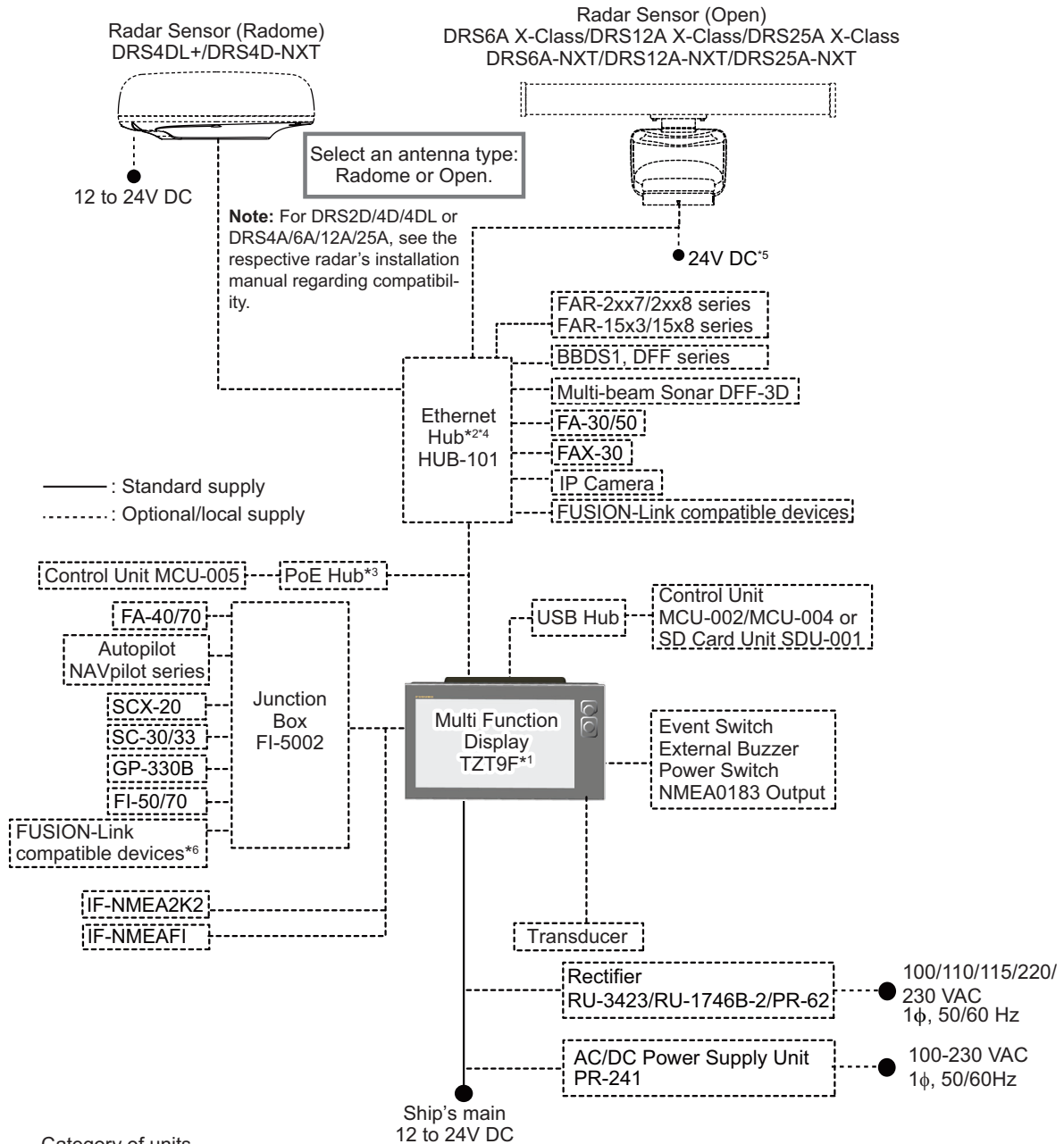

Category of units

Antenna unit: Exposed to the weather.

Other units: Protected from the weather.

*1: This unit has a built-in fish finder as standard.

*2: A maximum of 6 units of NavNet TZtouch2/3 can be connected. NavNet TZtouch2 requires software version 7. For configurations with TZT2BB included, a maximum of 4 NavNet TZtouch2/3 units can be connected. NavNet TZtouch cannot be connected.

*3: Use a commercially available PoE hub. "GS108PE" of NETGEAR has tested compatible. The basic functions of the hub were verified, however the compatibility of all functions were not checked. FURUNO cannot guarantee proper operation.

*4: FURUNO networks allow a maximum of three HUB-101 units on the same network.

*5: DRS6A-NXT is rated for either 12 V or 24 V DC power supply.

*6: The connected FUSION-Link device must also have CAN bus connectivity.

TZT12F System configuration

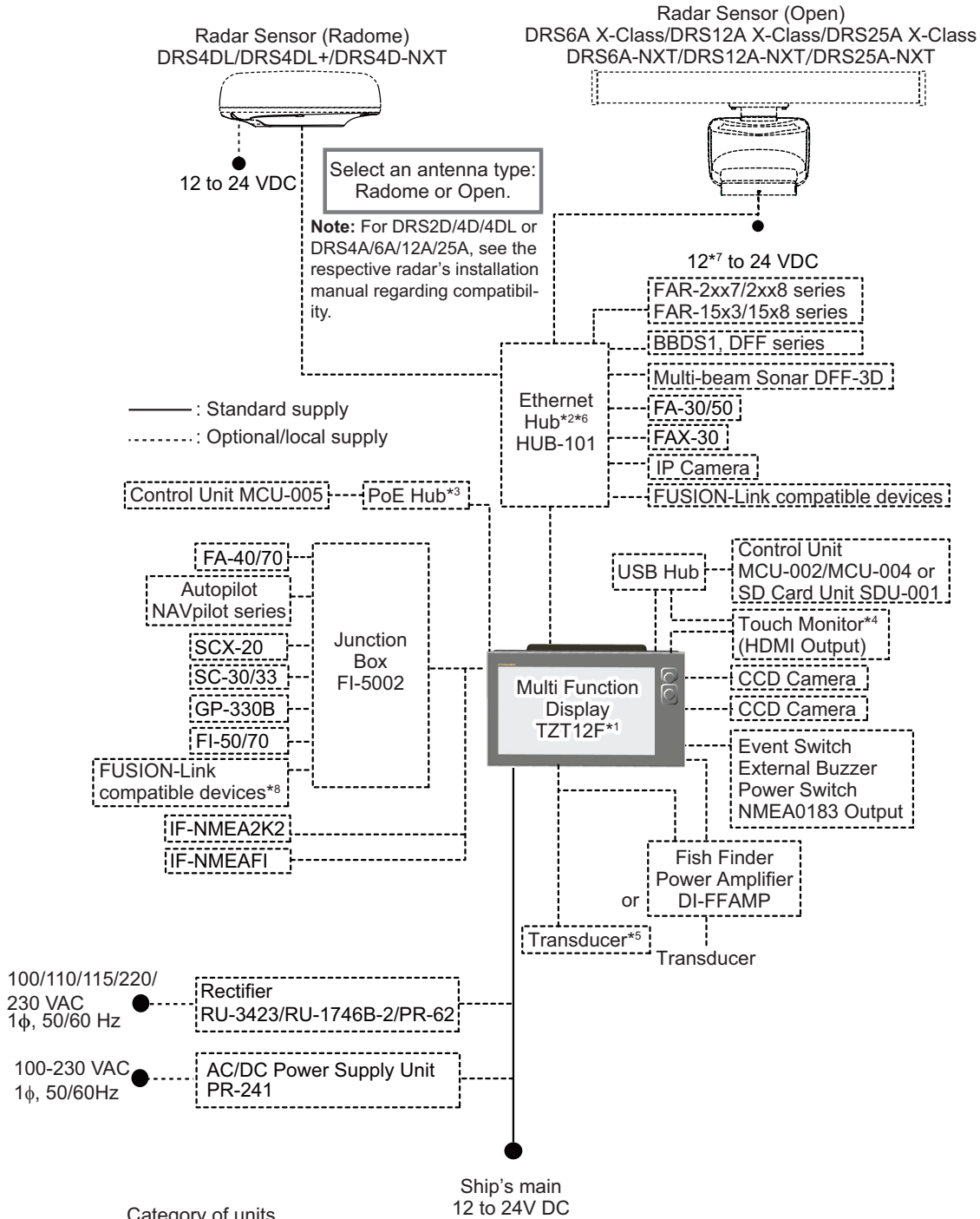

Category of units

Antenna unit: Exposed to the weather.
 Other units: Protected from the weather.

- *1: This unit has a built-in fish finder as standard.
- *2: A maximum of 6 units of NavNet TZtouch2/3 can be connected. NavNet TZtouch2 requires software version 7, which is to be released in Spring 2020. For configurations with TZT2BB included, a maximum of 4 NavNet TZtouch2/3 units can be connected. NavNet TZtouch cannot be connected.
- *3: Use a commercially available PoE hub. "GS108PE" of NETGEAR has tested compatible. The basic functions of the hub were verified, however the compatibility of all functions were not checked. FURUNO cannot guarantee proper operation.
- *4: The HDMI output resolution is fixed to 1280×800. To use a touch monitor for operation, its resolution must be 1280×800 (Aspect ratio 16:9) and with HPD (Hot Plug Detection) function.
- *5: Some transducers require connection of 12-10 pin conversion cable.
- *6: 12 VDC is only used with DRS6A-NXT.
- *7: FURUNO networks allow for a maximum of three Ethernet Hub HUB-101s. Exceeding this can cause undesirable results.
- *8: The connected FUSION-Link device must also have CAN bus connectivity.

TZT16F/TZT19F System configuration

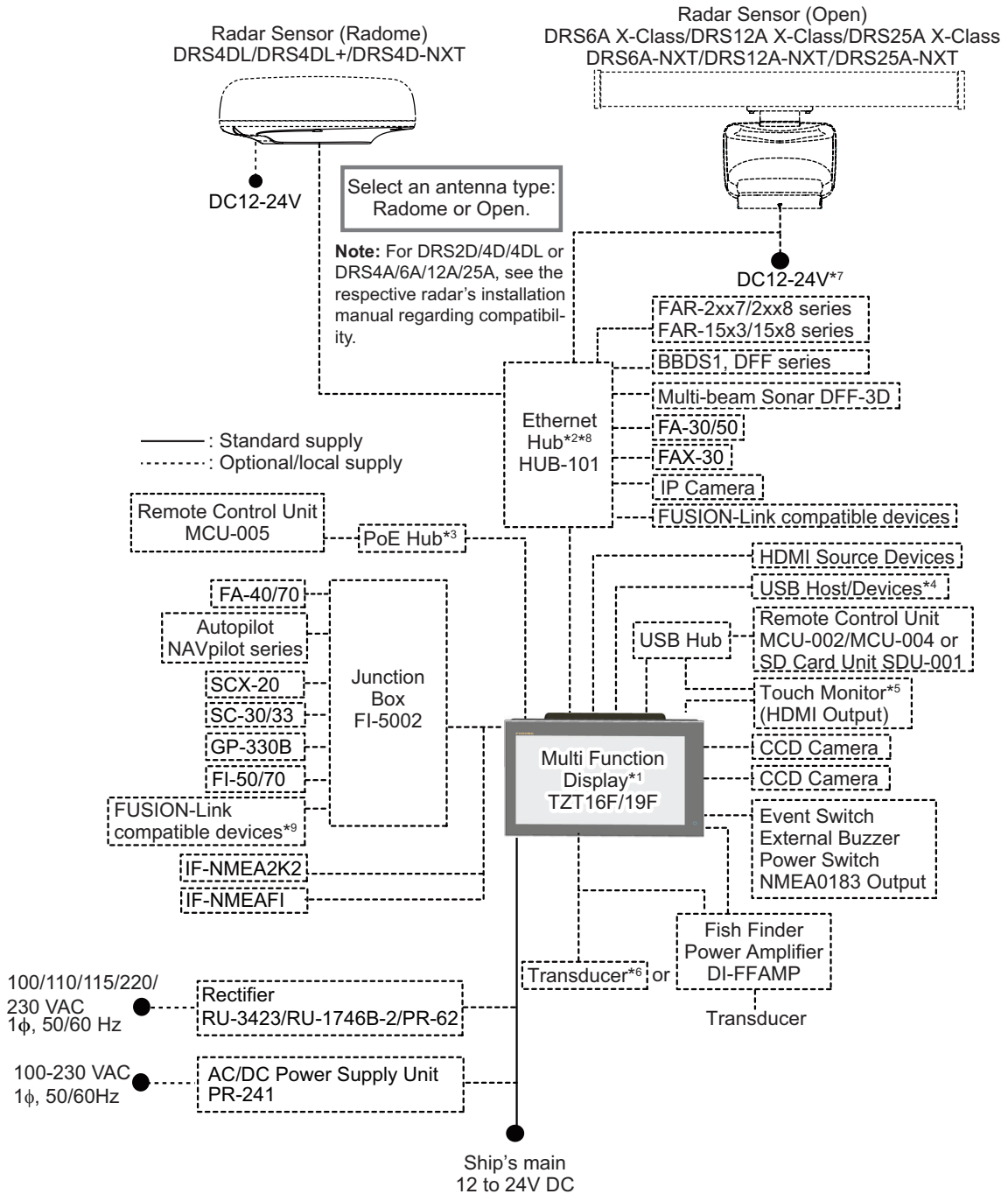

Category of units

Antenna unit: Exposed to the weather.
 Other units: Protected from the weather.

- *1: This unit has a built-in fish finder as standard.
- *2: A maximum of 6 units of NavNet TZtouch2/3 can be connected. NavNet TZtouch2 requires software version 7 or later. For configurations with TZT2BB included, a maximum of 4 NavNet TZtouch2/3 units can be connected. NavNet TZtouch cannot be connected.
- *3: Use a commercially available PoE hub. The NETGEAR GS108PE has tested as compatible. The basic functions of the hub were verified, however the compatibility of all functions were not checked. FURUNO cannot guarantee proper operation.
- *4: When using a USB OTG as a USB host device, this equipment operates as a touch operation output device.
- *5: The HDMI output resolution is fixed to 1920x1080. To use a touch monitor for operation, its output resolution must be 1920x1080 (Aspect ratio 16:9) with HPD (Hot Plug Detection) function.
- *6: Some transducers require connection of a 12-to-10 pin conversion cable.
- *7: 12 VDC is only used with DRS6A-NXT. All other open array DRS sensors require 24 VDC.
- *8: FURUNO networks allow for a maximum of three Ethernet Hub HUB-101s. Exceeding this can cause undesirable results.
- *9: The connected FUSION-Link device must also have CAN bus connectivity.

This page is intentionally left blank.

1. SYSTEM INTRODUCTION

1.1 Controls, Touchscreen Operations

The multi function display unit is operated with a touchscreen and keys (TZT9F/12F only). An optional remote controller also controls operations.

Control description

TZT9F/TZT12F

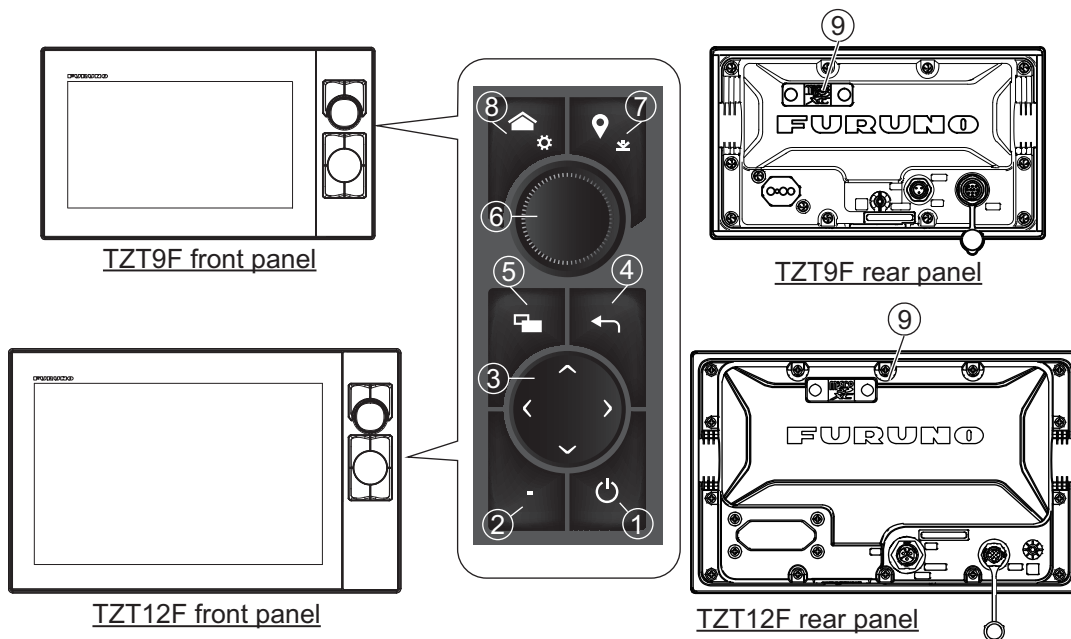

No.	Item	Function
1	 (Power switch)	<ul style="list-style-type: none"> • Short push: Turns the power on. With the unit powered, the [Quick Access] window appears. <u>[Quick Access] window</u> <ul style="list-style-type: none"> • Toggles radar, fish finder, multibeam sonar, and NavPilot between transmit and stand-by. • Adjust the brilliance and hue of the display. • Turns the power off (device or network). • Locks, unlocks the touchscreen.
2	FUNC key	<ul style="list-style-type: none"> • Short push: Performs the task assigned to the “two finger tap function” • Long push: Performs the task assigned to the “two finger long tap function”
3	CursorPad	Moves the cursor.
4	Center/ESC key	<ul style="list-style-type: none"> • Centers the own ship icon. • Returns to previous menu. • Disables the fish finder’s scrollbar function. • Undoes current operation.
5	Display Switching key	<ul style="list-style-type: none"> • Short push: Switches the active display in split-screen display. • Long push: Switches between the active split-screen display and full-screen display.

1. SYSTEM INTRODUCTION

No.	Item	Function
6	RotoKey™	<ul style="list-style-type: none"> • Push: Selects cursor position (pop-up menu appears). Also, confirms selected item. • Rotate: Selects the range on the chart plotter, radar, and fish finder displays. Also, selects menu items.
7	Event/MOB key	<ul style="list-style-type: none"> • Short push: Creates an event mark at the boat's location. • Long push: Creates an MOB at the boat's location.
8	Home key	<ul style="list-style-type: none"> • Short push: Opens the Home screen. • Long push: Opens the [Settings] menu.
9	MicroSD card slot	Slot for chart card.

TZT16F/TZT19F

The touch switch on the front panel controls power and brilliance. The rear panel contains a micro SD card slot.

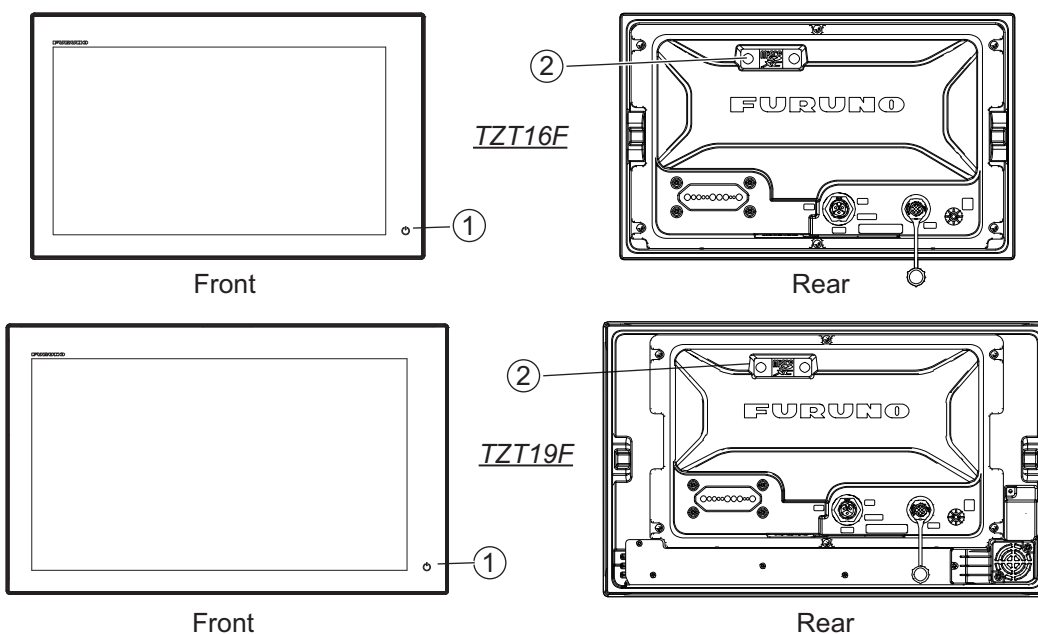

No.	Item	Function
1	 (Power switch)	<ul style="list-style-type: none"> • Short push: Turns the power on. With the unit powered, the [Quick Access] window appears. • <u>[Quick Access] window</u> • Toggles radar, fish finder, multibeam sonar, and Navpilot between transmit and stand-by. • Adjust the brilliance, hue and day/night mode of the display. • Turns the power off (device or network). • Locks, unlocks the touchscreen.
2	MicroSD card slot	Slot for chart card.

Soft cover

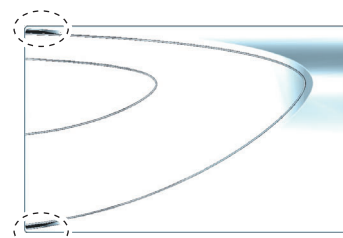

The soft cover protects the LCD when the display unit is not in use. To remove the cover, grasp the cover at the locations circled in the figure at right and pull forward.







Touchscreen operations

The tables which follow outline the touchscreen operations.

Operations with a finger

Operation with a finger		Function
Tap		<ul style="list-style-type: none"> • Select a menu item. • Select an object or position to display the corresponding pop-up menu.
Long tap		<ul style="list-style-type: none"> • Edit display icon (on Home screen).
Drag		<ul style="list-style-type: none"> • Pan the charts. • Scroll the menu.
Swipe		<ul style="list-style-type: none"> • Show the Slide-out menu, Layers menu (see section 1.8).

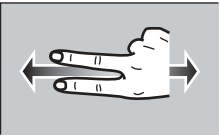
Operations with two fingers

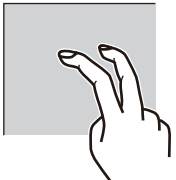
Operation with two fingers		Function
Pinch	  Zoom in Zoom out	<ul style="list-style-type: none"> • Zoom in or out the display range in the 2D/3D modes or weather display. • Select radar range on the radar display.
Drag		Change 3D viewing point.
Tap		Do the function assigned to [Two Finger Tap Function], which is in the ([Settings]→[General]) menu. See section 1.16.
Long tap		Do the function assigned to [Two Finger Long Tap Function], which is in the ([Settings]→[General]) menu. See section 1.16.

1. SYSTEM INTRODUCTION

Notes on touchscreen operations

- Waterdrops on the screen can cause mis-operation and slow touch response. Wipe the screen with a dry cloth to remove the water.
- This equipment uses a capacitive touch screen. Tap the screen with your fingertips directly. Do not use sharp objects (needle, pen, nail) or a stylus pen. Be careful not to scratch the screen.
- Touchscreen may be reduced when wearing gloves.
- Do not put objects (adhesive-backed paper, etc.) on the screen. Mis-operation can result.
- Keep the equipment away from radio antennas, fluorescent lights, solenoid valves and electronic devices to prevent unintended operation caused by electrical noise.
- The front panel is made of glass. If the front panel is damaged, do not try to repair it yourself. Unauthorized repair will void the warranty. Contact your dealer about repair or replacement.
- The touch screen can be locked to prevent operation of the equipment. See the procedure below.

How to lock the touch screen

The touch screen can be locked to prevent unintentional operation.

With the power applied, press  to show the [Quick Access] window. Tap the [Touch Screen] icon.

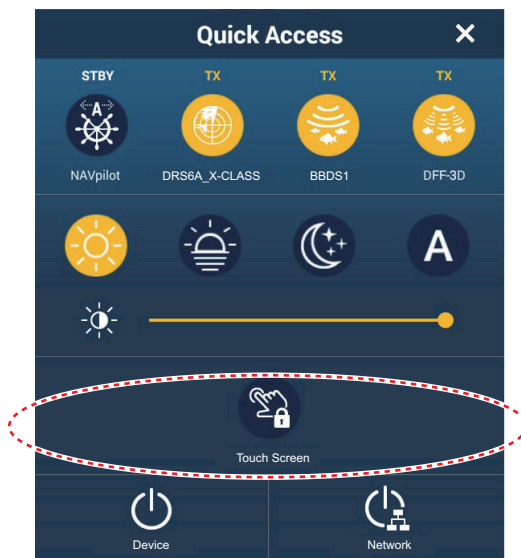

When the screen is locked, a small padlock-shaped icon appears at the [Home] button position, at the top-left of the screen, as shown in the figure below.



Locked







Unlocked

1.2 Remote Control Units (option)

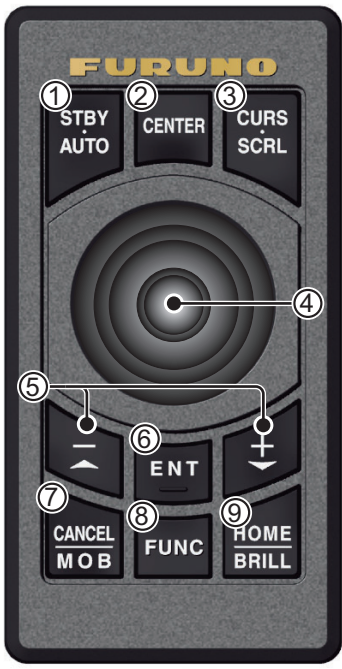
The Remote Control Units let you operate the system without touching the screen. When the power is applied and a Remote Control Unit is connected, an orange cursor (selection cursor) marks current selection in menus.

1.2.1 Remote Control MCU-002

No.	Key	Function	
	1	STBY•AUTO key	Switches the steering mode of the FURUNO NAVpilot series Autopilot between the Stand-by and AUTO modes. When switching occurs, a beep sounds* and a message informs you of Navpilot mode change. <ul style="list-style-type: none"> • Stand-by mode→AUTO mode: "Navpilot Engaged". • AUTO mode→Stand-by mode: "Navpilot Disengaged".
	2	CENTER key	<ul style="list-style-type: none"> • Returns own ship to the center of the screen (Chart Plotter/Weather/Radar display). • Cancels the echo history (Fish finder display).
	3	CURS•SCRL key	Switches the joystick gesture between the cursor mode and scroll mode.
	4	Joystick	<p>Short push: Works the same as tap gesture.</p> <ul style="list-style-type: none"> • Opens the pop-up menu. • Activates the item selected by the cursor. <p>Long push: Works the same as long tap gesture.</p> <ul style="list-style-type: none"> • Enables editing of display icons. <p><u>Joystick operation:</u></p> <p>Cursor mode operation:</p> <ul style="list-style-type: none"> • Moves the cursor. <p>Scroll mode operation:</p> <ul style="list-style-type: none"> • Pans the display (Chart Plotter/Weather/Radar display). • Shifts the range and scrolls back the picture (Fish finder display).

No.	Key	Function
5	+, - key	<ul style="list-style-type: none"> • Selects an item from the Slide-out/main/pop-up menu. • Zooms in (+) and out (-).
6	ENT key	<ul style="list-style-type: none"> • Activates selected item. • Press ENT key followed by joystick operation: Opens the Layers menu, Quick Page, Slide-out menu, Data Area. <div style="display: flex; justify-content: space-around; margin-top: 10px;"> <div style="text-align: center;"> <p>•Opens Layers menu</p>  </div> <div style="text-align: center;"> <p>•Opens Quick Page</p>  </div> </div> <div style="display: flex; justify-content: space-around; margin-top: 10px;"> <div style="text-align: center;"> <p>•Opens Slide-out</p>  </div> <div style="text-align: center;"> <p>•Opens Data Area</p>  </div> </div>

1. SYSTEM INTRODUCTION

No.	Key	Function
7	CANCEL/MOB key	Short push: <ul style="list-style-type: none"> Closes the menu or dialog box. Stops the aural alarm. Ends the tool mode (End Route, End Move, etc.). Long push: <ul style="list-style-type: none"> Enters the MOB mark (at the own ship's position).
8	FUNC key	<ul style="list-style-type: none"> Short push: Does the task assigned to the "two finger tap function" Long push: Does the task assigned to the "two finger long tap function"
9	HOME/BRILL key	Short push: Shows the Home screen. Long push: Opens the [Quick Access] window.

* The beep sound can be turned on or off with [Notify when NAVpilot is engaged] in the menu. See section 2.10.8.

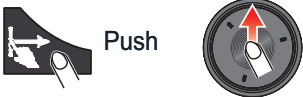
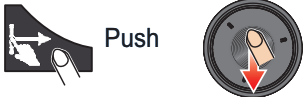
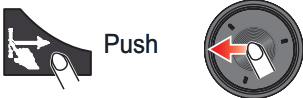
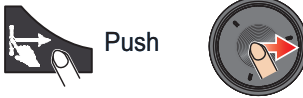

1.2.2 Remote Control Unit MCU-004

	No.	Key	Function
	1	STBY•AUTO key	Switches the steering mode of the FURUNO NAVpilot series Autopilot between the Stand-by and AUTO modes. When switching occurs, a beep sounds* and a message informs you of Navpilot mode change. <ul style="list-style-type: none"> Stand-by mode→AUTO mode: "Navpilot Engaged". AUTO mode→Stand-by mode: "Navpilot Disengaged".
	2	HOME/BRILL key	<ul style="list-style-type: none"> Short push: Opens the Home screen. Long push: Opens the Brilliance/Power window.
	3	CONTROL key	Switches between displays that can be controlled with the MCU-004 when multiple displays are installed in the same network.
	4	FUNC key	<ul style="list-style-type: none"> Short push: Performs the task assigned to the "two finger tap function" Long push: Performs the task assigned to the "two finger long tap function"
	5	CURS•SCRL key	Switches the function of the joystick between the Cursor and Scroll modes.
	6	CENTER key	<ul style="list-style-type: none"> Returns own ship to center of screen (Chart Plotter/Weather/Radar display). Cancels the echo history (Fish finder display).
	7	Rotary knob	<ul style="list-style-type: none"> Selects an item from the [Slide] menu, [Settings] menu, pop-up menu. Zooms in/out.

No.	Key	Function
8	Joystick	<p>Short push: Works same as tap gesture.</p> <ul style="list-style-type: none"> • Opens the pop-up menu. • Activates the item selected by the cursor. <p>Long push: Works same as long tap gesture.</p> <ul style="list-style-type: none"> • Enables editing of display icons. <p><u>Joystick operation:</u></p> <p>Cursor mode operation: Moves the cursor.</p> <p>Scroll mode operation:</p> <ul style="list-style-type: none"> • Pans the display (Chart Plotter/Weather/Radar display). • Shifts the range and scrolls back the picture (Fish finder display).
9	EDGE key	<ul style="list-style-type: none"> • Activates selected item. • Press ENT key followed by joystick operation: Opens Layers menu, Quick Page, Slide-out menu, Data Area. <div style="display: flex; justify-content: space-around; align-items: flex-start;"> <div style="text-align: center;"> <p>• Opens Layers menu</p>  <p>Push</p> </div> <div style="text-align: center;"> <p>• Opens Quick Page</p>  <p>Push</p> </div> </div> <div style="display: flex; justify-content: space-around; align-items: flex-start; margin-top: 10px;"> <div style="text-align: center;"> <p>• Opens Slide-out menu</p>  <p>Push</p> </div> <div style="text-align: center;"> <p>• Opens Data Area</p>  <p>Push</p> </div> </div>
10	CANCEL/MOB key	<p>Short push:</p> <ul style="list-style-type: none"> • Closes the menu or dialog box. • Stops the aural alarm. • Ends the tool mode (End Route, End Move, etc.). <p>Long push:</p> <ul style="list-style-type: none"> • Enters the MOB mark (at the own ship's position).

* The beep sound can be turned on or off with [Notify when NAVpilot is engaged] in the menu. See section 2.10.8.

1.2.3 Control Unit MCU-005

No.	Key Name	Description
1	Power lamp	When the power is applied to the MCU-005, the lamp is lit.
2	EVENT key	<ul style="list-style-type: none"> • Short push: Creates an event mark at the boat's location. • Long push: Creates an MOB at the boat's location.
3	GAIN/TX key	<p>Short push: Adjusts the radar gain/AC SEA/AC RAIN or adjust the Fish Finder/Multi-beam Sounder gain.</p> <p>Long push: Toggles between Standby and Transmit for the radar.</p>
4	MENU key	Opens/closes the menu.
5	HOME/BRILL key	<p>Short push: Opens the Home screen.</p> <p>Long push: Opens the [Quick Access] window.</p>
6	CANCEL/MOB key	<p>Short push:</p> <ul style="list-style-type: none"> • Closes menus/windows. • Stops the aural alarm. • Ends the tool mode (End Route, End Move, etc.). <p>Long push:</p> <ul style="list-style-type: none"> • Enters the MOB mark (at the own ship's position).
7	CTRL key	Switches control between multiple displays when more than one display is in the system.
8	EDGE key	<ul style="list-style-type: none"> • Activates the selected item. • Press the EDGE key, then operate the CursorPad or scroll pad to open Layers menu, Quick Page, Slide-out menu, Data Area. <p>• Opens Layers menu</p>  <p>• Opens Quick Page</p>  <p>• Opens Slide-out menu</p>  <p>• Opens Data Area</p> 
9	FUNC key	<p>Short push: Performs the function assigned to two finger tap function.</p> <p>Long push: Performs the function assigned to two finger long tap function.</p>

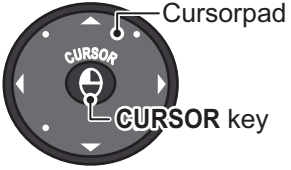
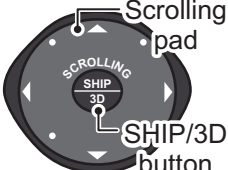
No.	Key Name	Description
10	CURSOR key and cursor pad 	CURSOR key, short push: <ul style="list-style-type: none"> • Opens pop up menus. • Activates/confirms the item selected by the cursor. CURSOR key, long push: <ul style="list-style-type: none"> • Edit display icon (on Home screen). CursorPad operation: <ul style="list-style-type: none"> • Moves the selection cursor.
11	STBY/AUTO key	Switches the steering mode of the FURUNO NAVpilot series Autopilot between the Stand-by and AUTO modes. When switching occurs, a beep sounds* and a message informs you of Navpilot mode change. <ul style="list-style-type: none"> • Stand-by mode→AUTO mode: "Navpilot Engaged". • AUTO mode→Stand-by mode: "Navpilot Disengaged".
12	POINTS/ROUTE key	Short push: Sets the cursor location as a point. Long push: Starts a route from the cursor location.
13	RotoKey™	Short push: <ul style="list-style-type: none"> • Opens pop up menus. • Activates/confirms the item selected by the cursor. Long push: <ul style="list-style-type: none"> • Edit display icon (on Home screen). Rotate: <ul style="list-style-type: none"> • Moves the selection cursor. Selected items are highlighted. • Zooms in/out.
14	RANGE OUT/IN key	<ul style="list-style-type: none"> • Zooms in/out.
15	SHIP/3D key and scrolling pad 	Ship/3D button short push: <ul style="list-style-type: none"> • Returns own ship to center of screen (Chart Plotter/Weather/Radar display). • Cancels the echo history (Fish finder display). Ship/3D button long push: <ul style="list-style-type: none"> • Switches between 2D and 3D display. Scrolling pad: <ul style="list-style-type: none"> • Scrolls chart, radar picture, and AXIS make PTZ network cameras.

* The beep sound can be turned on or off with [Notify when NAVpilot is engaged] in the menu. See section 2.10.8.

1.2.4 Remote Control Unit group settings

If multiple NavNet TZtouch3 units are installed in the network, you can select the display to show on a unit, using the MCU-004 or MCU-005. Additionally, you can select the order in which to cycle through the displays.

Note: Confirm that there are no duplicate unit nicknames in the network. If a duplicate name is found, change the name on the [Sensor List] ([Initial Setup]→[Sensor List]).

1. From the Home screen, tap [Settings]→[Initial Setup].
2. Tap [Remote Controller Configuration] twice.

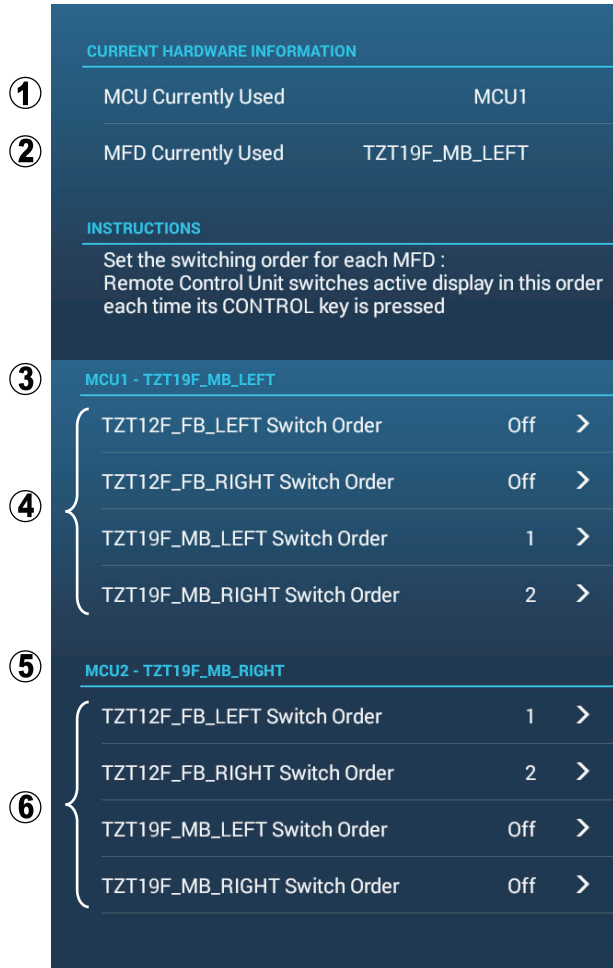

Example remote configuration - MCU-004

No.	Description
1	The nickname automatically assigned to the MCU-004/MCU-005.
2	The nickname assigned to the NavNet TZtouch3 unit currently being operated.
3	Setting for the unit connected to TZT12F_FB_LEFT*, controlled by MCU1.
4	Set the cycling order of units controlled by MCU1. To skip a unit, select it to [Off].
5	Setting for the unit connected to TZT19F_MB_LEFT*, controlled by MCU2.
6	Set the cycling order of units controlled by MCU2. To skip a unit, select it to [Off].

*: For the configurations with an MCU-005 connected, the nickname for the MCU-005 appears.

Based on the menu settings shown on the previous page, the installed configuration should look similar to the following image.

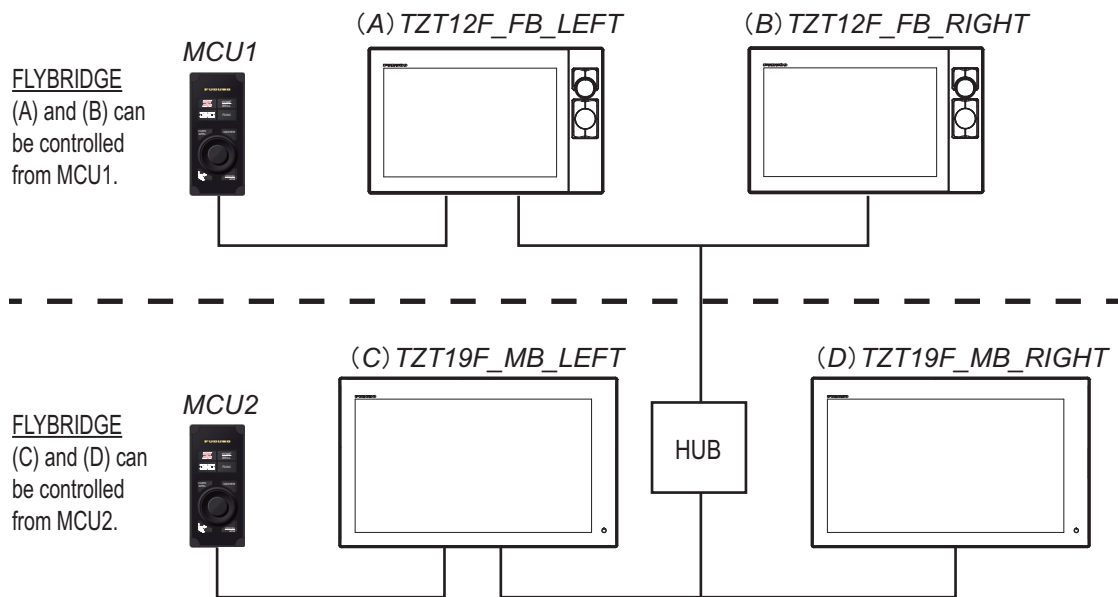

3. Select the displays to cycle.

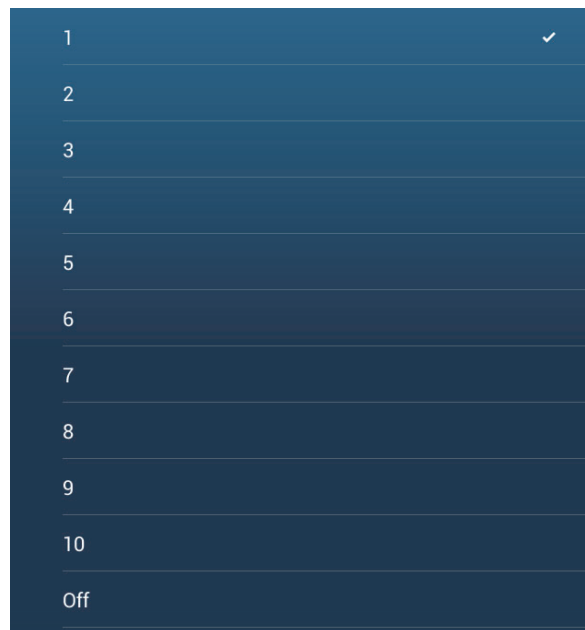

4. Set the order. To skip a display, select it to [Off].
5. Tap "<" on the title bar to return to the [REMOTE CONTROLLER CONFIGURATION] menu.
6. Tap the [Confirm] button on the title bar to save settings and close the menu.

1.3 How to Turn the Power On or Off

How to turn the power on

Tap (push for TZZ9F/12F) the power switch (⏻) on the front panel to turn the power on. The equipment beeps twice and the start-up screen appears. After the startup process is completed, the welcome screen appears, as shown below.

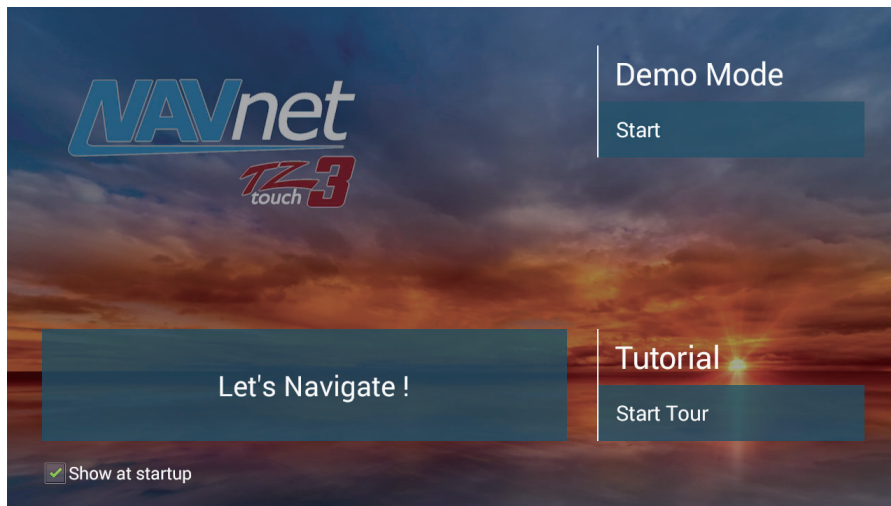
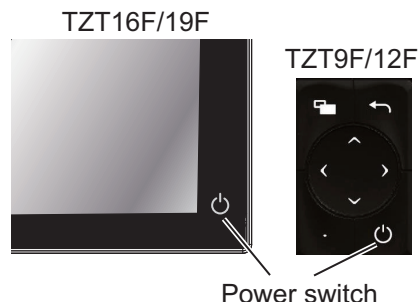

[Demo Mode]: Tap [Start] to start the Demo mode. To stop the Demo mode, go to the Home screen, tap [Settings]→[General]→[Stop Demo].

[Let's Navigate]: Start normal operation. (The equipment starts up with the last-used display.)

[Tutorial]: Tap [Start Tour] to start the tutorial. You can stop the tutorial at any time by tapping the screen. A confirmation message appears; tap [OK] to stop the tutorial.

[Show at startup]: Check to get the welcome screen each time the equipment is powered. Remove the checkmark to hide the welcome screen at power-up. You can also show or hide the welcome screen* from the menu.

After the welcome screen is cleared, the [NAVIGATION WARNING] screen appears. Tap [OK] to confirm the warning, and the [LIMITATIONS ON USE] screen appears. Tap [OK] to confirm the contents.

* To show or hide the welcome screen, go to the Home screen, tap [Settings]→[General], then turn [Show Welcome Screen at startup] on or off.

WARNING - LIMITATIONS ON USE

This product is intended to be used only as an aid to navigation.
The built-in background charts of this product contain a limited version of chart datasets only for general awareness. And also, this detailed chart No. 20202503 is from Japan Hydrographic office.

Datum information: WGS-84

By pressing [ENT] key, you confirm that you acknowledge the above warning and accept the limitations of this product.

OK

How to turn the power off

Tap (push for TZT9F/12F) the power switch to show the [Quick Access] window.

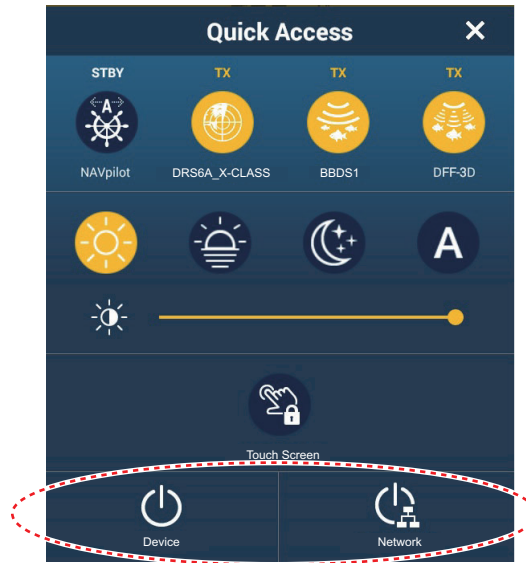

Tap [Device] to power off only this unit, or [Network] to power off this unit and all other NavNet TZtouch3 units in the network. A beep sounds, the message "Shutdown in progress" appears, then the unit shuts down shortly thereafter.

Note 1: If you cannot turn off the power as shown above, or the screen has frozen, push and hold the power switch until the screen goes blank, wait two seconds, then release the switch.

Note 2: Do not turn off the power during the start-up. Wait until the start-up is completed before you turn off the power.

Note 3: The screen refreshes slower in low ambient temperature.

1.4 How to Adjust the Brilliance of the Display and Hue

With the power applied, press  to show the [Quick Access] window.

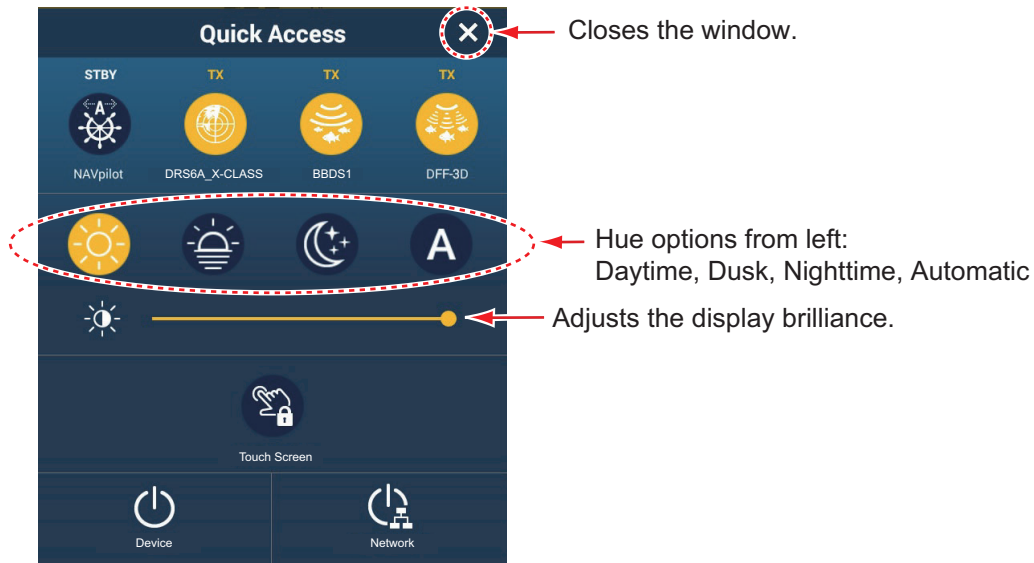

To adjust the brilliance, tap (push for TZT9F/12F) the power switch, drag the icon on the slider bar or tap the slider bar.

To select the hue, tap the applicable icon above the slider bar. The Auto icon automatically adjust the hue according to the time of day at your ship's position.

How to synchronize brilliance of units in the network

Tap [Settings]→[General], then turn on [Brilliance Synchronization] to synchronize the brilliance among NavNet units in the network.

Note: Hue settings are not synchronized.

1.5 Home Screen

The Home screen is where you access functions and menus, select displays, and check sensor status. Tap the [Home] icon at the top left corner to show the Home screen. The Home screen is automatically closed, and the previous operation display restored, when no operation is detected for approx. one minute.

The figure below shows an example display with all sensors and corresponding devices connected.

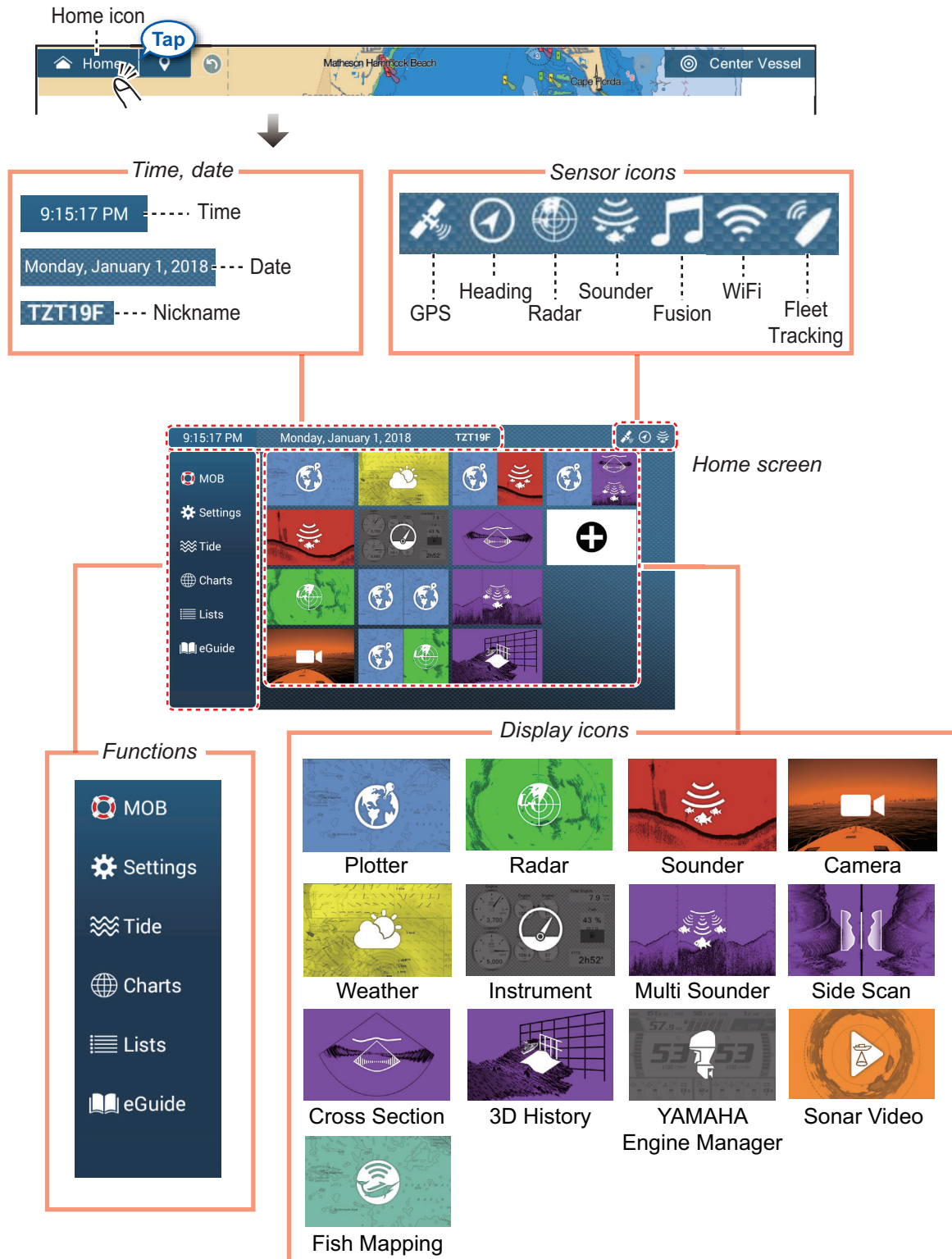

1. SYSTEM INTRODUCTION

Date/Nickname show the date/time and the nickname of your unit. The nickname can be changed. Tap the nickname to show the software keyboard. Change the nickname. See section 1.15 for how to use the keyboard.

The **Sensor icons** show the sensors connected in the system and their status, in the following colors.

White: Sensor normal

Red: Sensor error

Gray: Sensor inactive (stopped)

The **Functions** section provides the features mentioned below. If the item is hidden, drag up or down from [Settings]. ([MOB] is fixed.)

[MOB]: Enters a MOB mark (to mark man overboard location on the chart plotter and radar displays). See section 1.18.

[Settings]: Menus (general, chart plotter, radar, fish finder, etc.) for customization of the system. See section 1.15.

[Tide]: Opens the tide graph.

[Charts]: Displays a list of charts stored in this equipment.

[Lists]: Accesses the lists (points, routes, boundaries, catches, photos, AIS, DSC, ARPA, Alarms).

[FAX30]*: Opens the FAX-30 operation screen.

[Fusion]*: Opens the FUSION operation screen.

[SiriusAudio]*: Opens the SiriusXM Audio control panel.

[eGuide]: Opens the abbreviated operator's manual. You can get the latest version of the operator's manual by accessing the quick response code provided in the introduction section of the guide.

* Requires appropriate equipment. Not shown otherwise.

The **Display icons** select corresponding displays. See the next section for details

How to reset the home screen

You can easily restore the default home screen. On the Home screen, [Settings]→[Initial Setup]→[Home Page]→[Factory Reset]. A message asks if you are sure to restore the default home screen. Tap [OK].

1.6 How to Select a Display

You have two methods from which to select a display, the Home screen and the quick page.

1.6.1 How to select a display from the Home screen

Tap the [Home] icon to show the Home screen. Tap the applicable display icon. (It may be necessary to swipe the screen if you have programmed a number of display icons.)



Note: The display icons can be edited (size changed, layout rearranged, icon deleted, etc.) See section 1.7.2.

1.6.2 How to select a display from the quick page

The quick page lets you change the display from the current display without having to go to the Home screen.

To show the quick page, swipe the top of the screen downward. Tap desired display icon to change the display.

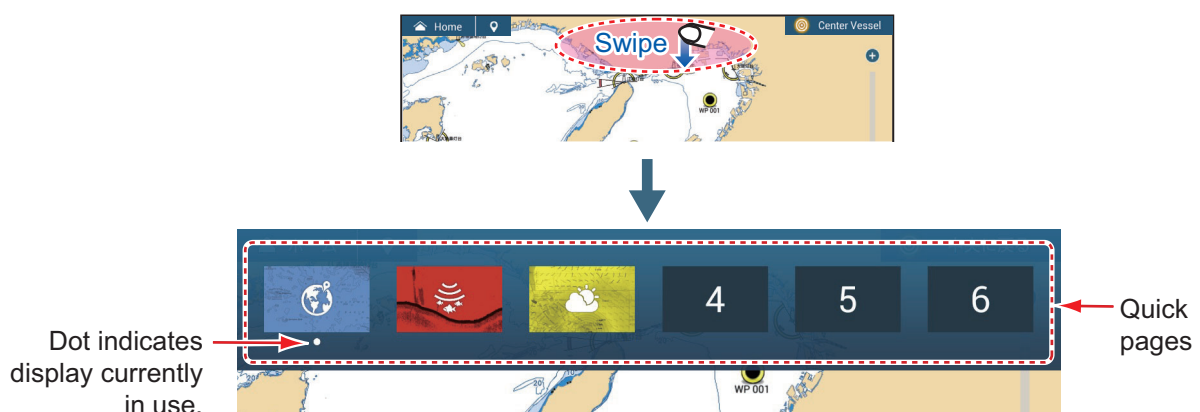

How to add the current display to the quick page

Show the quick page, long tap the desired icon. The icon corresponding to the current mode appears in the quick page.

1.7 How to Edit the Display Icons

The default Home screen arrangement provides display icons in a configuration according to the equipment that you have in your network. If the arrangement does not meet your requirements, you can rearrange the icons to suit your needs. You can have a maximum of 16 display icons, and a screen can be shown in full screen, 2-way, 3-way or 4-way split screens.

Note: Some displays cannot be shown in multi-split screens. An icon is greyed out when it cannot be selected to a multi-split screen. See section 1.7.1.

The displays available depend on the display division selected and your system configuration. The table below outlines the display divisions and available displays.

Display division	Available displays
Full screen	Chart plotter, weather, radar, fish finder, fish mapping, instrument, camera, multi beam sonar, side scan, cross section, 3D history, Yamaha Engine Manager, sonar video
Two-way split	Chart plotter, radar, fish finder, multi beam sonar, side scan
Three-way, four-way split	Chart plotter, radar, fish finder, instrument*, camera*, multi beam sonar, side scan, cross section*, 3D history*, Yamaha Engine Manager, sonar video*

* Not available in left-side screen in a three-way split screen.

1.7.1 How to add a new display icon

1. Tap the [Home] icon to show the Home screen.
2. Tap the + icon, shown right. (If the icon is not shown, this means that all available display icons (16) have been used. Erase an unnecessary icon to make room. See subsection 1.7.2.)
3. Follow the instructions below to create a display icon.

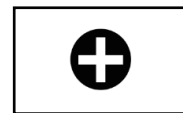

3 Tap to save icon. →

1 Drag display division icon to screen center.

2 Drag display type (icon) to screen center.

Available displays (Unavailable displays are greyed out)
 In the three-way split screen, unavailable displays are denoted by showing “⊘” when dragging the unavailable display (icon).

After saving, the arrangement is then opened on the screen and the display icons on the Home screen are updated according to your arrangement.

1.7.2 How to edit a display icon

Long tap the display icon to edit to show the editing icons on the display icon. Tap the applicable editing icon. Refer to the figure and instructions below.

Note: The chart plotter screen icon, which initially appears at the top left corner of the display screen icons, cannot be deleted or edited, but it can be resized. Other display screen icons can be deleted, edited, resized as desired.

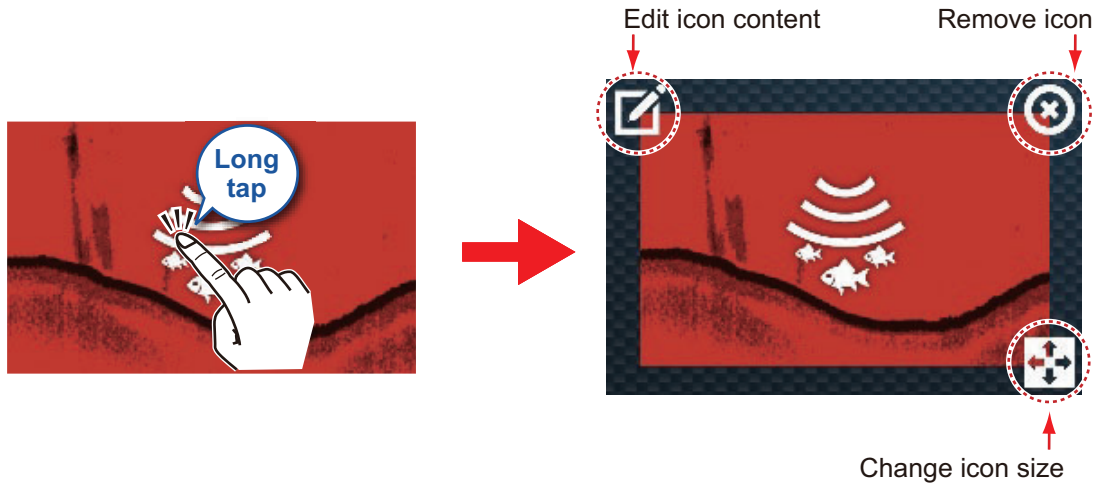

Edit icon content: Tap the icon to show the [EDIT PAGE] display (see subsection 1.7.1). Then, change the configuration as necessary.

Remove icon: Tap the icon to delete the icon from the Home screen.

Change icon size: Tap the icon to switch the size between large and small. Tap anywhere other than an icon to confirm change.

Note: Any changes made on the home screen are reflected on the home screens of other NavNet TZ touch3 in the same network.

1.8 Edge Swipe Functions

This equipment has five edge swipe functions: quick page, Slide-out menu, pop-up menu, Layers menu, and data area (nav data). Swipe or tap the screen at the locations shown below to access those functions.

A window other than the data area is automatically erased from the screen when it is not operated within the time specified. You can specify how long to leave a window open with Home screen→[Settings]→[General]→[User Interface Auto-Hide]. You can erase a window at any time by tapping the screen. To close the Layers menu, tap [X] at the top right corner of the menu.

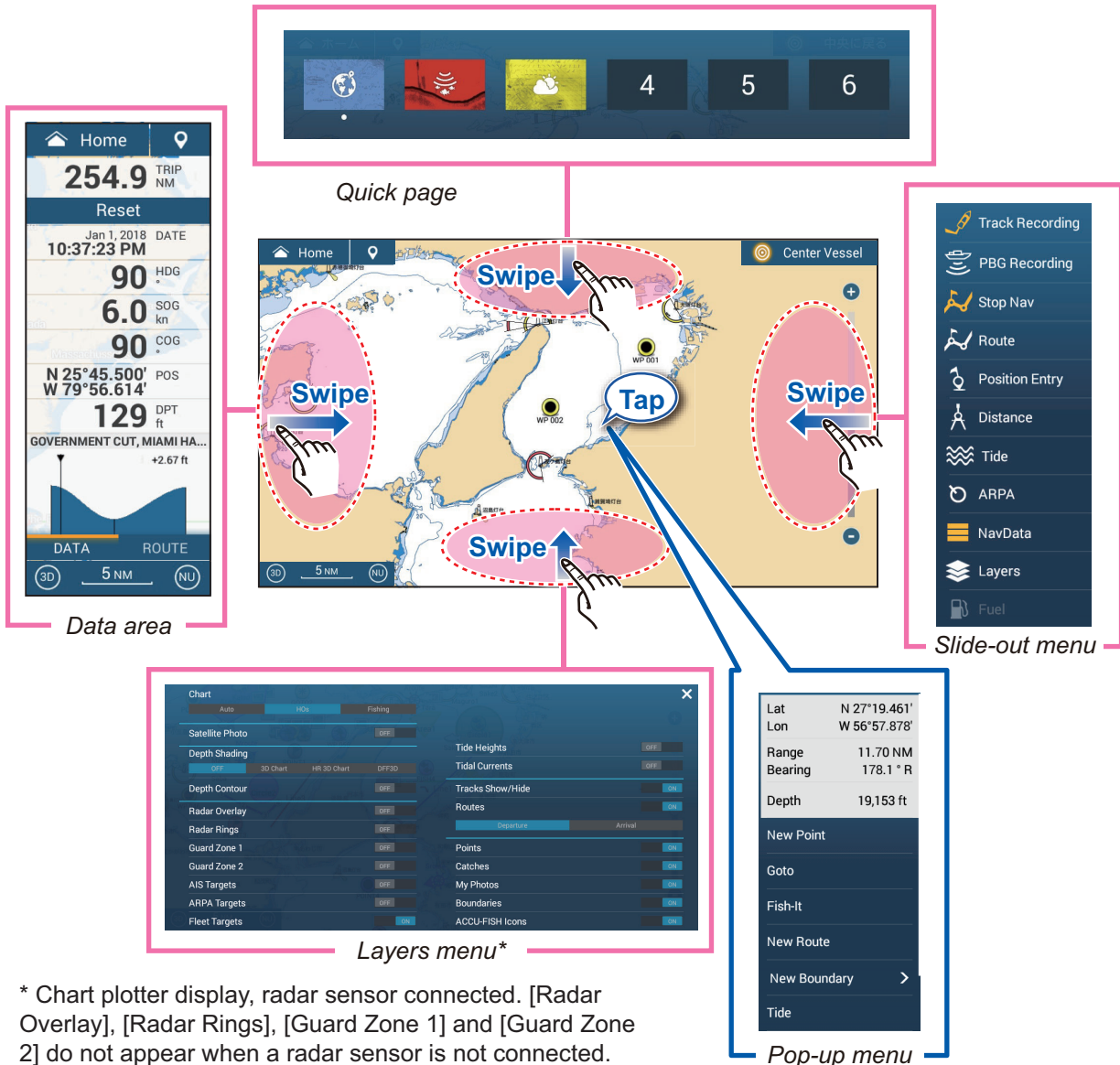

* Chart plotter display, radar sensor connected. [Radar Overlay], [Radar Rings], [Guard Zone 1] and [Guard Zone 2] do not appear when a radar sensor is not connected. Also, [Depth Contours] is shown only when the PBG recording is active.

Function description

The **quick page** selects displays. See subsection 1.6.2.

The **Slide-out menu** provides quick access to several universal functions. To execute a function, tap the function name. Unavailable functions are grayed out. The color of the icon changes according to function status, yellow for ON, white for OFF.

The **pop-up menu** provide a subset of functions that are relevant to the object or location tapped. To execute a function, tap the function name. Unavailable functions are grayed out. Functions that have “>” at the end of their name indicate additional functions are available.

The **Layers menu** provides quick access to the layer options, often-used functions and detailed settings of the active display. Tap a slide switch to turn a function on or off. Unavailable functions are grayed out. This menu can also be accessed from the Slide-out menu in some modes.

Note 1: For the multi-screen display, the active display (orange rectangle circumscribes the active display) can be controlled from the Layers menu.

Note 2: The Layers menu is not available with the instrument displays.

The figure below shows the Layers menu for the radar, fish finder and weather displays.

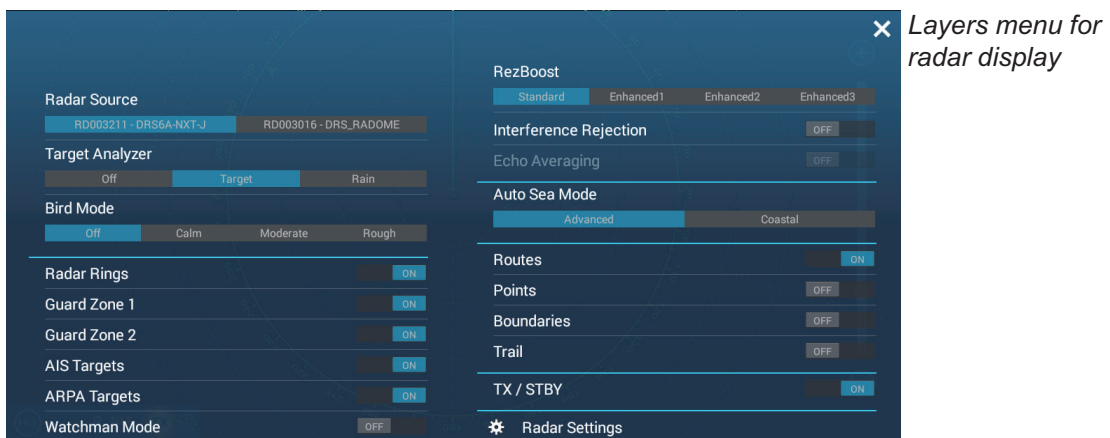

Layers menu for radar display

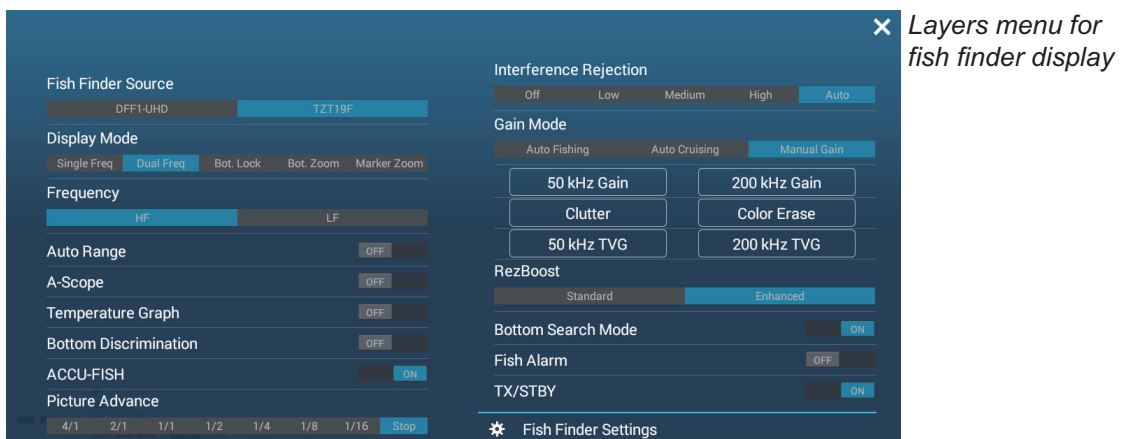

Layers menu for fish finder display

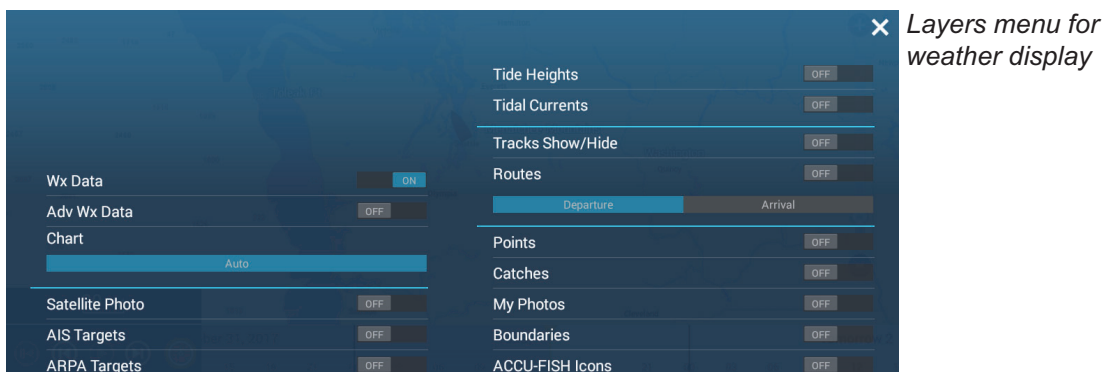

Layers menu for weather display

The **data area** shows navigation data. See the next section for details.

1.9 Data Area

The data area at the left side of the screen shows various navigation, engine, tank and active display sensor data. You can select the data to display, select format (analog or digital) for data and change the order of the data. Data availability depends on your system configuration. The data area configuration is shared among NavNet TZtouch3 units in the same network.

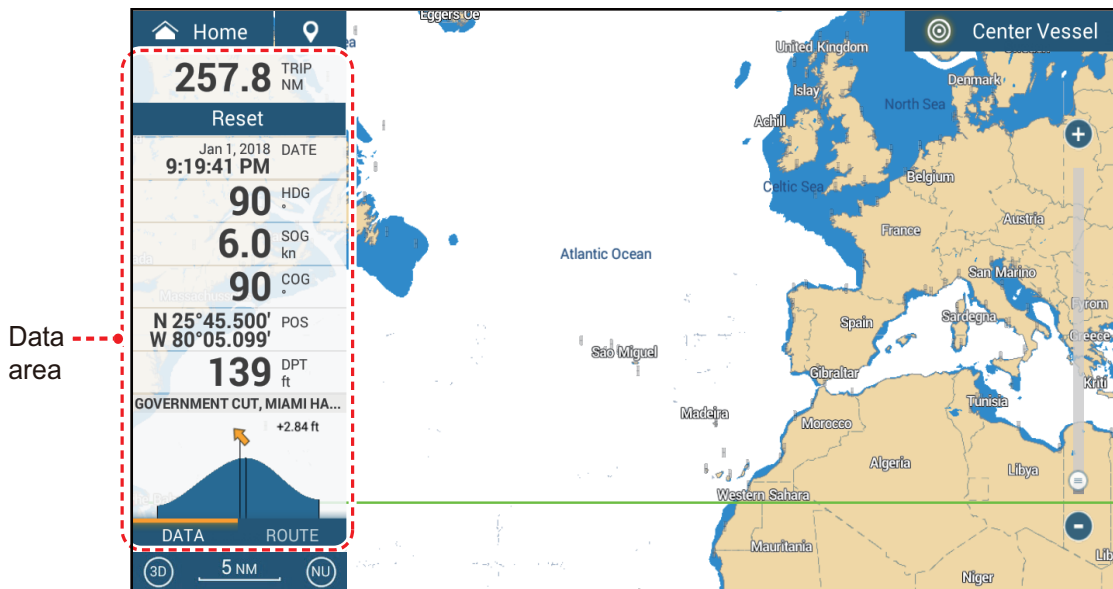

Note: The data display is also available in all split screens, on the left screen.

To show the data area, swipe the screen rightward from the left edge of the screen, or open the Slide-out menu and tap [NavData]. Three yellow bars appear to the left of [NavData] when the data area is displayed. A maximum of two “tabs”* of nav data can be shown in the data area, and the current categories are named at the bottom of the data area. Tap the category name to switch categories. Each category contains numerous data boxes. Hidden data boxes can be shown by scrolling the data area up or down.

* The five sheet categories are

[DATA]: Shown on all display modes.

[ROUTE]: Shown with the chart plotter display.

[RADAR]: Shown with the radar display.

[FISH FINDER]: Shown with the fish finder display.

[DFF-3D]: Shown with the DFF-3D display (multi beam sonar, side scan, cross section, 3D history).

1.9.1 How to change the order of the data

1. Long tap the data area to show the [Edit NavData] display screen.

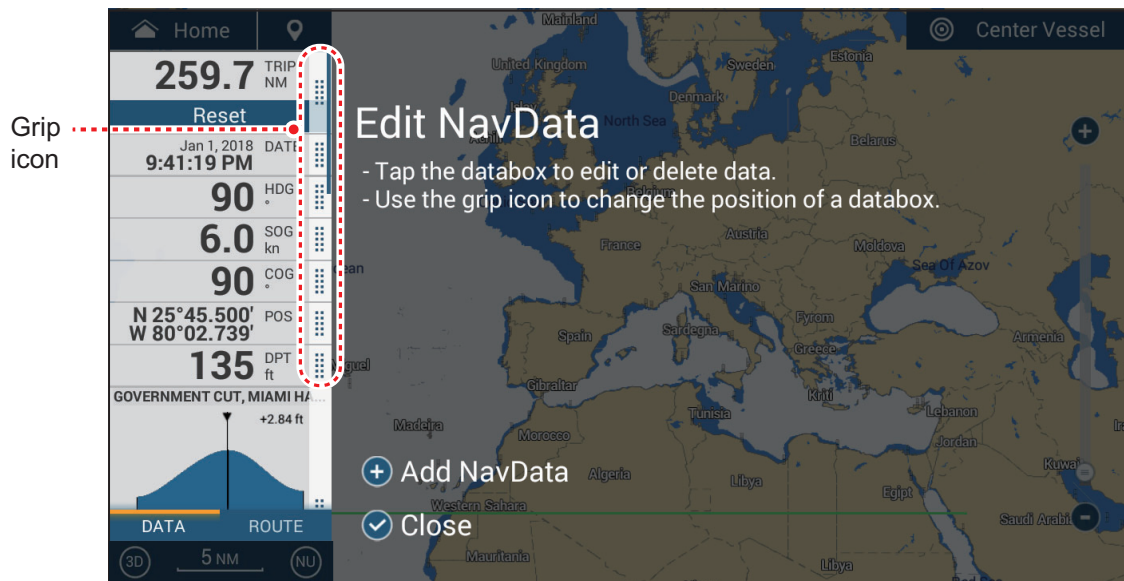

2. Press and hold the grip icon of the data to move, then drag and drop the data box to its new location.
3. Tap [✓] to close the [Edit NavData] display screen.

1.9.2 How to change the contents of a data box

1. Long tap the data area to show the [Edit NavData] display screen.
2. Tap the data box for which you want to change its contents. The [Modify NavData] window appears.

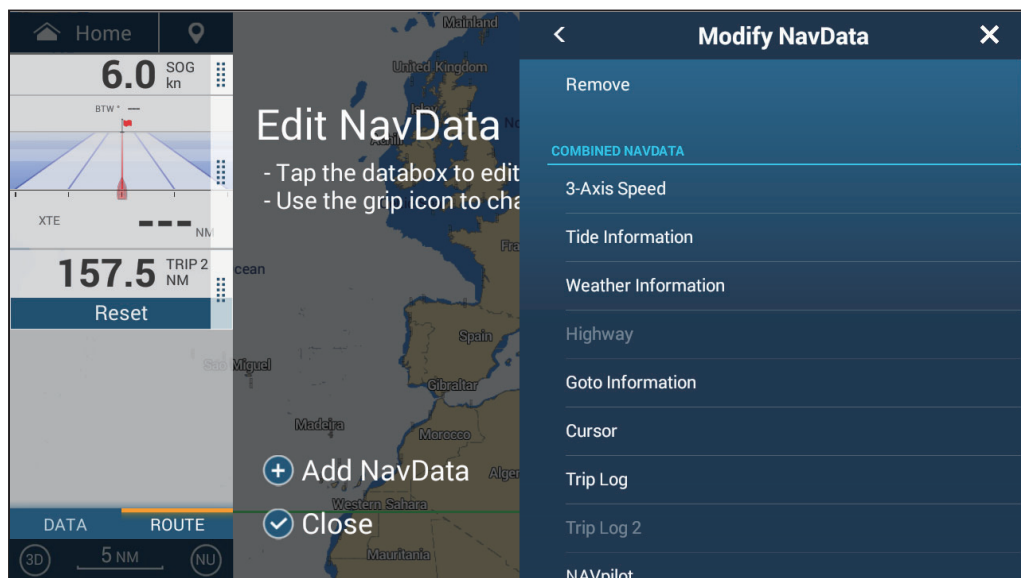

3. In the [Modify NavData] window, tap desired data.
4. Tap [✓] to close the [Edit NavData] display screen.

1. SYSTEM INTRODUCTION

1.9.3 How to add data to a data area

1. Long tap the data area to show the [Edit NavData] display screen.
2. Tap an unoccupied area in the data box to show the [Add NavData] window. You can also show this window by tapping [Add NavData].

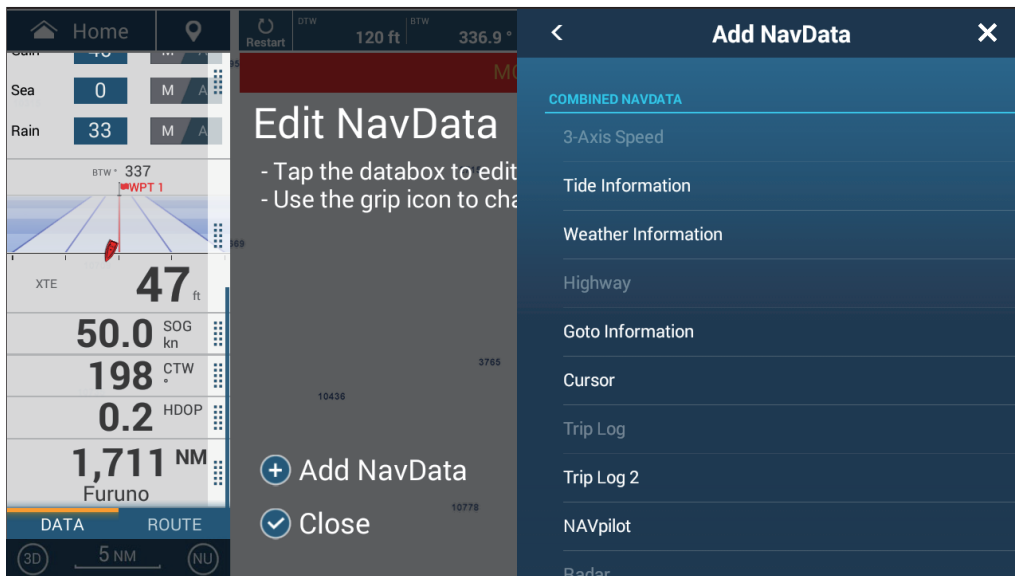

3. In the [Add NavData] window, tap desired data. The selected data appears in the data box. In the example below, the [Cursor Information] box has been added.

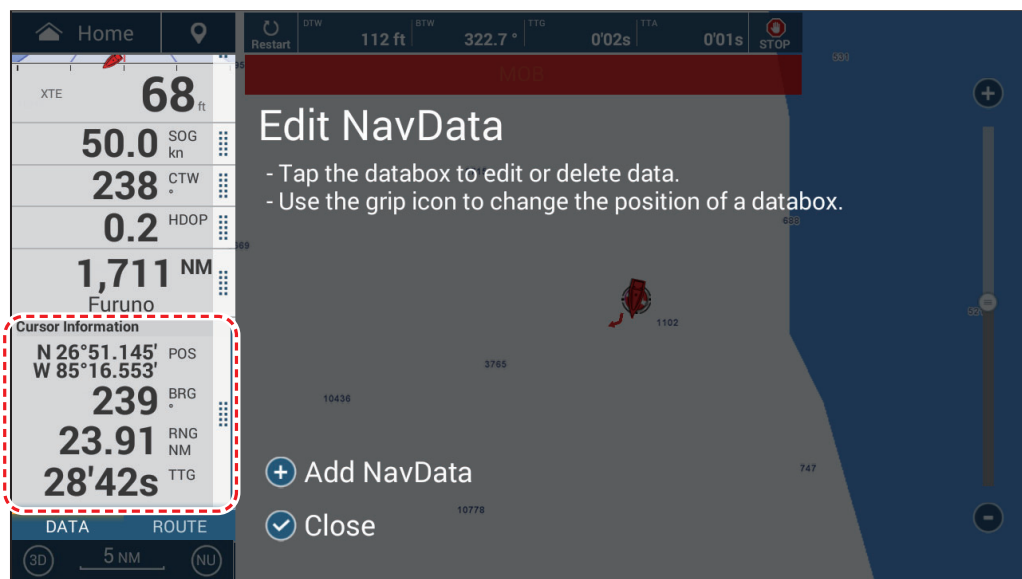

4. Tap [✓] to close the [Edit NavData] display screen.

1.9.4 How to delete a data box

1. Long tap the data area to show the [Edit NavData] display screen.
2. Tap the data box to delete, and the [Modify NavData] window appears.
3. Tap [Remove].
4. Tap [✓] to close the [Edit NavData] display screen.

1.9.5 How to change the display method for the data in a data box

The data in the data boxes can be shown in graphic, numeric, or graph format.

1. Tap the data box to process.
2. At the top of the [Modify NavData] window, tap [Change Type]
3. Tap [Graphic], [Numeric] or [Graph] as appropriate. The figure below shows the appearance of SOG data in the available formats.

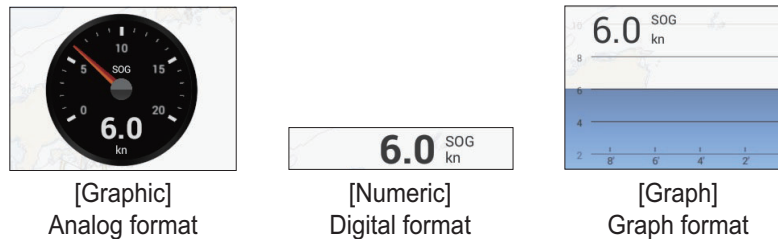

For [Graph], the plotting period (horizontal axis) and plotting range (vertical axis) can be changed.

- 1) Tap the data box to change.
 - 2) Tap [Plot Period]*, then tap desired period, among 1'00s, 5'00s, 10'00s, 30'00s, 1h00, 3h00', 6h00', 12h00', 1d00h, and 2d00h.
* Depending on the display time, the number of data points displayed on the graph may decrease, and the graph may become coarse.
 - 3) Tap [Plot Range Value], and a software keyboard appears. Enter range value, then tap [✓].
 - 4) Tap [×] to close the keyboard.
4. Tap [✓] to close the [Modify NavData] window.

1.9.6 How to adjust the transparency of the data area

1. At the Home screen, tap [Settings]→[Chart Plotter].
2. Tap [NavData Transparency]. Select desired transparency, from 0-80(%).
3. Tap [×] to close the menu.

Note: Alpha blending technology is used for transparency effects.

1.9.7 How to display 3-axis speed from the SC-33/SCX-20

When a SC-33/SCX-20 Satellite Compass™ is connected to the same network, you can use a box in the data area as a dedicated SC-33/SCX-20 display.

Note: This function requires PGN 130578 Vessel Speed Components to be output from the SC-33/SCX-20.

Referring to section 1.9.2 and section 1.9.3, select the 3-Axis Speed display.

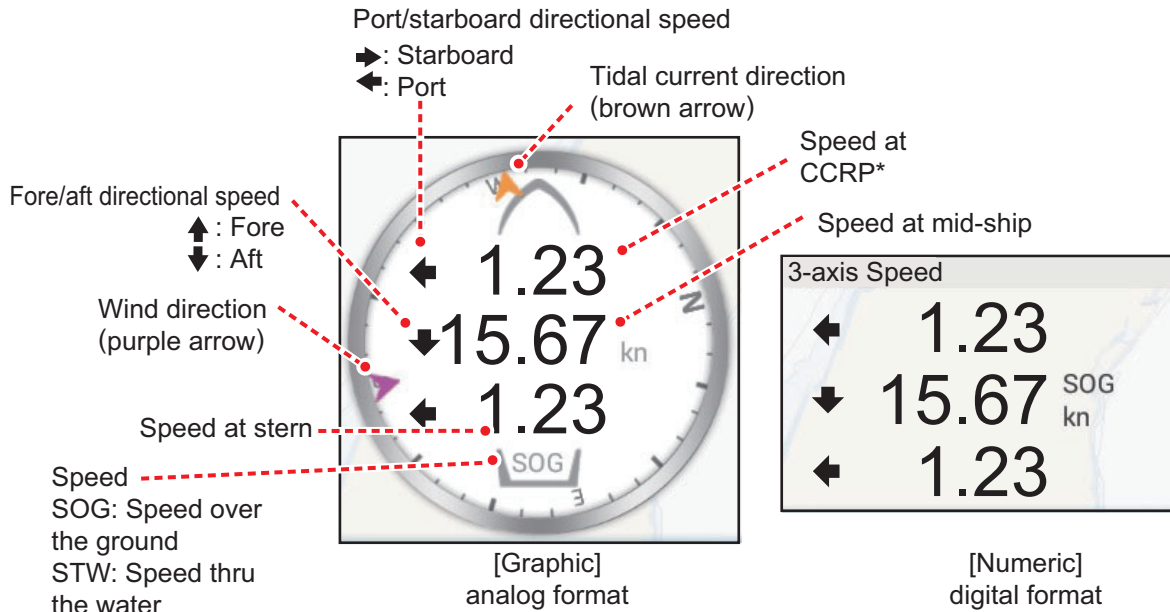

*CCRP (Consistent Common Reference Point) is determined at installation, and is either the bow, transducer location or center of vessel.

1.10 User Interface

You can change the size of some items in the user interface and those items are circumscribed in the figure below. The figure below shows a display example in the [Normal] configuration.

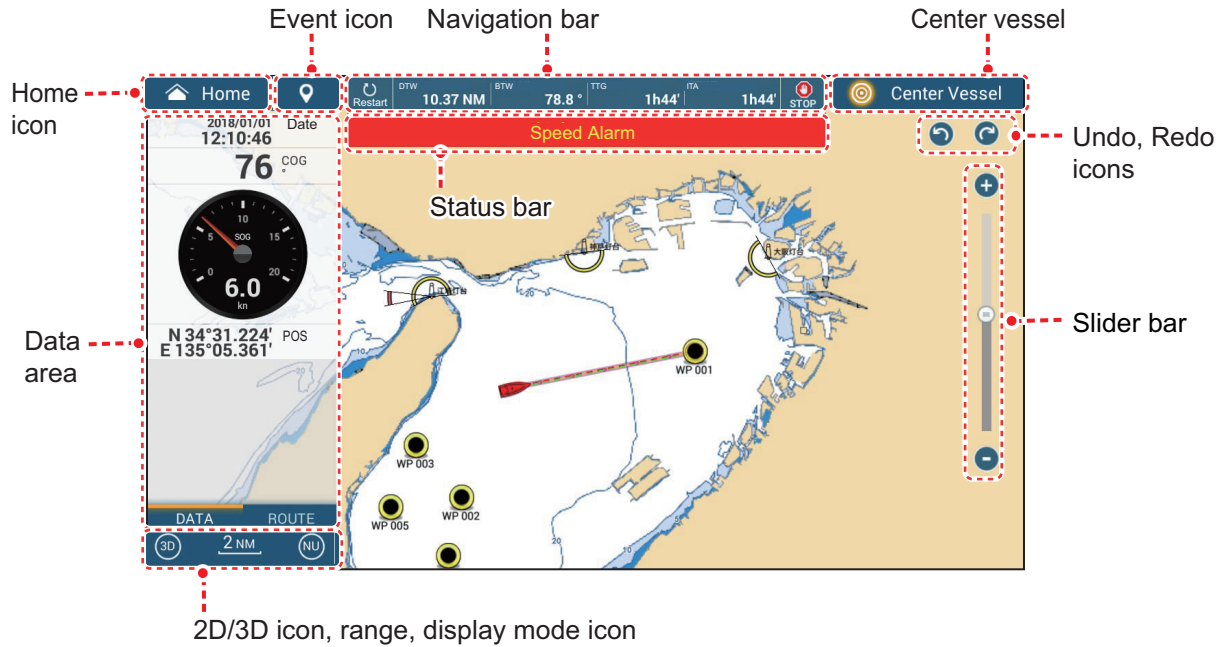

1. From the Home screen, tap [Settings]→[General]→[Scale & Layout].

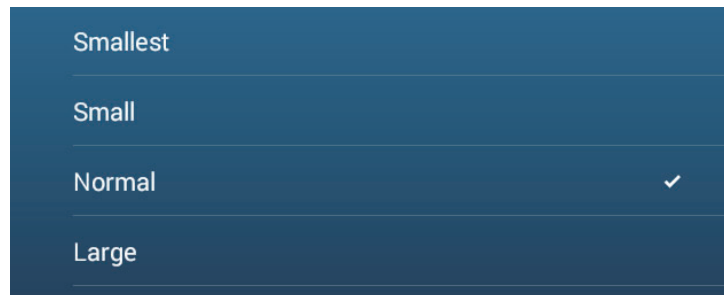

2. Tap desired size.
3. Tap [x] to close the menu.

1.11 MicroSD Cards

This equipment uses microSD cards for chart cards and data storage (tracks, routes, points, boundaries, catches, photos, and setting data). With use of the SDU-001 or a SD card reader, SDXC (Secure Digital Extended Capacity) cards can also be used.

How to insert a microSD card

Before inserting a chart card in the multi function display, turn off the power.

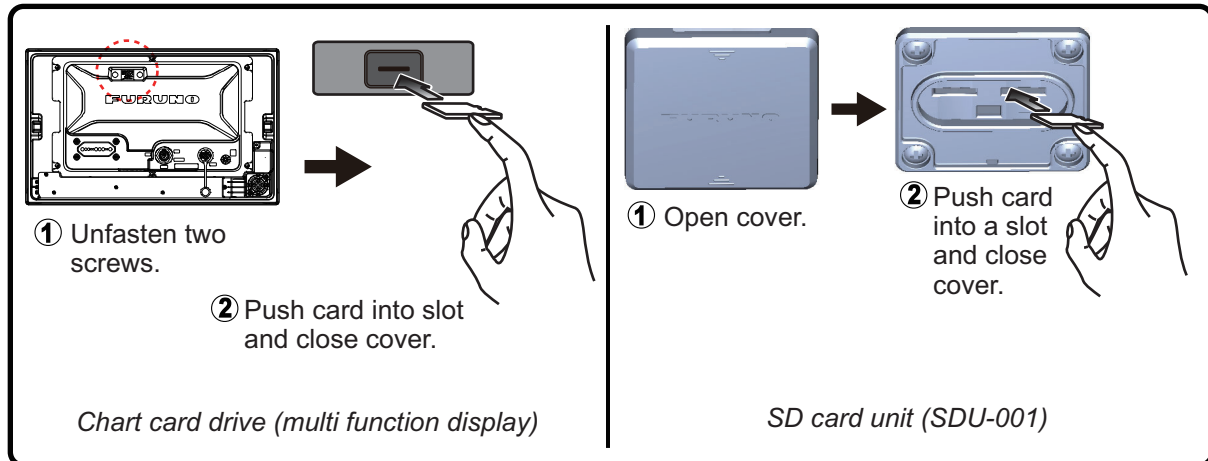

How to format a microSD card/SD card

You do not normally need to format a data microSD card. If the card becomes unreadable, format the card with a formatting program that is compatible with the specifications of the card. Formatting a chart card will erase all chart data on the card.

How to remove a microSD card

- 1) Open the card drive cover.
- 2) Push the card to release the card from the card drive.
- 3) Remove the card with your fingers then close the lid (cover).

About the microSD cards

- Handle the cards carefully. Improper use can damage the card and destroy its contents.
- Make sure the slot lid (cover) is closed at all times.
- Remove a card with only your fingers. Do not use metal instruments (like tweezers) to remove the card.
- Do not remove a card while the device is transferring or accessing information.



Compatible microSD cards

The table below list the cards that have been verified for use with this equipment.

Note 1: The cards were verified using basic functions. All functions were not verified. FURUNO does not guarantee card operations.

Note 2: Cards other than those listed below have not been verified.

Maker	Maker Series	Model	Capacity (GB)
SANDISK	Ultra microSD UHS-I	SDSQUAC-256G-JN3MA	256
		SDSQUAC-128G-JN3MA	128
		SDSQUAC-064G-JN3MA	64
		SDSQUAC-032G-JN3MA	32
		SDSQUAC-016G-JN3MA	16
	High durability MICROSD/ MICROSDXC card	SDSQQND-064G-JN3ID	64
		SDSQQND-032G-JN3ID	32
	micro SDHCcard	SDSDQ-032G-J35U	32
SDSDQ-016G-J35U		16	
TOSHIBA	MU-J series	MU-J256GX	256
		MU-J128GX	128
		MU-J064GX	64
		MU-J032GX	32
		MU-J016GX	16
	MSDAR40M series	MSDAR40N128G	128
		MSDAR40N64G	64
		MSDAR40N32G	32
		MSDAR40N16G	16
		MSDAR40N08G	8
Panasonic	SMGB series	RP-SMGB64GJK	64
		RP-SMGB32GJK	32
		RP-SMGB16GJK	16
	SMGA series	RP-SMGA08GJK	8
		RP-SMGA04GJK	4

1.12 Chart Plotter Introduction

The chart plotter provides a world map in raster format. A vector chart for the US coastline (with Alaska and Hawaii) is also provided. The chart plotter section has functions to enter points, and create and plan routes.

The chart plotter receives position data fed from the built-in GNSS (GPS) receiver (TZT9F/12F/16F) or, in the case of the TZT19F, an external GNSS (GPS) receiver. Your position is marked on the screen with the own ship icon.

The points and routes you have entered are shown on the screen. You can move, delete and edit the points and routes from their pop-up menus.

The chart plotter also does the following functions:

- Plots the track of your ship
- Measures distances and bearings
- Marks man overboard (MOB) position
- Controls alarm functions
- Follows routes

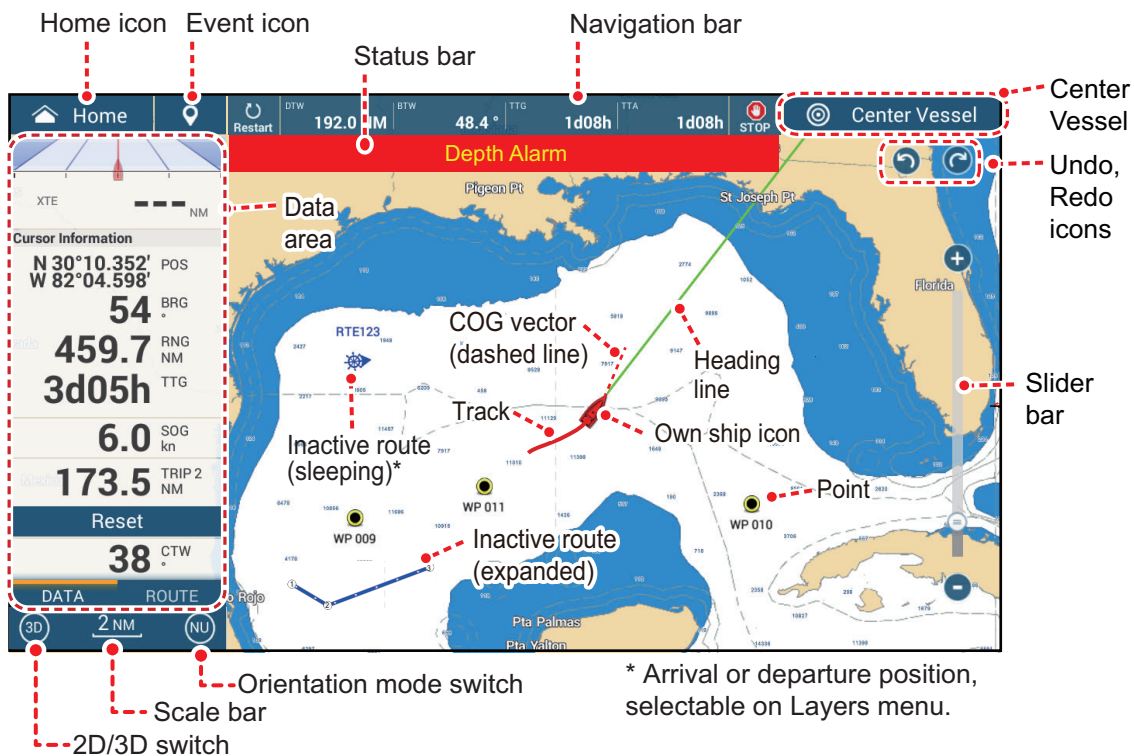

The **status bar**, common to all modes, alerts you to equipment status. The color of both the bar and the status message change according to message category.

- **Red bar, yellow characters:** warning (alarm violation, equipment error, etc.)
- **Yellow bar, black characters:** caution (system message, etc.)

When an alert condition occurs, the equipment beeps (if enabled to do so), the name of the alert appears in the bar, and the bar flashes. You can stop the flashing and silence the beep by tapping the bar. The alert indication remains in the status bar until the cause for the alert is removed.

The **undo/redo icon** has the following functions with points and routes.

- Undo icon: Reverse the last change done.
- Redo icon: Restore the undo action.

1.13 Radar Introduction

A radar system operates in the microwave part of the radio frequency (RF) range. The radar detects the position and movement of objects. Objects are shown on the radar display at their measured distances and bearings in intensities according to echo strength.

A guard zone tells you when the radar targets are in the area you specify.

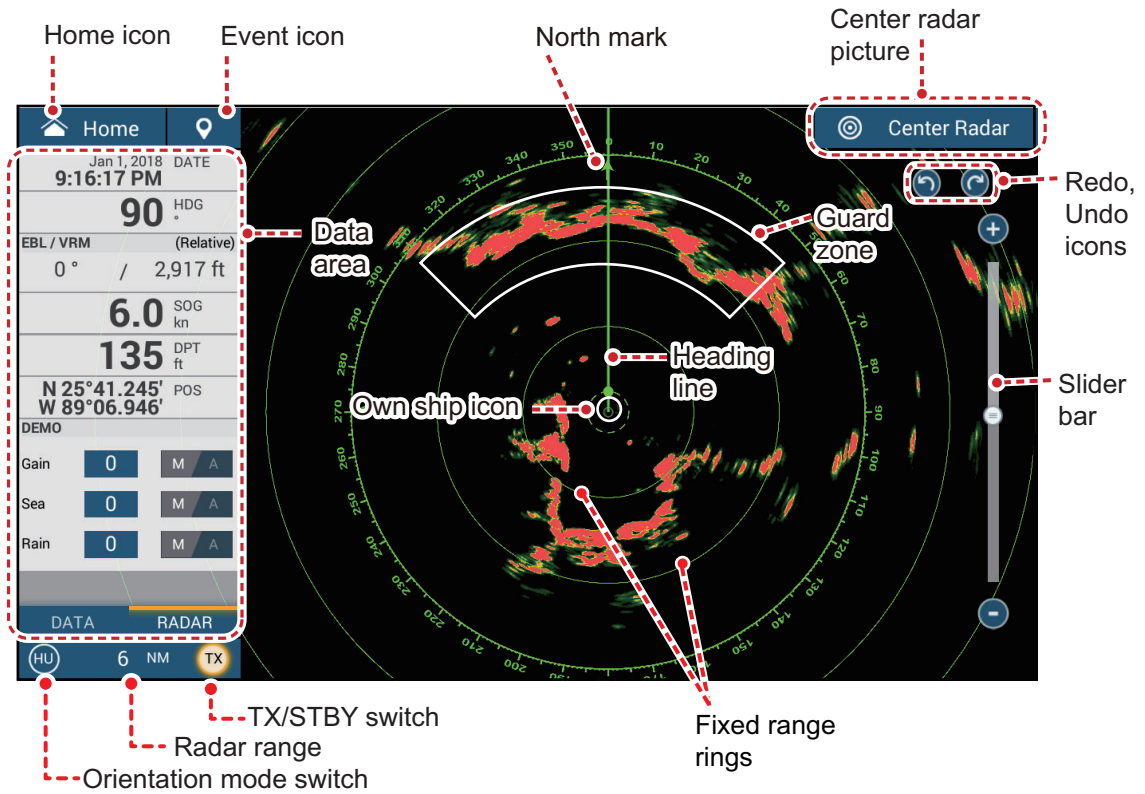

1.14 Sounder (Fish Finder) Introduction

The sounder display provides a picture of the echoes found by the fish finder. Echoes are scrolled across the screen from the right position to the left position.

The echoes at the right position are the current echoes. These echoes can be from separate fish, a school of fish, or the bottom. Depth to the bottom is indicated, provided the gain is set correctly. You can scroll the echoes backward.

Both low and high TX frequencies are provided. (Frequencies depend on the transducer connected.) The low frequency has a wide detection area, which is for general detection and understanding bottom conditions. The high frequency has a narrow beam that helps you inspect fish.

The range, gain, clutter and TVG can be adjusted automatically according to your purpose (cruising or fishing) to let you do other tasks.

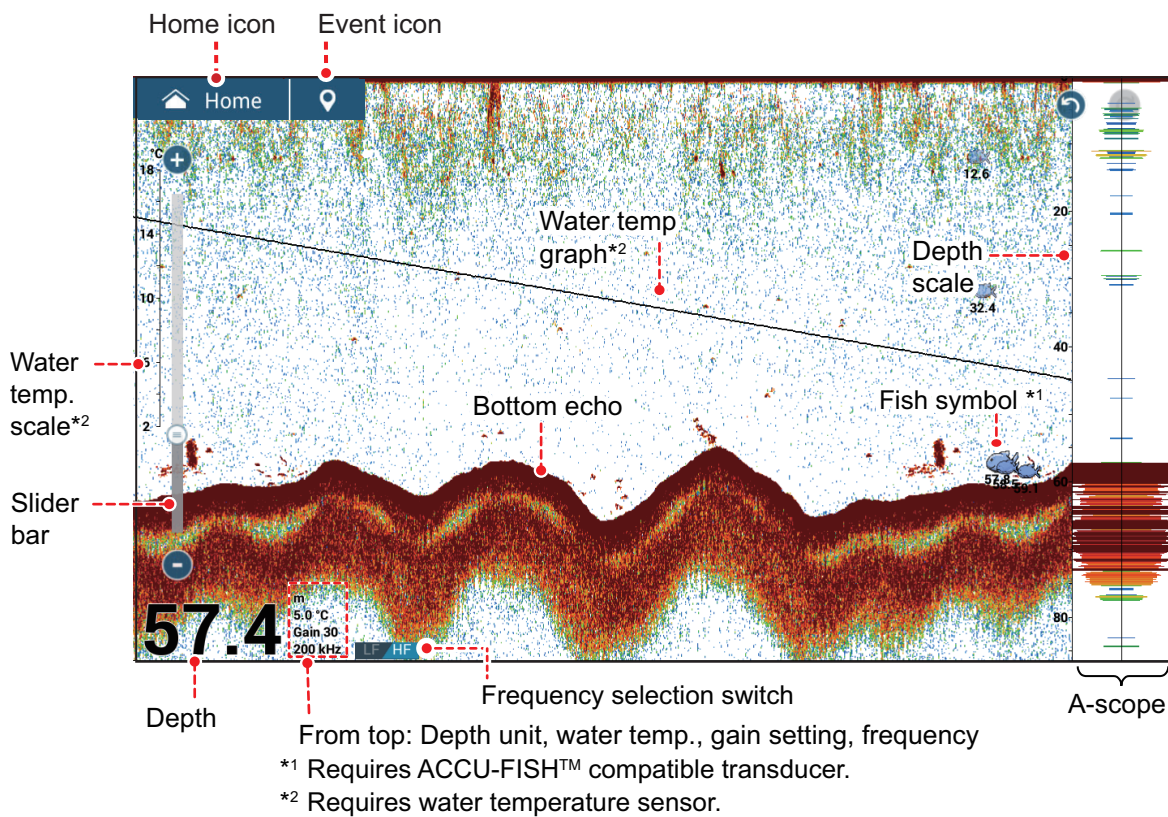

A CHIRP or standard (CW narrowband) type transducer can be connected to this unit. TruEcho CHIRP™ is a revolutionary technology that displays high-resolution, low-noise images using broadband ultrasound and advanced signal processing. The reaction of bottom and reef schools of fish and the seabed echo are displayed distinctly, which is useful for suitable catch determination. For the model of CHIRP transducer, refer to the configuration table in the equipment manual.

1.15 Settings Menu

The [Settings] menu provides the options for customizing your system. The [Settings] menu, as well as all other items on the Home screen, is automatically closed, and the previous operation display restored, when no operation is detected for approx. one minute.

1. Tap the [Home] icon to go to the Home screen.
2. Tap [Settings].

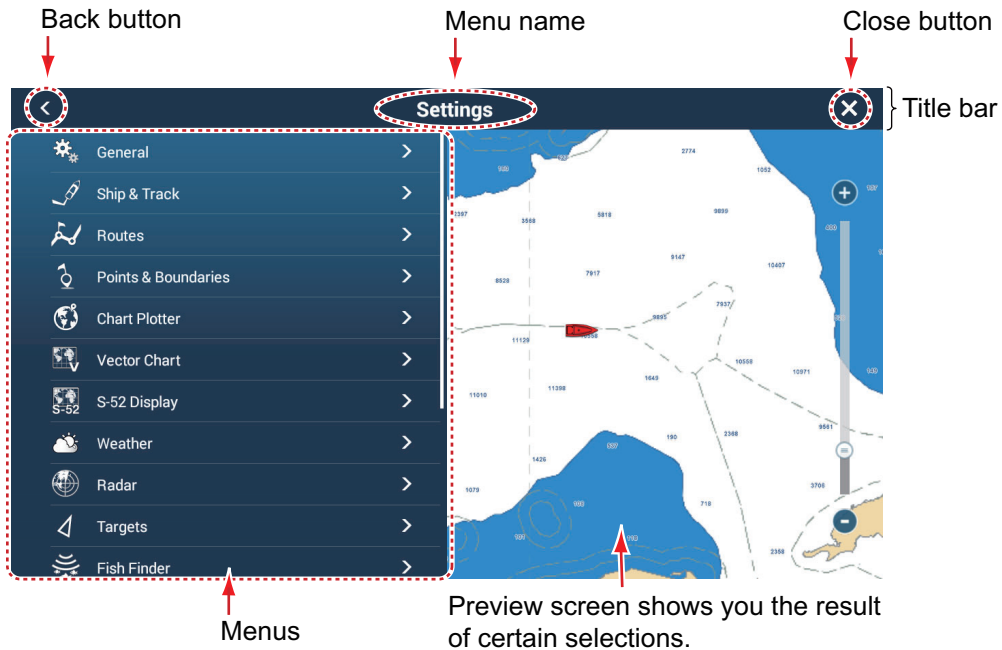

3. Tap a menu. For example, tap the [General] menu.
4. Do one of the following according to the menu item:
 - **ON/OFF flipswitch:** Tap the flipswitch to switch between [ON] and [OFF].



- **Slider bar, keyboard:** Set level by dragging the slider button, or tapping the keyboard icon () to enter the level with the numeric software keyboard. (See the next page for the appearance of the numeric keyboard.)

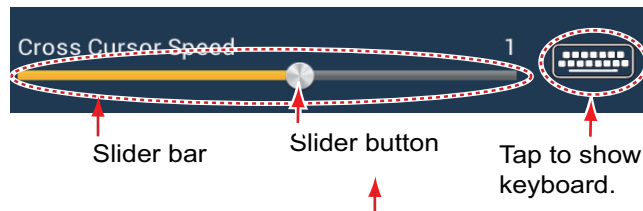

1. SYSTEM INTRODUCTION

- **Alphabet, numerical data entry:** A menu item that requires entry of alphabet and/or numerical data has a keyboard icon (📄). Tap the keyboard icon to show the keyboard. (The keyboard displayed depends on the item selected. Some items provide only the numeric keyboard.) Enter data, then tap [✓] to confirm.

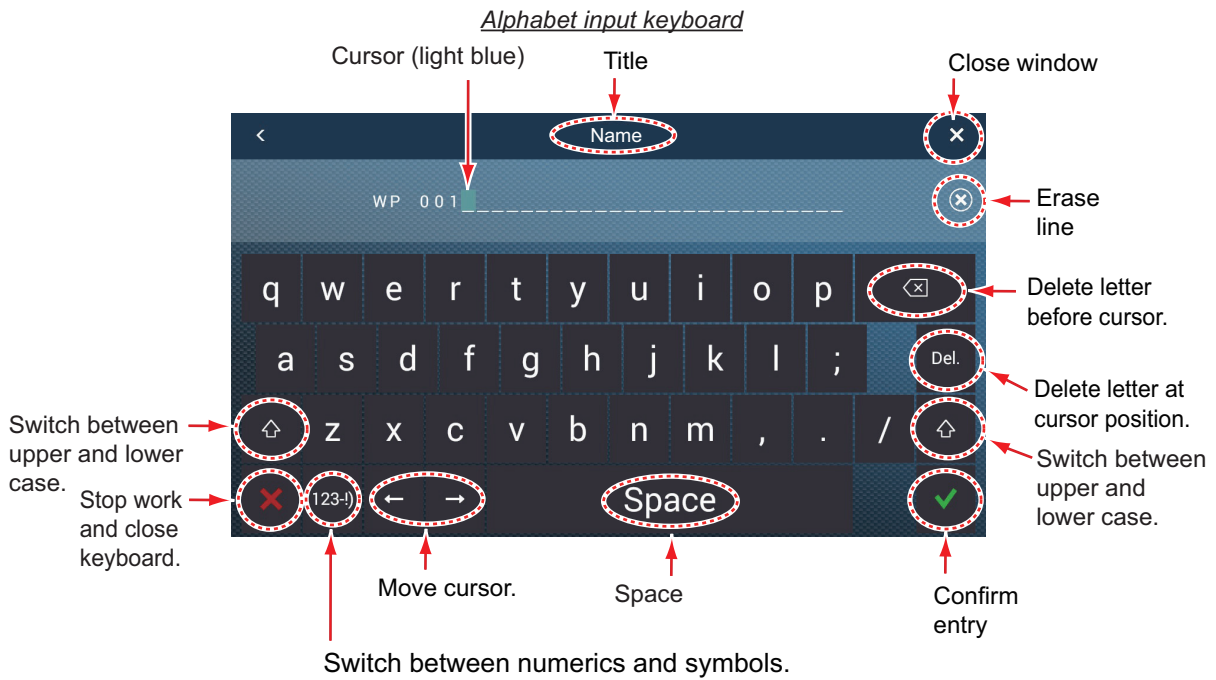

*
 ⬇️ : Lower case input. Tap to switch to upper case input.
 ⬆️ : Upper case input. Tap to switch to lowercase input.
 ⬆️ : Upper case input. Tap to switch to lowercase input.



- **Color selection:** A menu item that requires selection of color shows the current color selection to the right of the name of the menu item. Tap the menu item to

show the color options. Tap color option desired. Current selection is highlighted with a light blue square.

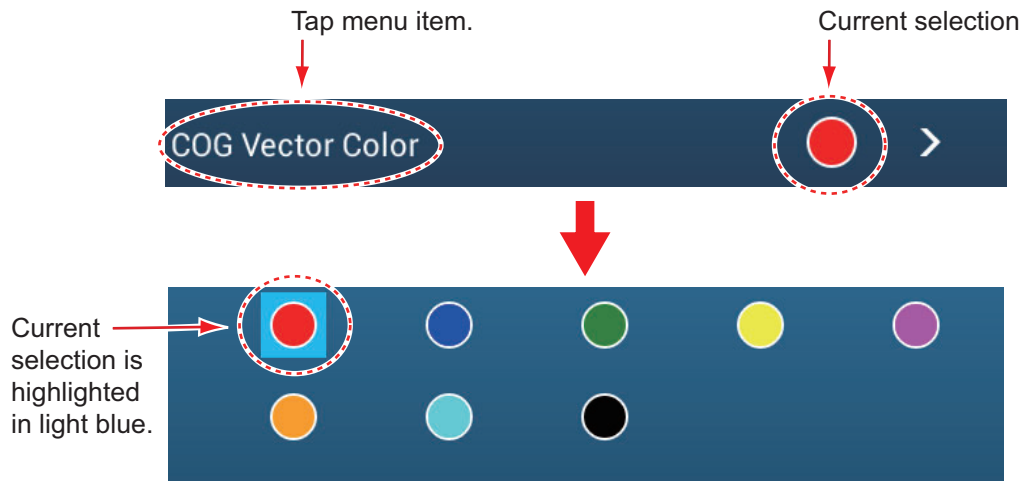

- **Option selection:** A menu item that requires selection of an option shows the current selection on the menu. Tap the option desired. The current selection has a checkmark.

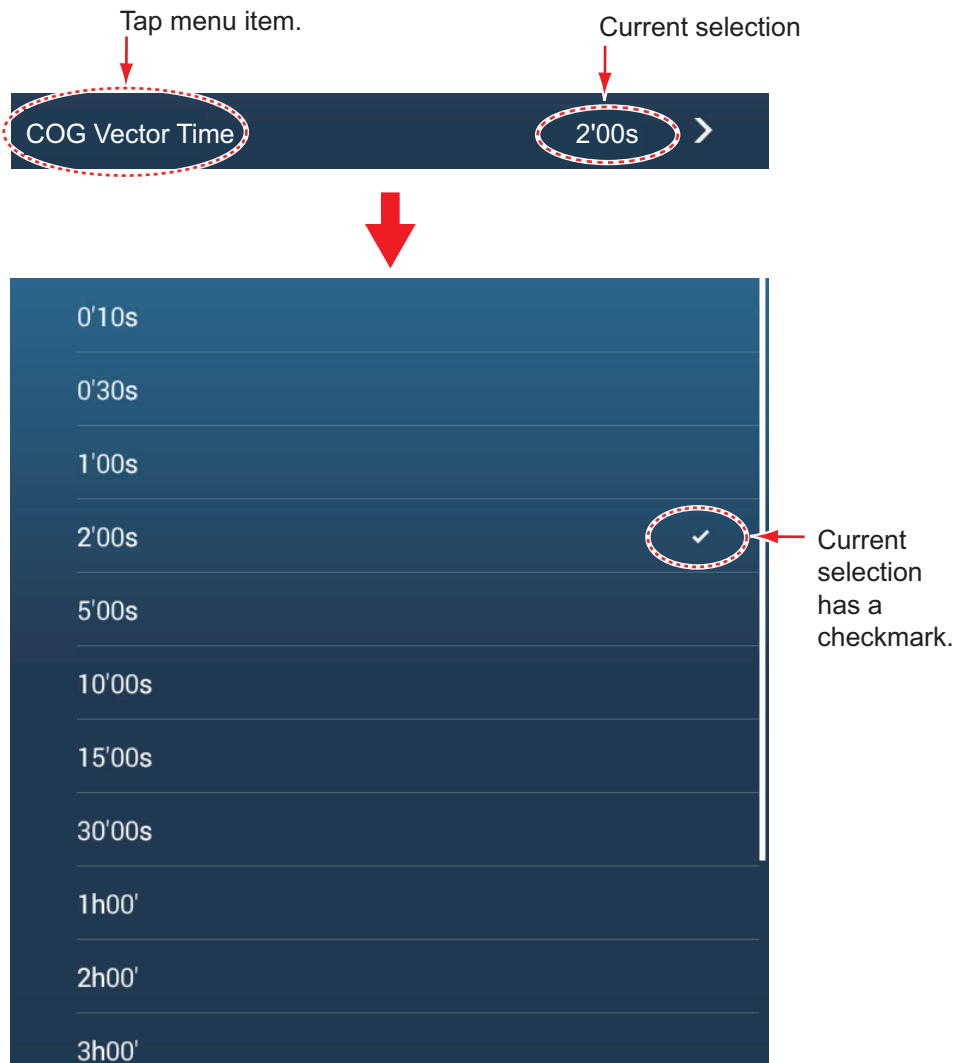

5. Tap the close button on the title bar to finish.

1.16 Two-Finger Tap Function

The two-finger tap function provides a shortcut to commonly used functions. You can program two shortcuts, and access them with short or long two-finger taps. For the TZT9F/12F, this function can also be carried out with the **FUNC** key.

Note: When [Touch Output] (see section 10.5) is enabled, the two-finger tap function is not available on the display that shows the output from the HDMI port. (The display is specified with the camera icon on the Home screen.)

1. Go to the Home screen, then tap [Settings]→[General]→[Two Finger Tap Function] or [Two Finger Long Tap Function].

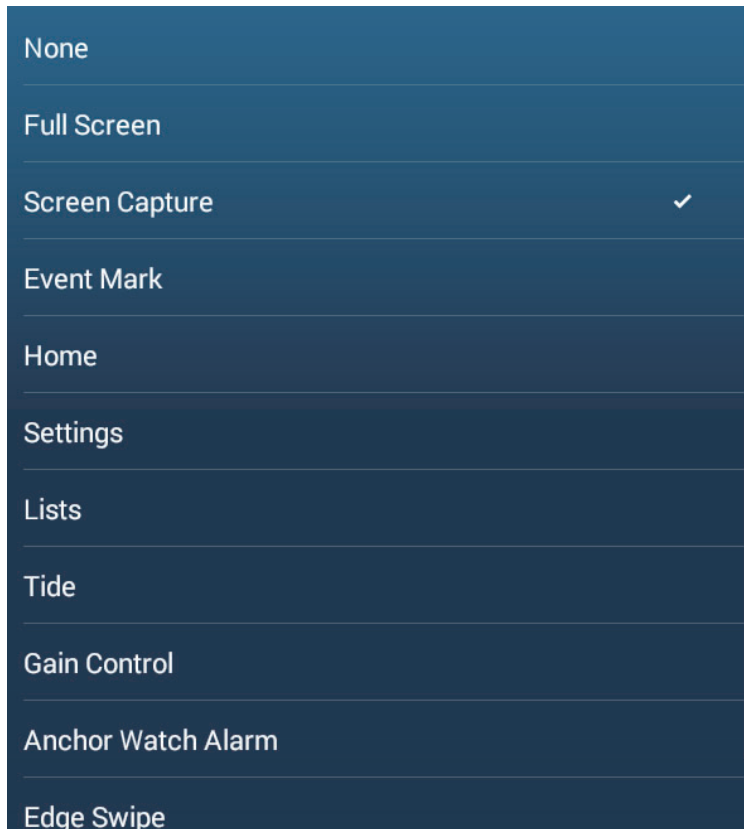

2. Tap a function among the following:
 - [None]: Nothing happens.
 - [Full Screen]: On a split screen, then tap function makes the active screen a full screen. Tap the screen again to revert to the split screen.
 - [Screen Capture]: Capture the screen and save it to the storage media (microSD card or USB flash memory) connected to the USB port. After the screen is copied, the message "Screenshot taken" appears for three seconds. The chart plotter screen shows the photo icon () at the geographical position where the screen was captured. The file name is automatically recorded, with the date and time the screenshot was taken and the .png extension. To move, edit, delete a photo icon, tap it to show the pop-up menu, then take the appropriate action. If you are using the TZ First Mate™ feature, the screenshot can be seen on a smartphone, tablet.
 - [Event Mark]: Record an event. The [Creating Events] pop-up menu appears, from which you can select the mark to put at the position the mark was selected (see subsection 4.2.2).
 - [Home]: Open the Home screen (see section 1.6).
 - [Settings]: Open the [Settings] menu (see section 1.15).

[Lists]: Open the [Lists] menu (see section 1.15 and section 4.7).

[Tide]: Open the tide graph (see section 1.15 and subsection 3.2.4).

[Gain Control]: Open the gain adjustment slider bar in the radar, fish finder, or multi beam sonar mode. See section 6.3 (radar), subsection 7.5.2 (fish finder).

[Anchor Watch Alarm]: Turn the anchor watch alarm on or off (see section 2.10.5).

[Edge Swipe]: The arrow keys shown in the right-hand figure appear on the screen. While displayed, you can “edge swipe” with the optional remote control MCU-002, joystick of the MCU-004, EDGE key, cursor pad or scroll pad of the MCU-005, and the cursor pad of the TZT9F/12F.

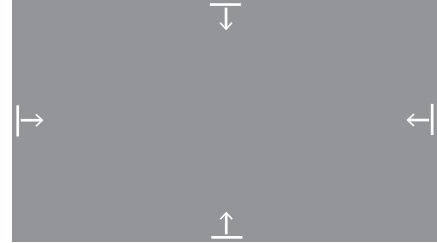

[Fusion]: Open the Fusion screen (see section 11.1). Shown when Fusion equipment is connected.

[Fusion Bar]: Show the Fusion operation bar (see section 11.2). Shown when Fusion equipment is connected.

3. Tap the close button on the title bar to finish.

1.17 Language

The default interface language is English (United States). To change the language, do as follows:

1. Go to the Home screen, then tap [Settings]→[General]→[Language].
2. Tap the language to use. The message "APPLICATION HAVE TO RESTART NOW! DO YOU WANT TO RESTART APPLICATION?" appears.
3. Tap [OK].
The system takes approximately five minutes to optimize the system for the new language setting,

1.18 Man Overboard (MOB)

The MOB function is used to mark the location of man overboard, from the chart plotter and radar displays. At the moment the MOB function is activated, the MOB mark is put at the current position, on both the chart plotter and radar displays.

How to mark the MOB position

Tap [MOB] on the Home screen. The chart plotter display opens, the MOB mark

() is at the location at the moment MOB was activated, and the MOB location is automatically set as destination. For the TZT9F/12F, long push the **EVENT/MOB** key to enter the MOB mark.

At the moment of activation the following occurs.

- The message "MOB" flashes in the status bar, with yellow characters on a red background. The aural alarm sounds if it is enabled. Tap the status bar to stop the flashing indication and silence the aural alarm.
- The MOB mark is highlighted.

1. SYSTEM INTRODUCTION

- A yellow line connects between the MOB mark and current location. This line shows the straightest course between own ship and the MOB mark.
- If a FM-4800 VHF Radiotelephone is connected to the same network, the MOB information is also sent to the FM-4800 and can be sent as a DSC message.

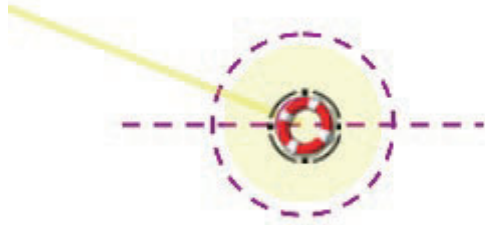

MOB mark on the plotter display



MOB mark on the radar display

MOB information

Tap a MOB mark to display the following MOB data: latitude, longitude, DTA (distance to the MOB), ETA (Estimated Time of Arrival at the MOB), depth*.

* Depth data requires a depth sensor.

How to delete a MOB mark

Tap a MOB mark to display the pop-up menu, then tap [Delete]. However, if the MOB position is set as destination, the MOB point (highlight) remains on the screen and the destination is not canceled. To erase a MOB mark set as a destination, you must first stop navigation to the MOB. Tap the MOB mark, select [Stop Nav] (to cancel the destination), tap the mark again, then tap [Delete].

1.19 Wireless LAN Settings

You can connect to the internet with the wireless LAN signal to download weather information (see chapter 13). Also, using wireless LAN, you can connect an iOS or Android™ device to monitor the NavNet TZtouch3 from the connected device.

The wireless LAN can be used two ways:

- **Use existing LAN:** Connect to an existing LAN access point (in a harbor, etc.) to download weather information.
- **Create local network:** Create an access point from which the NavNet TZtouch3 can be monitored, controlled from a smartphone or tablet.

About the wireless LAN

- The wireless LAN function is available only in the countries which have acquired radio wave certification. Turn this function off in countries which do not have radio wave certification. Ocean-going vessels that have radio wave certification can use the wireless LAN function in any country that has acquired radio wave certification. Vessels with radio wave certification that enter a country that does not have radio wave certification may use the wireless LAN function only onboard the vessel. Available countries (as of 04/2018): USA, Canada, New Zealand, Australia, Japan, and all countries of the EU.
- The communication rate and effective range for the wireless LAN can be affected by electromagnetic waves, interfering objects, or access point location.
- We strongly recommend using the wireless LAN with encrypted connection. Otherwise unauthorized access by a third party can occur, which can cause loss of data or system crash.
- We recommend changing the initial password before using a local wireless network.

1.19.1 How to connect the existing LAN

1. Go to the Home screen, then tap [Settings]→[General]→[Connect to the Internet].

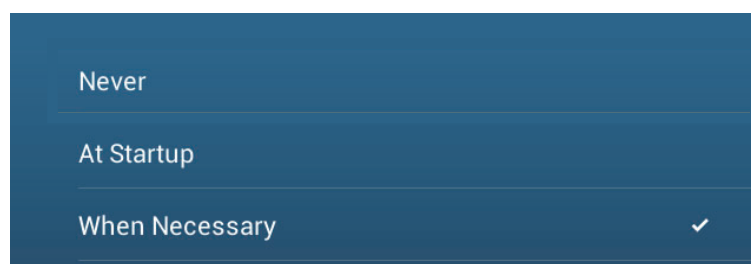

2. Tap [When Necessary]. Tap "<" to go back one layer.
3. Tap [Wireless LAN Settings]→[Wireless Mode].

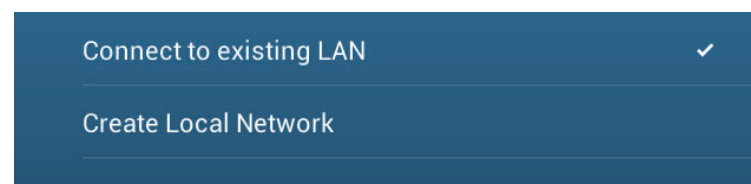

4. Tap [Connect to existing LAN]. Tap "<" to go back one layer.

1. SYSTEM INTRODUCTION

- Turn on [Wireless] to see the available WLAN networks at the bottom of the screen.



- Tap the network to use.

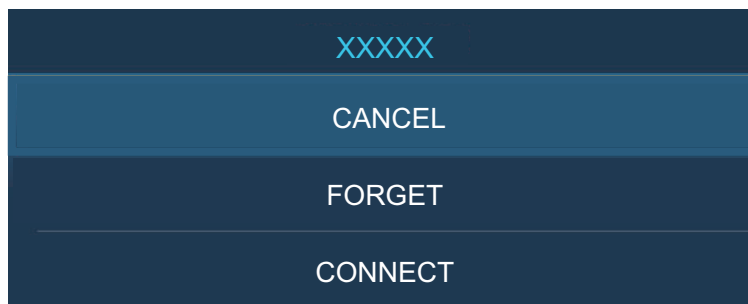

- Tap [Connect] to show the network key input window.

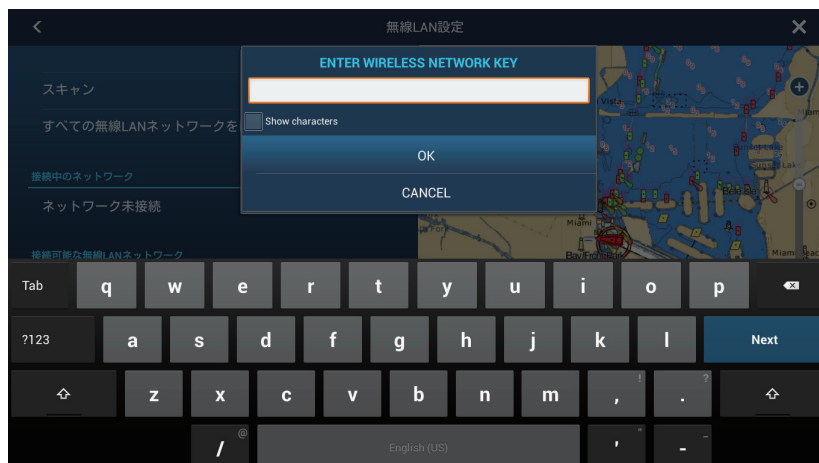

- Enter the network key, then tap [OK].
When the connection is successful, the network details appear below [CURRENT CONNECTED NETWORK].
Note: If the network key is incorrect, an error message appears. Enter the correct key and tap [OK] again.
- Tap X on the title bar to close the menu.

1.19.2 How to create a local wireless network

Note 1: Do the procedure with [Local Network] in [Wireless LAN Settings] turned off.

Note 2: It may not be possible to connect to a local network if the network is unstable. In this case, turn [Wireless] off and on. Connect via existing LAN network.

Note 3: Confirm that [When Necessary] is selected in [Connect to the Internet] before doing the procedure.

1. Go to the Home screen, then tap [Settings]→[General]→[Wireless LAN Settings]→[Wireless Mode].
2. Tap [Create Local Network], then tap "<" to go back one layer.

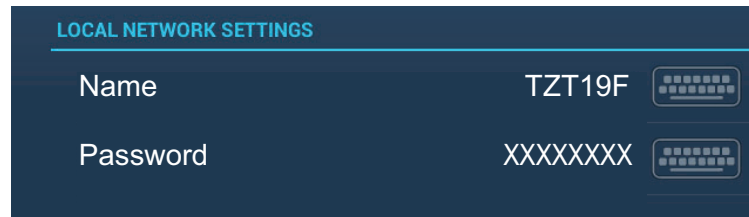

3. Tap [Name].
4. Enter the name of the network, then tap [✓].
5. Tap [Password].
6. Enter the password, then tap [✓]. (If the password is wrong, an error message appears. Tap the [OK] button then reenter the password.)
7. Turn on [Local Network] in [Wireless LAN Settings] to connect to the network.
8. Tap X on the title bar to close the menu.
9. Connect to NavNet TZtouch3 from the NavNet app on your tablet or smartphone.

1.20 How to Create and Login to Your My TimeZero™ Account

You will need to create a My TimeZero™ account to access the cloud and My Friends (social network) functions. Prepare a PC or mobile device to complete the registration.

1. Connect your NavNet TZtouch3 to the internet. See section 1.19.
2. Open the [Settings]→[General] menu, then select [Login] in the [MY TIMEZERO] section.

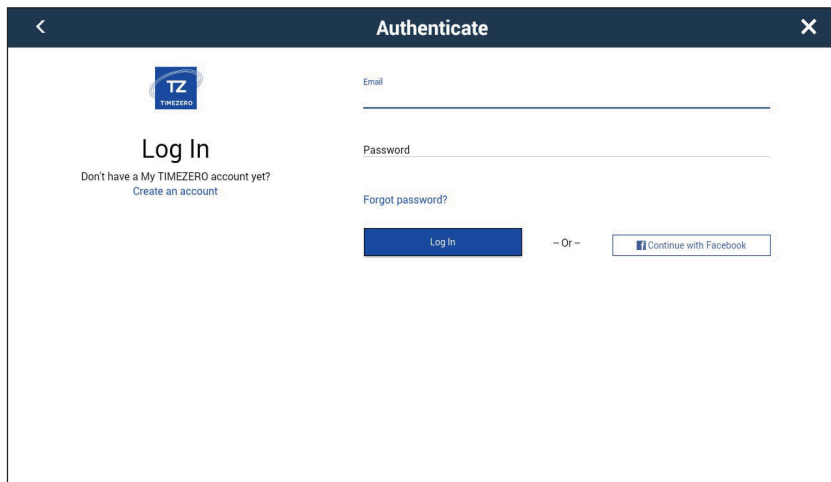

The screenshot shows the 'Authenticate' screen with a dark blue header. On the left is the My TimeZero logo and the text 'Log In' with a link to 'Create an account'. On the right are input fields for 'Email' and 'Password', a 'Forgot password?' link, a blue 'Log In' button, and a 'Continue with Facebook' button.

Note: You can also login with your Facebook account.

3. Tap [Create an account].

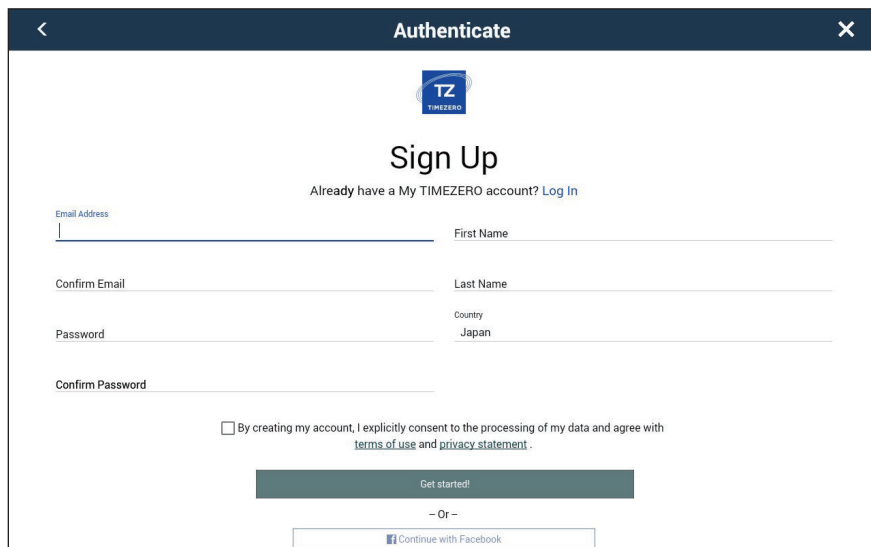

The screenshot shows the 'Authenticate' screen with a dark blue header. On the left is the My TimeZero logo and the text 'Sign Up' with a link to 'Log In'. Below are input fields for 'Email Address', 'First Name', 'Last Name', 'Country' (pre-filled with 'Japan'), 'Password', and 'Confirm Password'. There is a checkbox for terms and conditions, a green 'Get started!' button, and a 'Continue with Facebook' button.

4. Fill in all fields. Check the checkbox if you want to subscribe to the Newsletter.

- Click [Get started!] to finish.

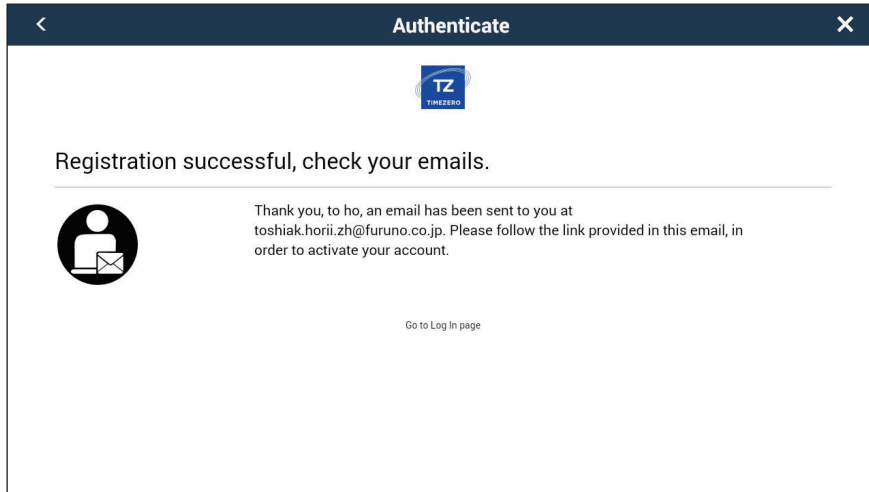

- From a PC or mobile device, follow the link provided in the e-mail to log into your account. Leave the NavNet TZtouch3 as is.
- Tap [Go to Log in page] on this equipment.

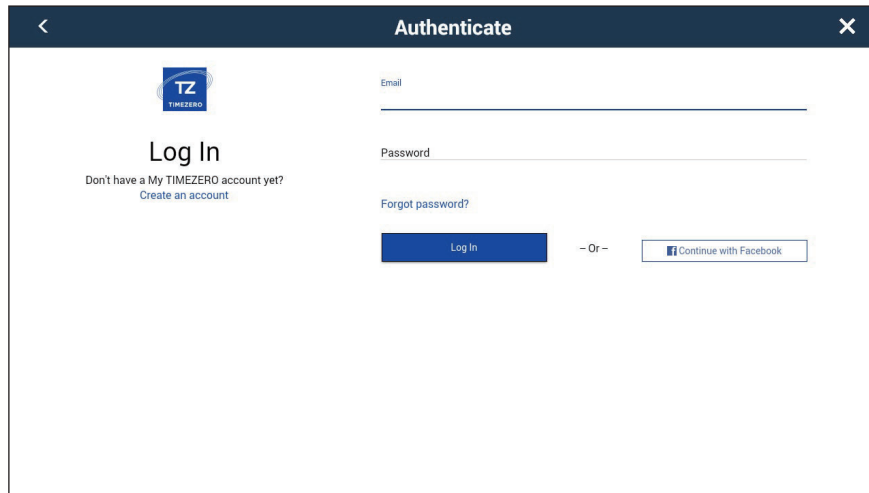

- Enter the e-mail address used to register the account, and your password.
- Tap [Log in].

The name used to create the account appears in the [Logged As] field. The Status bar shows (in yellow) "You are logged as (your name)" and several beeps sound (if alarm sound is turned on).

1.21 PIN Code Lock

The PIN code lock feature allows you to require a four-digit password to be entered upon startup, keeping your data safe against theft.

Follow the procedure below to set the password.

Note 1: Make a note of your password and store it in a safe place.

Note 2: Set a password for each MFD (Multi Function Display) in the network.

1. Open the [Settings]→[General] menu.
2. Turn on [Password Lock].
You will use this password to unlock the MFD. If you forgot the password, the unit cannot be unlocked (with a new password). Request a Furuno dealer to unlock the unit. After the unit is unlocked all factory settings are restored. All your user data (points, routes, tracks, boundaries, catches, photos, settings) will be lost.
3. Tap [OK] to show the password input screen.

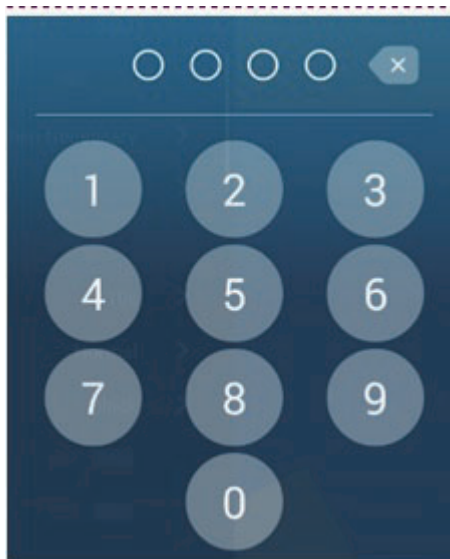

4. Enter your password with four digits. You are asked to confirm the password.
5. Re-enter your password. The message "Password protected" appears.
6. Tap [OK] to finish.

To release password protection, turn off [Password Lock] in the above procedure. The message "The password will be removed and all units in the network will no longer be protected. Are you sure you want to proceed?" Tap [OK].

2. CHART PLOTTER

This chapter shows you how to do the following:

- Use and prepare the chart plotter display
- Set chart plotter related alarms
- Control the track

2.1 Chart Type

A world map in raster chart format is included in your unit. A vector chart for the US coastline (Alaska and Hawaii included) is provided also. To use this chart plotter as a navigational aid, electronic charts (stored internally) for the area you navigate are required. Contact your dealer about charts for your area.

There are two types of charts available with this equipment.

[Raster]: Raster charts are digitized scans of NOAA paper charts. Raster charts have information like notes, source diagrams, tidal diamonds, horizontal and vertical datum, etc.

[HO]: HO charts are S-57 format vector charts (digital files) that contain marine features and information created for marine navigation. These charts are made according to the International Hydrographic Organization (IHO). HO charts are available from C-MAP, Navionics, Mapmedia, and NOAA (National Oceanic and Atmospheric Administration).

How to select a chart type

1. Go to the home screen, then select the [Chart Plotter] display.
2. Open the Layers menu.
3. Tap the chart type from among [Auto], [Raster] or [HOs].

*: [Auto] automatically switches the chart type according to chart availability and priority.

2.2 Range Zoom In, Zoom Out

You can zoom in and zoom out around a specific position. The range is displayed with the scale bar at the bottom left corner of the chart plotter screen.

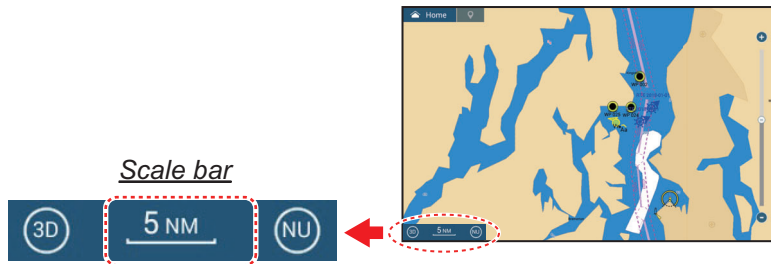

How to zoom in or out the display range

Method 1: Pinch the chart plotter display.

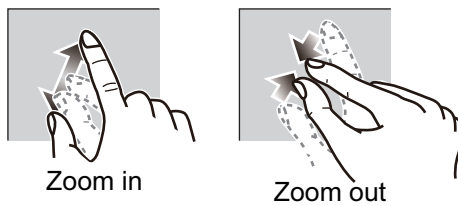

Method 2: Operate the slider to bar to adjust the display range, using one of the methods shown below.

- 1) Drag the slider.
- 2) Tap the bar.
- 3) Tap the "+" or "-" icon on the slider.

(The slider bar is shown in the default setting. The slider bar can be shown or hidden with [Show Scale Slider] in the [Settings]→[Chart Plotter] menu.)

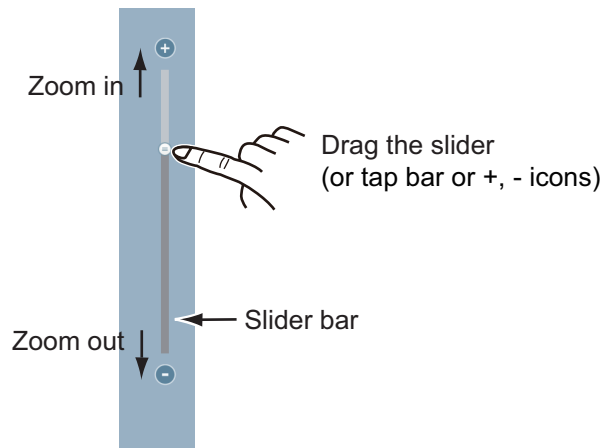

Note 1: When a raster chart is displayed, you can see whether the appropriate range is set by the display color of the scale bar displayed at the bottom left corner of the screen.

- **Black:** Range is appropriate for chart accuracy.
- **Red:** Range is inappropriate for chart accuracy.

Note 2: You can zoom the display range in or out from the preview screen.

Method 3 (TZT9F/12F only): Turn the RotoKey™ clockwise to zoom in. Turn counter-clockwise to zoom out.

2.3 Orientation Mode

The chart can be shown in head-up or north-up orientation. Tap the orientation mode switch, [HU] or [NU], whichever is shown, at the bottom left corner to change the orientation mode.

- **North Up:** North is at the top of the screen. When your heading changes, the own ship icon moves according to heading. This mode is for long-range navigation.
- **Head Up:** Displays the chart with the current compass heading of your ship at the top of the screen. The heading data from a compass is required. When the heading changes, the own ship icon remains fixed, and the chart picture rotates according to heading.

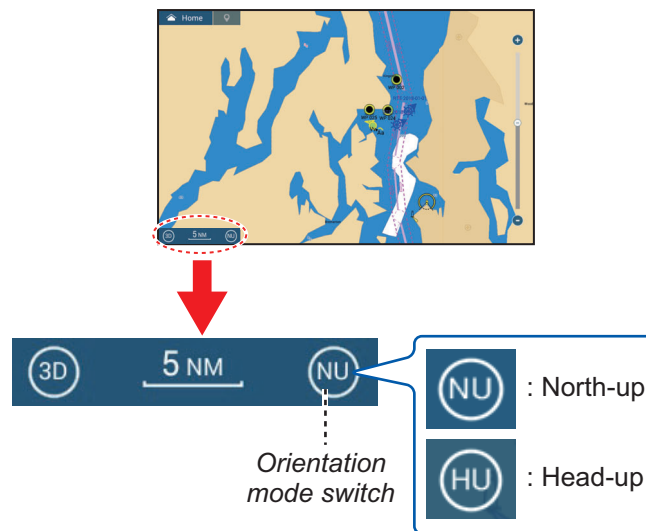

2.4 How to Move the Chart

You may need to move the chart when the own ship icon is off-screen, you want to view an area off-screen or enter a mark off-screen. The chart must be moved to do this.

To move the chart, drag the on-screen display and show the area you want to work with.

Note: To return your ship icon to the center of the display and show the immediately surrounding area, tap the [Center Vessel] icon at the top-right corner of the display.

2.5 The Own Ship Icon

2.5.1 Description

The own ship icon (red) marks current position and moves according to your vessel's movement. The following information also appears with the own ship icon.

- **Heading line:** a straight line that runs from your position and shows the current heading.
- **COG vector:** a vector line that runs from the own ship icon and points in the direction in which your ship is now moving.
- **Turn direction indicator:** points in the direction your vessel is turning, starboard or port. In the figure to the right, the starboard turn indicator is shown.

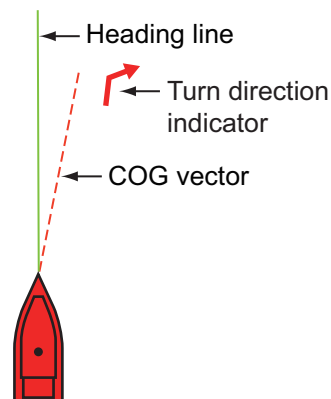

2.5.2 How to show or hide the COG vector, heading line

Tap the own ship icon to show the pop-up menu.

Set [COG] or [HDG] to [ON] or [OFF] as required. The turn direction indicator is also turned on or off with [COG].

Note 1: The color of the COG vector (including the turn direction indicator) can be changed. Go to the home screen, then select [Settings]→[Ship & Track]→[COG Vector Color].

Note 2: The thickness of the heading line can be changed. Go to the home screen, then select [Settings]→[Ship & Track]→[Heading Line Thickness]. Set the thickness with the software keyboard or slider bar. [1] is thinnest; [5] is thickest.

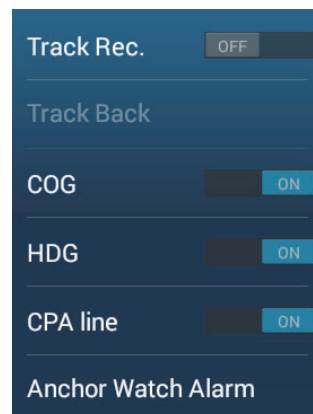

2.5.3 COG vector length

The COG vector can be set to show one of the following:

- Position after traveling the distance set in the menu.
- Estimated position after traveling the time set in the menu.

The tip of the vector is the estimated position of your ship at the end of the selected time or distance. The greater the distance or the time, the longer the COG vector. To change the COG vector length, do the following.

1. Open the home screen, then tap [Settings] → [Ship & Track] → [COG Vector].



2. Tap [Distance] or [Time] as required, then tap the [<] icon at the title bar. If you selected [Distance], go to step 3. For [Time], go to step 5.

3. Tap [COG Vector Length] to display the software keyboard.
4. Set the length for the COG vector, then tap [✓]. Go to step 6.
5. Tap [COG Vector Time], then tap the time for the COG vector.



6. Tap the close button on the title bar to finish.

2.5.4 Own ship icon orientation

You can select the orientation of the own ship icon to heading or COG.

1. Open the home screen, then tap [Settings]→[Ship & Track].
2. Tap [Vessel Icon Orientation].
3. Tap [Heading] or [COG].
4. Tap the close button on the title bar to finish.

2.6 How to Find Information Chart Object and Chart Information

You can find chart object and chart information from the pop-up menu.

2.6.1 Chart object information

Simple information

Tap an object to show its name, specifications, position, and range and bearing, in the pop-up menu.

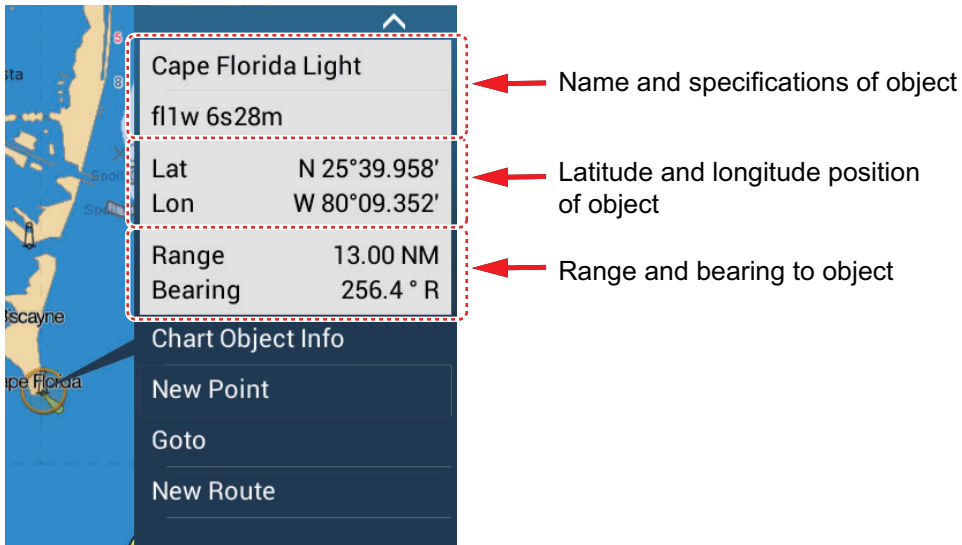

Detailed information

Tap an object to show the pop-up menu. Tap [Chart Object info] on the pop-up menu to show detailed information.

LANDMARK	
Category	tower
Conspicuous	visually conspicuous
Source date	Saturday, October 5, 2002
POINT INFO	
Lat	N 25°43.981'
Lon	W 80°09.634'
Bearing	163 °
Range	21.34 NM

2.6.2 Chart information

Tap a location on the chart not occupied by a chart object, then tap [Chart Info] on the pop-up menu.

CHART INFO	
Chart type	Vector charts
Chart manufacturer	N.O.A.A.
File name	SDUS00VS57MAP10.DBV
Chart name	US5FL22M
Chart Number	US5FL22M
Edition #	26
Revision Date	4/4/2011
Revision #	3
Chart Scale	10,000
POINT INFO	
Lat	N 25°44.384'

2.7 How to Find the Range and Bearing Between Two Locations

The [Distance] item in the Slide-out menu measures the range and bearing between any two locations on your chart. Range and bearing between the two locations are digitally indicated on the screen.

1. Open the Slide-out menu.
2. Tap [Distance].

A dashed line runs between the start location and the 2nd location. The range, bearing, SOG, and TTG to the 2nd location is shown at the top of the screen.

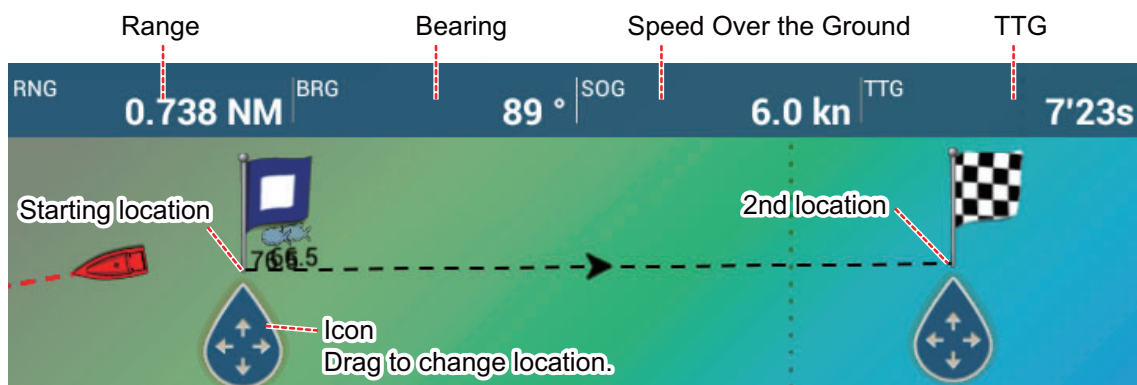

3. To change the location of either point, drag and drop.
4. To quit the distance measurement, tap [Cancel Ruler] at the top right-hand corner of the screen.

2.8 Multiple Chart Plotter Displays

Three chart plotter displays can be shown on one screen. This arrangement lets you see the conditions around your ship on both short and long ranges and a different perspective. Also, you can see how your ship moves toward your destination from more than one angle. For example, you can show one display in 3D and the other two in 2D.

The following features can be adjusted individually.

- AIS
- ARPA
- Display range
- Chart orientation
- Chart type
- Scroll the chart
- Overlays (radar, satellite photo, depth shading, tide icon, tidal current icon, ACCU-FISH™ (see section 7.14), points, routes, tracks)
- 2D and 3D: Independent orientation (2D, 3D) and view point (3D) are possible

The following example shows a three-way split chart plotter display.

Chart plotter display 2

Display range: 3 NM

Orientation: Head-up

Perspective: 2D

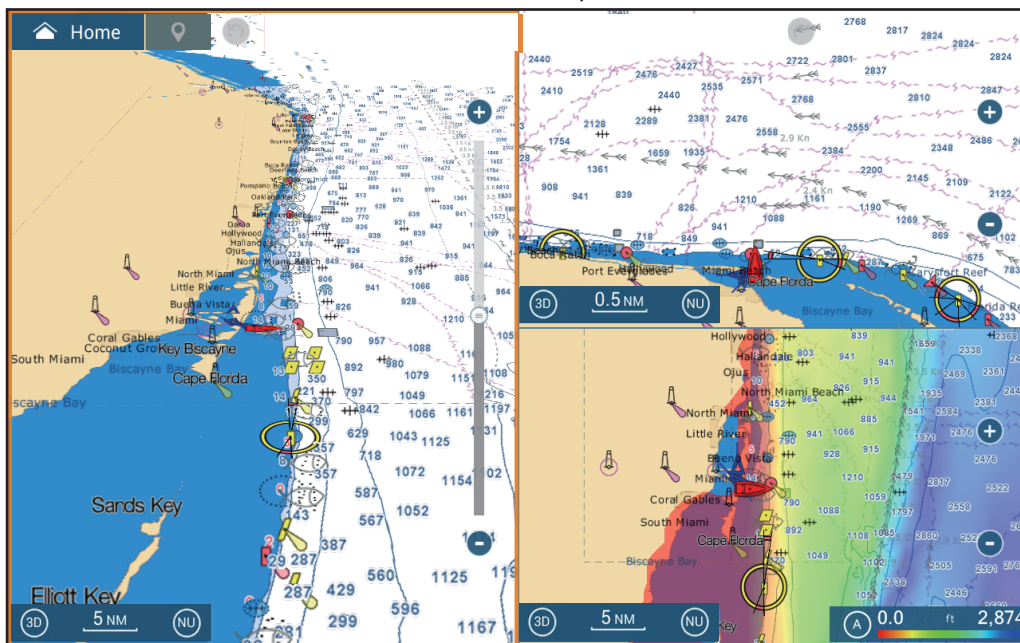

Chart plotter display 1

Display range: 30 NM

Orientation: North-up

Perspective: 3D

Chart plotter display 3

Display range: 40 NM

Orientation: North-up

Perspective: 2D

Overlay: Depth shading

2.9 Cartographic Text and Objects on Vector Charts

This section shows you how to show or hide the cartographic objects and text information that appear on the vector charts.

2.9.1 Control visibility of text and object information in vector charts

The [Settings]→[Vector Chart] menu controls the visibility of text and object information, for example, buoy names and light description.



[Chart Object Size]: Drag the slider to set the chart object size (setting value: 50 to 200%).

[Chart Color Palette]: Set the chart color pattern. [Standard] is this equipment's original color palette, [S-52] complies with the official S-52 charts, and [Sunlight] provides a high contrast palette.

[Chart Symbols]: Select the chart symbol type. [S-52] are the official IMO symbols (also referred to as simplified symbols) library for ECDIS. [International] symbols are the copy of paper chart symbols of IALA symbols library (US symbols library).

[Shallow Contour]: Set the shallow depth (setting range: 0.0, 3.3, 6.6, 9.8, 13.1, 16.4, 19.7, 23.0, 26.2, 29.50, 32.8 ft). Show shallow depth contours in dark blue.

[Safety Contour]: Set the safety depth (setting range: 0.0, 3.3, 6.6, 9.8, 13.1, 16.4, 19.7, 23.0, 26.2, 29.50, 32.8, 49.2, 65.6, 98.4, 164 ft). Show safety depth contours in medium blue.

[Deep Contour]: Set the deep depth (setting range: 0.0, 3.3, 6.6, 9.8, 13.1, 16.4, 19.7, 23.0, 26.2, 29.50, 32.8, 49.2, 65.6, 98.4, 164, 328, 656, 984, 1,640 ft). Show deep-depth contours in light blue. Depths greater than set here are shown in white.

[Text (Important)]: Show or hide the important text information.

[Text (Other)]: Show or hide the other text information.

[Display Buoy Names]: Show or hide the buoy names.

2. CHART PLOTTER

[Display Light Description]: Show or hide the light descriptions.

[Display Light Sectors]: Show or hide light sectors for fixed beacons.

[Display Routes]: Show or hide routes.

[Display Routes Bearings]: Show or hide route bearings.

[Display Soundings]: Show or hide depth soundings.

[Display Soundings in Red]: Spot soundings whose depths are lower than the value selected on the [Shallower than...] menu are shown in red.

[Soundings in Red up to]: Select the value for the [Display Soundings in Red] menu (setting range: 0.0, 3.3, 6.6, 9.8, 13.1, 16.4, 19.7, 23.0, 26.2, 29.50, 32.8, 49.2, 65.6, 98.4 ft).

[Obst. Depth Below Safety]: Show or hide obstruction depths under the safety depths.

[Display Seabed]: Show or hide seabed composition indication, for example, mud, sand, rock.

[Cautionary Areas]: Show or hide the cautionary areas that appear on the chart.

[Reset Default Settings]: Select this menu item to restore default settings for the [Vector Chart] menu.

2.9.2 Control visibility of cartographic objects in S-52 charts

The [Settings]→[S-52 Display] menu controls the visibility of S-52 cartographic objects, for example, lights and fog signals.

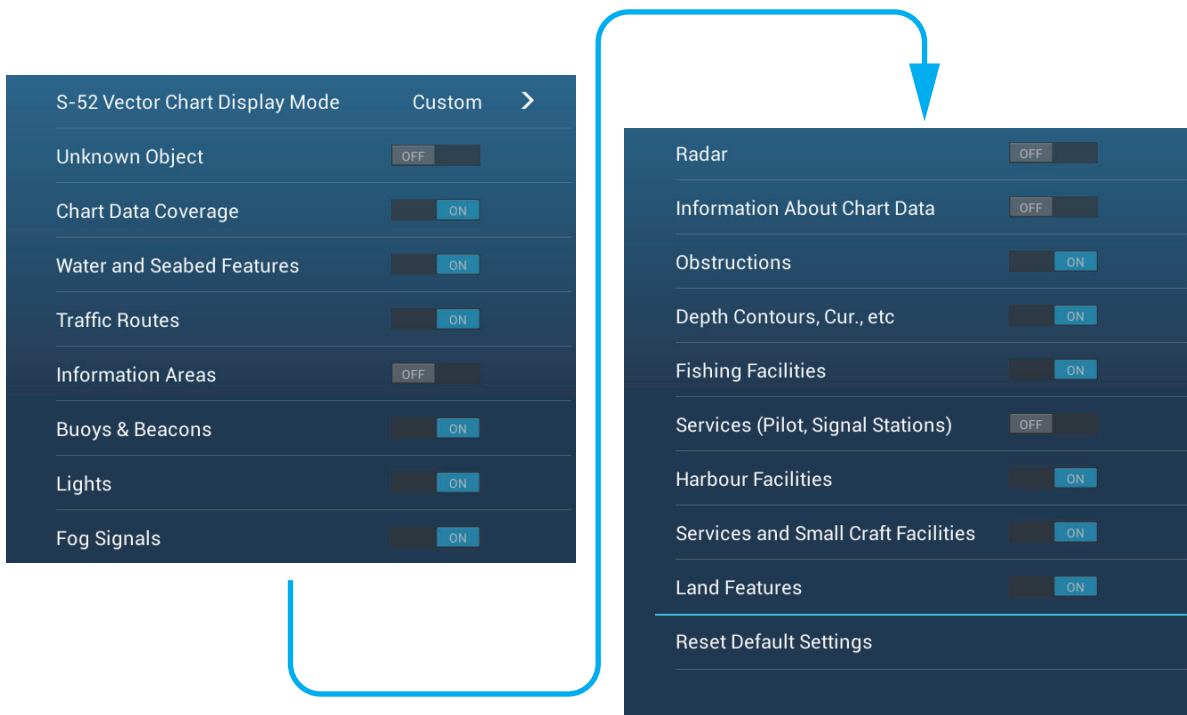

[S-52 Vector Chart Display Mode]: Set the level of information to show on the chart. The selections are [Custom], [Base], [Standard], [Other], and [Fishing]. The chart features are turned on or off according to setting.

Note: The following menu items except [Reset Default Settings] are unavailable when you select the mode other than [Custom]

[**Unknown Object**]: Show or hide unknown objects that appear on the chart.

[**Chart Data Coverage**]: Show or hide the geographic names and geographic objects.

[**Water and Seabed Features**]: Show or hide the water and seabed presentation.

[**Traffic Routes**]: Show or hide the marine traffic routes.

[**Information Areas**]: Show or hide the information areas that appear on the chart.

[**Buoys & Beacons**]: Show or hide the buoys and beacons.

[**Lights**]: Show or hide the sector of light that a fixed beacon shines.

[**Fog Signals**]: Show or hide the structure that sends a fog signal.

[**Radar**]: Show or hide the radar buoy.

[**Information About Chart Data**]: Show or hide the chart data information.

[**Obstructions**]: Show or hide obstructions (wrecks, etc.)

[**Depth Contours, Cur., etc**]: Show or hide the depth contours, tidal currents and magnetics.

[**Fishing Facilities**]: Show or hide the location of fishing facilities.

[**Services (Pilot, Signal Stations)**]: Show or hide the location of pilots and signal stations.

[**Harbour Facilities**]: Show or hide the location of harbour facilities.

[**Services and Small Craft Facilities**]: Show or hide the services for ship and small craft.

[**Land Features**]: Show or hide the cartographic features that are shown on land.

[**Reset Default Setting**]: Select this menu item to restore default settings for the [S-52 Display] menu.

2.10 Alarms

The various chart plotter alarms alert you (with audiovisual alarms) when the conditions specified are met. These alarms are:

- Cross track error alarm
- Sea surface temperature alarm
- Anchor watch alarm
- Boundary alarm (see section 4.17)
- Depth alarm
- Speed alarm
- Wind speed alarm
- Low fuel alarm

When an alarm is generated, the name of the offending alarm appears in the status bar (red background with yellow text) at the top of the screen and flashes. If [Alarm Sound] ([Alarm] menu) is active, the unit beeps.

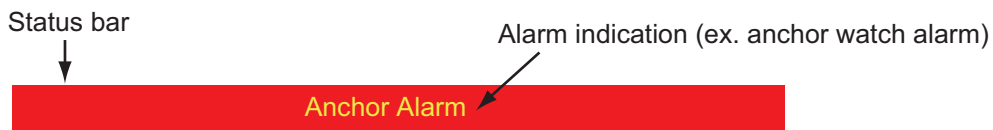

Note: If [Sound Alarm Until Acknowledged] is set for [OFF], the unit continues to beep until the cause of the alarm is removed.

How to open the [Alarm] menu

1. Open the home screen, then tap [Settings]→[Alarm].

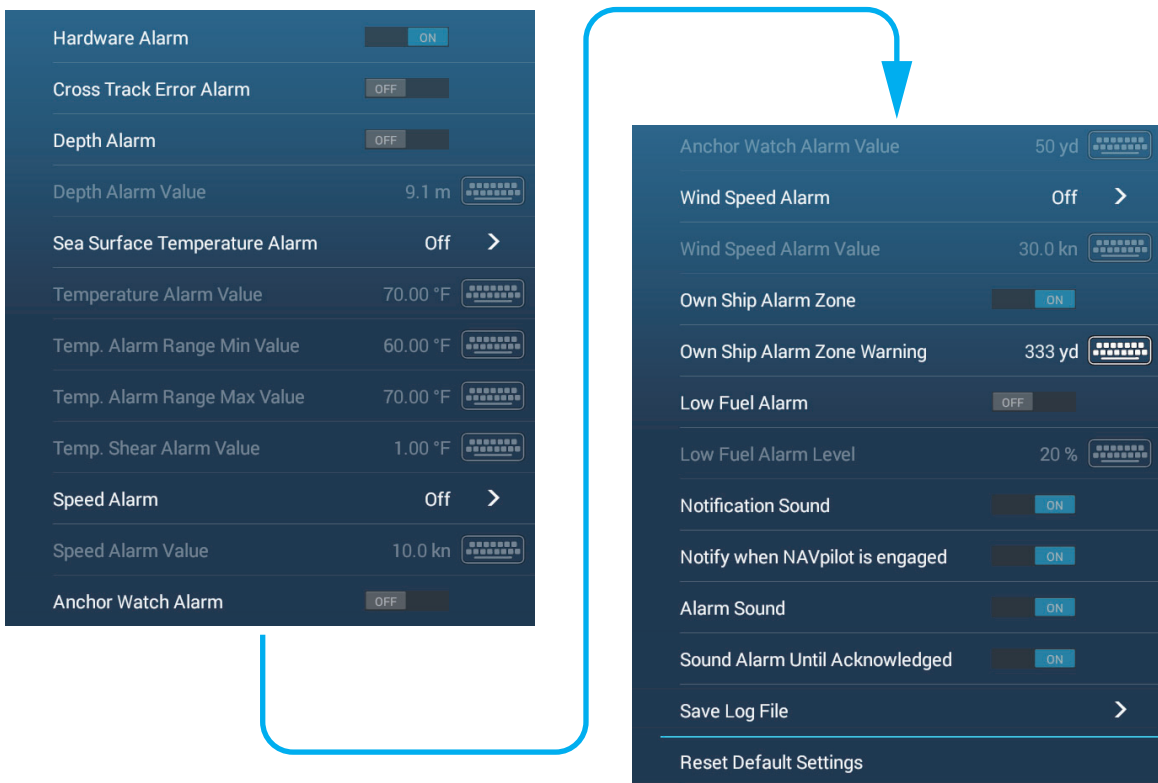

2.10.1 Cross Track Error alarm

The cross track error alarm tells you when your ship goes off course by more than the limit set (cross track error alarm boundaries).

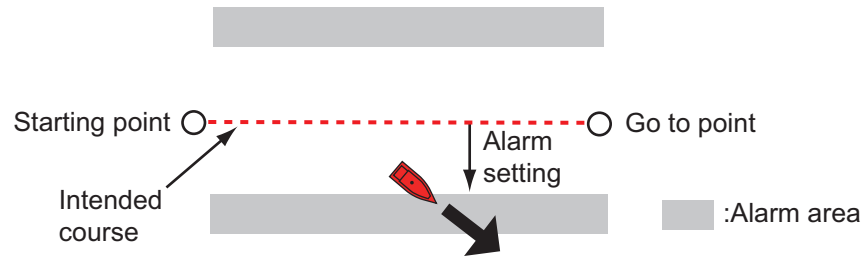

1. Turn on [Cross Track Error Alarm] in the [Alarm] menu.
2. From the home screen, tap [Settings] → [Routes] → [Cross Track Error Value] to display the software keyboard.
3. Set the value, then tap [✓].
4. Tap the close button on the title bar to finish.

Note: To disable this alarm, turn it off at step 1 of the above procedure.

2.10.2 Depth alarm

The depth alarm tells you when the depth to the bottom is shallower than the value you set. Requires depth data.

Note: Requires connection to appropriate sensor.

1. Turn on [Depth Alarm] in the [Alarm] menu.
2. Tap [Depth Alarm Value] to display the software keyboard.
3. Set the value, then tap [✓].
4. Tap the close button on the title bar to finish.

Note: To disable this alarm, turn it off at step 1 of the above procedure.

2.10.3 SST alarm

The sea surface temperature alarms tells you when the sea surface temperature is over, under, within, or out of range of the temperature you set. Requires a temperature sensor.

Note: Requires connection to appropriate sensor.

1. Tap [Sea Surface Temperature Alarm] on the [Alarm] menu.

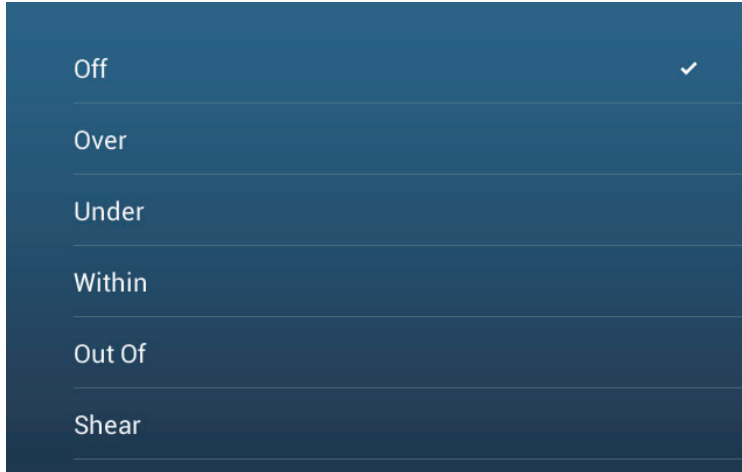

2. Tap [Over], [Under], [Within], [Out of] or [Shear]. Follow the appropriate procedure below.

[Over] or [Under]

The [Over] or [Under] alarm sounds when the temperature is over or under the set value, respectively.

- 1) Tap [Temperature Alarm Value] to display the software keyboard.
- 2) Set the value, then tap [✓]. Go to step 3.

[Within] or [Out of]

The [Within] or [Out of] alarm sounds when the temperature is within or out of the temperature range set, respectively.

- 1) Tap [Temp. Alarm Range Min Value] to display the software keyboard.
- 2) Set the minimum value, then tap [✓].
- 3) Tap [Temp. Alarm Range Max Value] to display the software keyboard.
- 4) Set the minimum value, then tap [✓]. Go to step 3.

[Shear]

The shear alarm sounds when the temperature exceeds the alarm setting within one minute.

- 1) Tap [Temp. Shear Alarm Value] to display the software keyboard.
- 2) Set the value, then tap [✓]. Go to step 3.

3. Tap the close button on the title bar to finish.

Note: To disable this alarm, turn it off at step 2 of the above procedure.

2.10.4 Speed alarm

The speed alarm tells you when the speed of your ship is over or under the limit set. Set the value at [Speed Alarm Value].

Note: Requires connection to appropriate sensor.

1. Tap [Speed Alarm] on the [Alarm] menu.
2. Tap [Over] or [Under].
3. Tap [Speed Alarm Value] to display the software keyboard.
4. Set the value for [Over] or [Under] then tap [✓].
5. Tap the close button on the title bar to finish.

Note: To disable this alarm, turn it off at step 2 of the above procedure.

2.10.5 Anchor watch alarm

The anchor watch alarm tells you that your ship has moved a distance greater than the set value when the ship must not be moving.

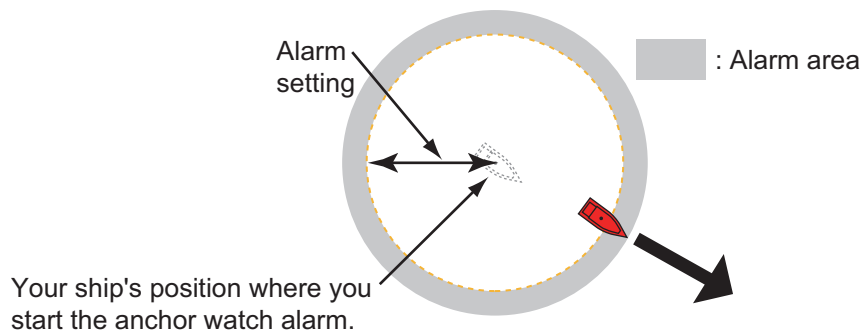

The anchor watch alarm setting is shared across all the NavNetTZtouch3 units in the same network. A smartphone or tablet can also be used to set the alarm.

Note: Login to My TimeZero account to enable sharing of data among NavNetTZtouch3 units.

1. Turn on [Anchor Watch Alarm] in the [Alarm] menu.
2. Tap [Anchor Watch Alarm Value] to display the software keyboard.
3. Set the value (radius of the anchor watch zone), then tap [✓].
4. Tap the close button on the title bar to finish.

A green circle, with an anchor symbol at its center, marks the anchor watch zone. If the boat nears the edge of the circle, the message "Anchor Watch Warning" (yellow status bar) appears in the status bar and the circle turns yellow. If the boat goes out of the circle, the message "Anchor Watch Alarm" (red status bar) replaces "Anchor Watch Warning" and the circle turns red and flashes.

To reset the anchor watch alarm zone (when your boat goes out of the zone), tap the [Reset] icon on the navigation bar. A message asks you if you are sure to reset the anchor watch alarm. Tap [Yes] to reset the zone.

To move the zone or adjust the zone radius, tap the anchor symbol or the red circle to show the pop-up menu. Tap [Edit Anchor Watch]. To move the zone, drag the position icon. To adjust the radius of the zone, drag the zone size icon. Tap [End Editing] at the top right corner to finish.

2. CHART PLOTTER

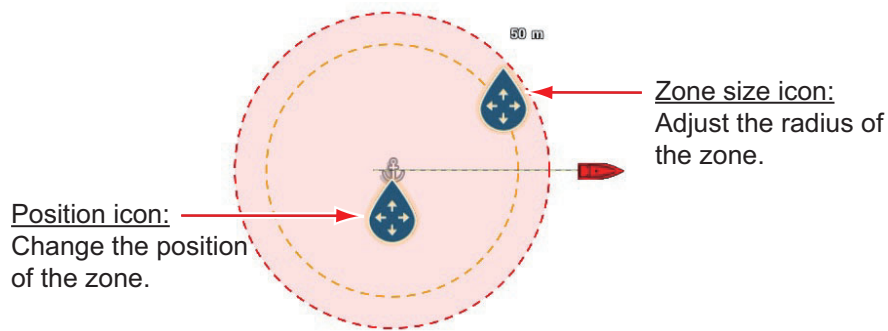

To deactivate the alarm, select [OFF] at step 1 in the procedure. The alarm can also be deactivated from the navigation bar. Tap [STOP]. You are asked if you are sure to stop the anchor watch alarm. Tap [Yes] to deactivate the alarm.

The alarm can also be activated from the chart plotter display. Tap the own ship icon to show the pop-up menu. Tap [Anchor Watch Alarm] to activate the alarm.

If the two finger tap function (short or long) is set for [Anchor Watch Alarm], the anchor watch alarm can be toggled on or off by tapping the screen with two fingers (see section 1.16). When the screen is tapped, the message "Anchor Watch Alarm enabled" (or disabled) appears for three seconds.

Anchor watch position averaging

The anchor watch position may vary depending on received GPS position. If the position changes often, you can average it to prevent random changes. The higher the setting value, the greater the degree of averaging. However, if the averaging is set too high, the calculation of position may slow.

1. From the [Alarm] menu, tap [Anchor Watch Position Averaging].
2. Select a position averaging time.
3. Tap the close button on the title bar to finish.

2.10.6 Wind speed alarm

The wind speed alarm tells you when the wind speed is over or under the limit set. Set the value at [Wind Speed Alarm Value].

1. Tap [Wind Speed Alarm] on the [Alarm] menu.
2. Tap [Apparent] or [True] as required.
[Apparent]: Triggers the alarm when the apparent wind speed exceeds the set speed.
[True]: Triggers the alarm when the true wind speed exceeds the set speed.
3. Tap [Wind Speed Alarm Value] to display the software keyboard.
4. Set the wind speed value, then tap [✓].
5. Tap the close button on the title bar to finish.

2.10.7 Low fuel alarm

The low fuel alarm informs you when your fuel level drops below the setting percentage of fuel).

1. Turn on [Low Fuel Alarm] in the [Alarm] menu.
2. Tap [Low Fuel Alarm Value] to display the software keyboard, set the value, then tap [✓].
3. Tap the close button on the title bar to finish.

Note: To disable this alarm, turn it off at step 1 of the above procedure.

2.10.8 Other Alarm menu items

The followings are the alarm menu items not previously mentioned.

[Hardware Alarm]: The [OFF] setting disables hardware-related alarms.

[Notification Sound]: Activate or deactivate the notification sound (for "Waypoint Crossing" (see section 5.10), "End of Route" (section 4.15) or fish finder alarms (section 7.13)).

[Alarm Sound when NAVpilot is engaged]: Activate or deactivate the notification sound when the autopilot is engaged to or disengaged from this system.

[Alarm Sound]: Disable or enable the buzzer.

[Sound Alarm Until Acknowledged]: Turn this item on to sound the aural alarm until an alarm is acknowledged (see subsection 2.10.9).

[Save Log File]: Save alert list to microSD card.

[Reset Default Settings]: Select this menu item to restore default settings for the [Alarm] menu.

2.10.9 Alarms list

When an alarm is violated, you can see the name of the offending alarm on the [Alarms] list. The list stores both warning and system messages. Open the home screen, then tap [Lists] followed by [Alarms]. Active alarms are flashing and have a red vertical bar at the left margin. Tap an active alarm to acknowledge it and stop the flashing. After the cause of an alarm is removed, the alarm message is moved to [HISTORIC] section. Tap the close button to close the list.

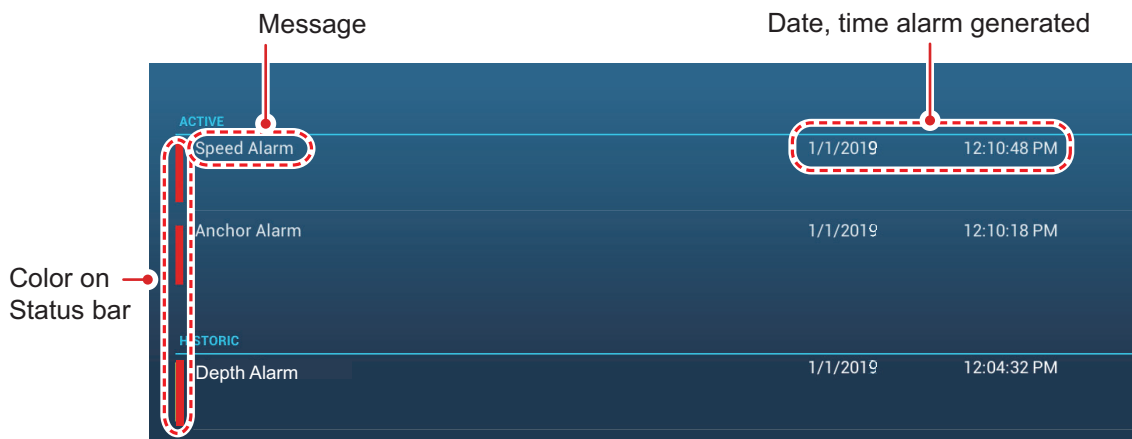

2.11 Track

The track (or movement) of your ship is plotted on the screen with position data fed from the internal GPS navigator (TZT9F/12F/16F) or external navigator (TZT19F). Your track lets you see how your ship has moved over time.

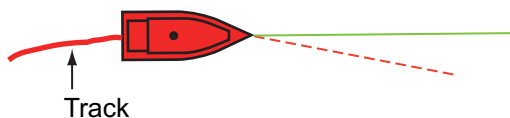

The track is saved to the internal memory if track recording is activated. A line runs between each track point. The internal memory stores a maximum of 30,000 track points.

Track is saved when the power is turned off. Unnecessary track can be deleted. Track can also be used to create a route.

2.11.1 How to start, stop recording the track

Start recording

Method 1: Open the Slide-out menu or tap the own ship icon, then turn [Track] on.

Method 2: Tap the own ship icon to display the pop-up window shown below. Tap [Track Rec.] to turn on track recording.

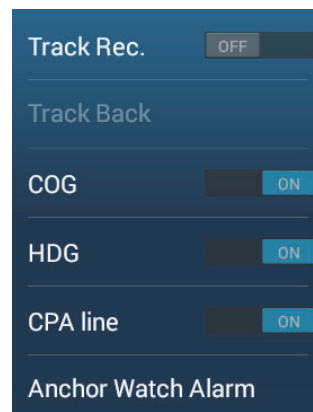

Stop recording

Method 1: Tap the track to show the pop-up window, then tap [Stop Track].

Method 2: Open the Slide-out menu, then turn [Track Recording] off.

Method 3: Tap the own ship icon, then turn [Track Rec.] off.

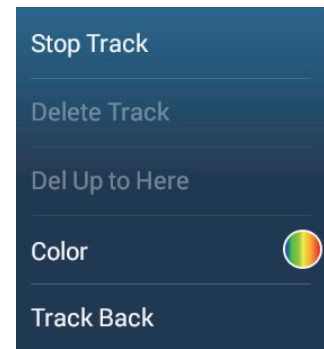
**2.11.2 How to show or hide the track display**

Open the Layers menu and turn [Tracks] on or off.

2.11.3 Track recording interval

Tracks are recorded at specified time or distance intervals to the internal memory of this unit.

A shorter interval gives a smoother, clearly reconstructed track, however the overall distance/time that can be recorded is shorter.

When the positioning data source is one of the devices listed below, the following occurs:

- TZT3 internal GPS (TZT9F/12F/16F)
- TZT2 internal (GPSTZTL12F/15F) v6.01 or after
- GP-330B serial no. 4457-8875 or after
- SC-30
- SC-33
- SCX-20
- Tracks are plotted at very short intervals for five minutes immediately behind your vessel, regardless of the recording interval selected, to give you a more accurate and smooth track.

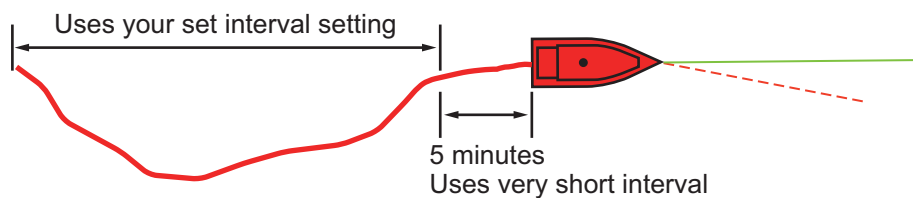

- Track plotting reverts to the selected interval after the five minutes pass, or if recording is stopped within the first five minutes.

For time-based intervals

1. Open the home screen, then tap [Settings]→[Ship & Track].
2. Tap [Track Interval]→[Time], then tap "<" to go back one layer in the menu.
3. Tap [Time Interval].

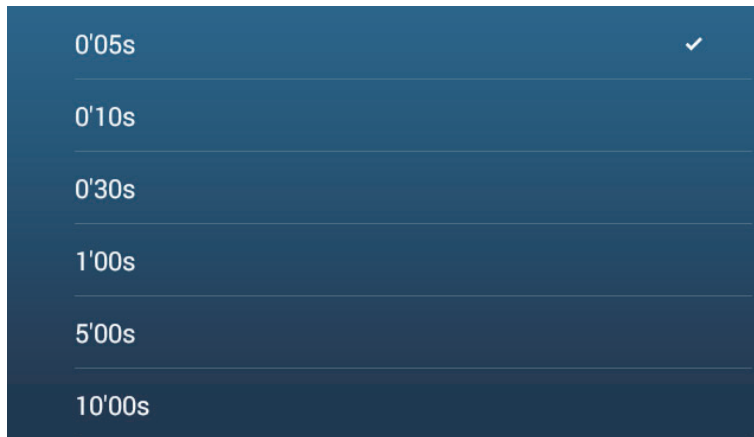

4. Tap a time interval.
5. Tap the close button on the title bar to finish.

For distance-based intervals

1. Open the home screen, then tap [Settings]→[Ship & Track].
2. Tap [Track Interval]→[Distance], then tap "<" to go back one layer in the menu.
3. Tap [Distance Interval]. The software keyboard appears.
4. Input the desired interval, then tap [✓].
5. Tap the close button on the title bar to finish.

2.11.4 Track color

Track can be displayed in a single color or multiple colors. For multiple colors, you can display the track according to one of the conditions shown below.

- Depth
- SST Range
- SST Variation
- Speed
- Bottom Discrimination
- Depth Variation
- Day of Week
- Trip

Note: The bottom discrimination method requires a bottom discrimination capable transducer connected to the bottom discrimination sounder BBDS1, or network sounder DFF1-UHD.

From the home screen

1. Open the home screen, then tap [Settings]→[Ship & Track]→[Track Color].
2. Tap [Fixed] or [Variable]. Tap "<" to go back one layer in the menu. For [Fixed], go to the next step. For [Variable], go to step 5.

3. Tap [Fixed Color Setup] then tap a color. Go to step 10.

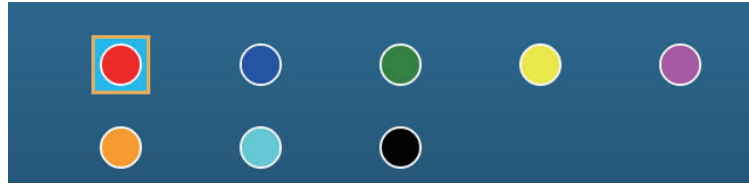

4. Select a color. Go to step 10.
5. Tap [Variable Color] then tap an option.

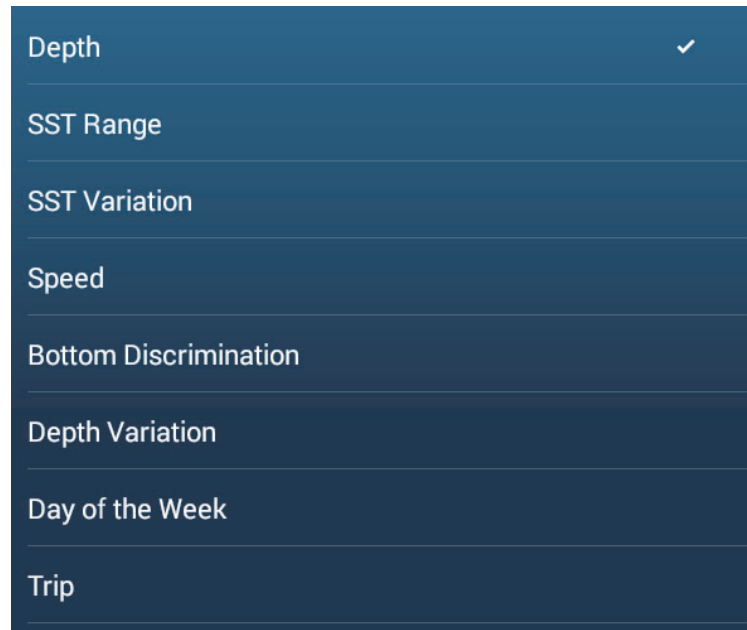

6. Select one of the following, then tap [<] on the title bar to go back one screen.
[Depth]: Change the color of the track with depth.
[SST Range]: Change the color of the track with change in sea surface temperature.
[SST Variation]: Change the color of the track according to variation in sea surface temperature. The following is an example.

Temp. range (°F)	Color	Temp. range (°F)	Color
16.60 to 16.80	Red	17.61 to 17.80	Orange
16.81 to 17.00	Yellow	17.81 to 18.00	Blue
17.01 to 17.20	Green	18.01 to 18.20	Red
17.21 to 17.40	Light-blue	18.21 to 18.40	Yellow
17.41 to 17.60	Purple	18.41 to 18.60	Green

[Speed]: Change the color of the track with speed.

[Bottom Discrimination]: Change the color of the track with bottom sediment.

[Depth Variation]: Change the color of the track with depth variation. The depth at the start of track recording becomes the reference depth.

[Day of the Week]: The track color changes on the specified day of the week.

[Trip]: The color of the track changes in the order of red, blue, green, yellow, purple, orange, cyan. Go to step 10.

Note: In a single voyage (from power on to power off) the track is displayed in a single color. However, if the track recording is started within 4 hours from the end of the previous track recording, the track color will not be changed.

2. CHART PLOTTER

7. Tap [Variable Color Setup].

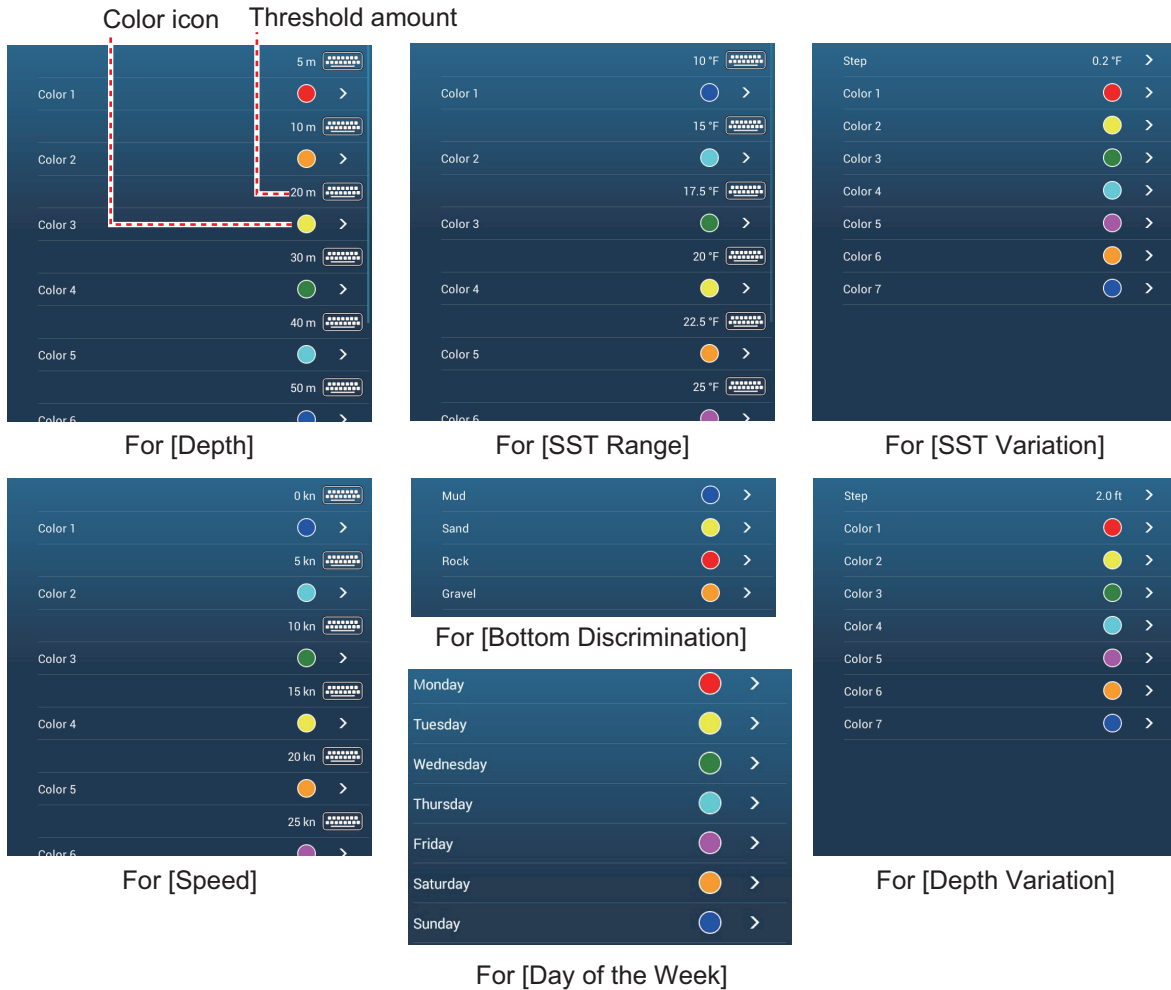

8. **[Bottom Discrimination]:** Tap [Mud], [Sand], [Rock] or [Gravel].
[Day of the Week]: The track color changes on the specified day (Monday to Sunday).
Others: For others, tap a color (seven choices).
 9. Do one of the following depending on your selection at step 6.
 - [Depth]:** Set the color for each depth range. For example, when the red icon is selected in [Color 1], the track is red for depths from 5 to 10 ft.
 - [SST Range]:** Set the color for each range of sea surface temperature. For example, when the blue icon is selected in [Color 1] (temperature range: 10 to 15°F), the track is blue for temperatures from 10 to 15°F.
 - [SST Variation]:** Set the color for each temperature variation. Tap [Step 0.2°F], then set each color. Do the same for [Step 2.0°F].
 - [Speed]:** Set the color for each speed range. For example, when the blue icon is selected in [Color 1], the track is blue for speed from 0 to 5 kn.
 - [Bottom Discrimination]:** Set the color for each bottom sediment. For example, when the blue icon is selected in [Mud], the track where mud is found is blue.
 - [Depth Variation]:** Set the color for each depth variation. Tap [Step 2.0 ft], then set each color. Do the same for [Step 20.0 ft], and [Step 200.0 ft].
 - [Day of the Week]:** Specify the color to paint the track for each day of the week.
- Note 1:** For [Depth] and [Speed] the track is painted in black when respective setting is exceeded.

Note 2: For [Depth], [SST Range], [SST Variation], and [Speed], you can change the threshold amount for each color. Tap a threshold value to display the software keyboard. Set the value, then tap [✓].

10. Tap the close button on the title bar to finish.

On the chart plotter screen

1. Tap a section of track to display the pop-up menu.
2. Tap [Color].
3. Tap a color.

2.11.5 Track thickness

You can set the thickness of the track. If you are following the same track many times, it can be useful to show the track in the thinnest width, to prevent overlapping of track.

1. Open the home screen, then tap [Settings]→[Ship & Track].
2. Drag the slider at [Track Thickness] to set the level. (The thickness can also be set with the software keyboard. Tap the keyboard in the [Track Thickness] field then enter desired thickness.)
A setting of [1] is the thinnest; [4] is the thickest.
3. Tap the close button on the title bar to finish.

2.11.6 How to create a route with past track (follow track)

You can use past track to create a route. The route is saved to the [Routes] list.

1. Tap the past track to use to create a route to show the pop-up menu.

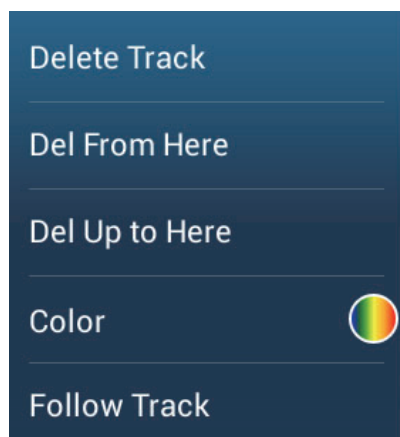

2. Tap [Follow Track].
A route is created with past track. Points are automatically entered and arrows (see "1" in the illustration on the next page) point in the direction of travel.
3. Enter route name, then tap [✓].

2.11.7 How to create a route with track currently being recorded (track back)

You can create a route with track that is currently being recorded. This method can be useful for retracing track; for example, when you need to retrieve crab pots or the like. The route is saved to the [Routes] list.

1. Tap the current track or own ship mark to show the pop-up menu.

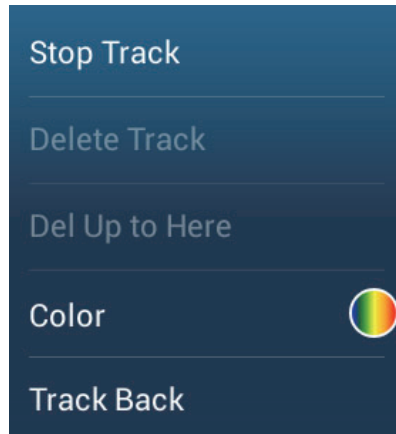

Pop-up menu when track is selected

2. Tap [Track Back].
3. Enter route name, then tap [✓].

A route is then created as shown below.

- Points are created along the route. Arrows on the route point in the direction of travel.
- A thick red dashed line runs between the starting point ("1" in the figure below) and go to point ("2" in the figure below). A solid yellow line shows the shortest distance between current position and go to point.
- Route points are highlighted in yellow.
- Arrival range and cross track error lines are shown.

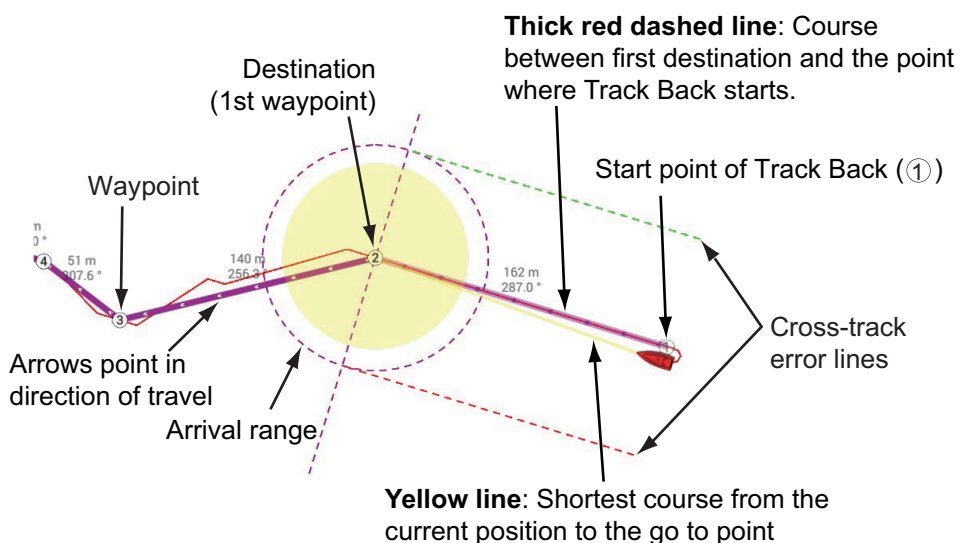

When you are following a track back route, the functions described below are available, from the pop-up menu. Tap the yellow line to display the pop-up menu. For details about each function, see chapter 5.

- **[Stop Nav.]**: Stop following the route.
- **[Restart Nav.]**: Restart following the route.
- **[Insert]**: Insert a waypoint.
- **[Extend]**: Extend a route from the last point on the route.
- **[Name]**: Enter a name for the route.
- **[Rte Detail]**: Open the [Route Detail] list.

2.11.8 How to delete tracks

If the screen becomes full of track, you can not know which is the newer track. Delete the tracks you do not need.

How to delete a single track

Past tracks can be deleted individually. Tap the track, then select [Delete Track] from the pop-up menu.

How to delete a specific part of a track

You can delete a track partially. Tap the part of a track to delete. Tap [Del From Here] or [Delete Up to Here].

How to delete all tracks

1. Open the home screen, then tap [Settings]→[Ship & Track].
2. Tap [Delete All Tracks] on the [TRACK] window. The message "THIS ACTION WILL PERMANENTLY DELETE ALL TRACK..." appears.
3. Tap [OK].
4. Tap the close button on the title bar to finish.

Automatic deleting of tracks

The internal memory stores a maximum of 30,000 track points. When the memory for track points becomes full, the equipment can automatically delete the oldest track points to get space for new track points. To get automatic deletion of track do as follows:

1. Open the home screen, then tap [Settings]→[Ship & Track].
2. Turn [Automatic Track Deleting] on or off.
3. Tap the close button on the title bar to finish.

2.11.9 How to find the number of track points used

On the home screen, tap [Settings]→[General]. Find [Track points] in the [DATA USAGE] section. In the example below, 15,377 track points out of 30,000 have been used.

DATA USAGE	
Points	16 / 30000
Routes	3 / 200
Track Points	15377 / 30000
Boundaries	0 / 100

2.12 Chart Plotter Menu

This section describes the [Chart Plotter] menu items, which are in the [Settings]→[Chart Plotter] menu.

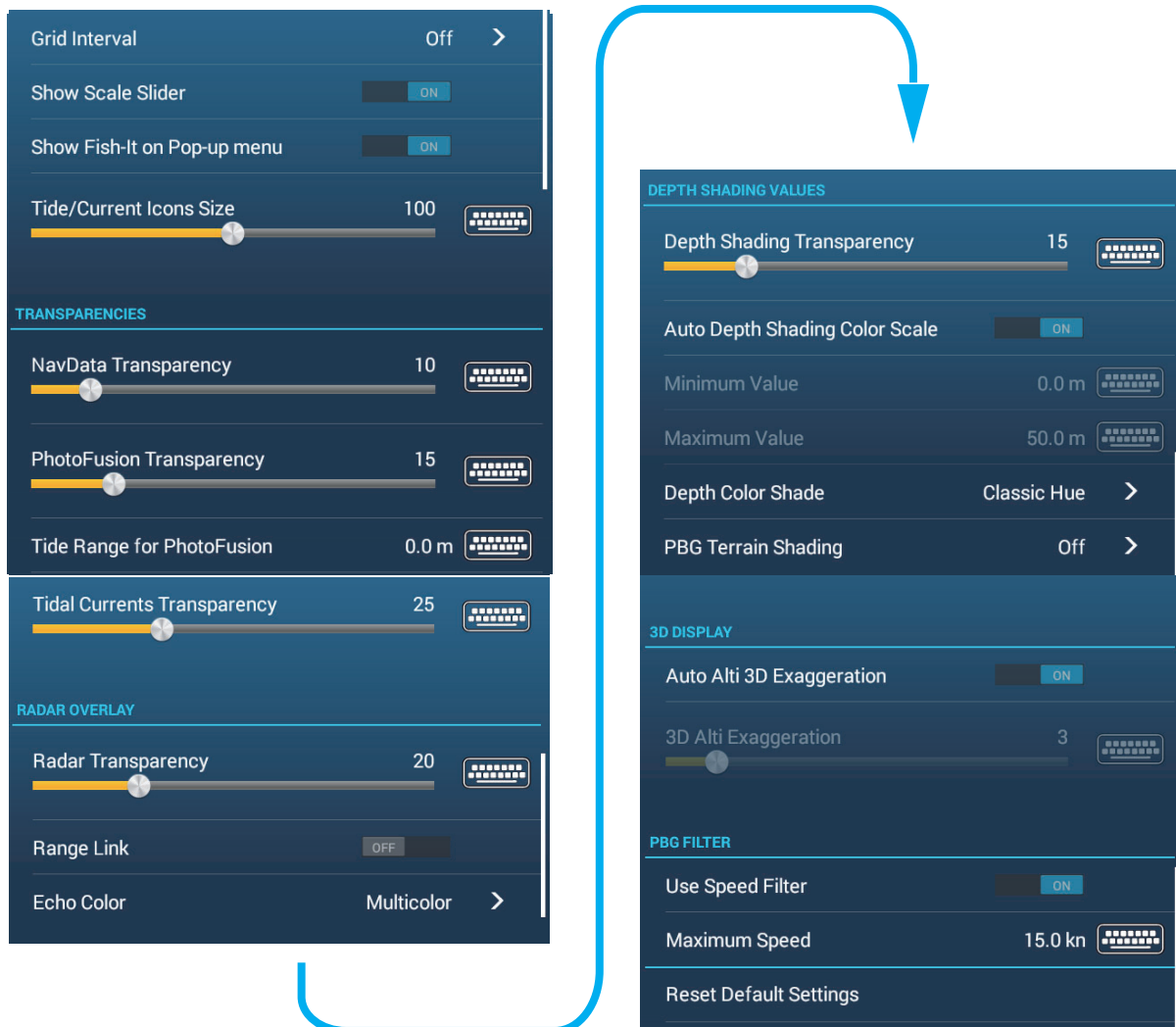

[Grid Interval]: Set the distance between grid lines. The options are [Off] (no lines), [Very Small], [Small], [Medium], [Large], and [Very Large].

[Show Scale Slider]: Show or hide the scale slider.

[Show Fish-it on Pop-up menu]: Select whether to show or hide the [Fish-It] function in the pop-up menu, which appears when you tap a point or event mark on the chart plotter screen. [Fish-It] appears in the pop-up menu even if the catch and ACCU-FISH icons are hidden.

[Tide/Current Icons Size]: Set the size of the icon for tide and current.

[TRANSPARENCIES]

[Nav Data Transparency]: Set the degree of transparency for the navdata display.

[PhotoFusion Transparency]: Set the degree of transparency for the satellite photo overlay.

[Tide Range for PhotoFusion]: Set the degree of transparency for the tide range in the satellite photo overlay.

[Tidal Currents Transparency]: Set the degree of transparency for the tidal currents display.

[RADAR OVERLAY]

[Radar Transparency]: Set the degree of transparency for the radar echo.

[Range Link]: Activate or deactivate matching the overlay with radar ranges.

[Echo Color]: Tap the color for the radar echo.

[DEPTH SHADING VALUES]

[Depth Shading Transparency]: Set the degree of transparency for the depth shading overlay.

For the menu items [Auto Depth Shading Color Scale], [Minimum Value], [Maximum Value], and [Depth Color Shade], see subsection 3.2.1.

[PBG Terrain Shading]: Set the value for PBG terrain shading, Off, Light, Medium, Strong.

[3D DISPLAY]

For [Auto 3D Alti Exaggeration] and [3D Alti Exaggeration], see section 8.7.2.

[PBG FILTER]

[Use Speed Filter]: Enable or disable use of the speed filter. See section 8.7.2.

[Maximum Speed]: Set the ship speed threshold to use when [Use Speed Filter] is activated.

[Reset Default Settings]: Tap this menu item to restore default settings for the [Chart Plotter] menu.

2.13 NAVpilot Series Auto Pilot

This section shows you how to enable use of the NAVpilot with your system. For how to use the NAVpilot to steer to a point, see subsection 4.15.4.

The FURUNO NAVpilot Series Auto Pilot installs in the NavNet TZtouch3 network to get automatic steering when going to a point or a route. The following NAVpilot functions can be controlled from a NavNet TZtouch3 display:

- Control operation of the NAVpilot from this equipment (see subsection 2.13.2).
- Select the NAVpilot steering mode (AUTO or NAV), referring to the NAVpilot's Operator's Manual.
- Set up the NAVpilot (see subsection 2.13.4).

Note 1: When an alarm message for the NAVpilot appears, check the control unit of the NAVpilot.

Note 2: To enter points or routes from your NAVpilot series Auto Pilot, see section 4.15.4 and section 5.11.11.

2.13.1 How to enable use of the NAVpilot

Open the [Settings]→[Routes] menu, then turn on [Navigate with AutoPilot]. When you set a route or point as destination, the message "Do you want to navigate using the NAVpilot?" appears.

If [Alarm Sound when NAVpilot is Engaged] is turned on in the [Alarm] menu, a beep sounds to tell you that the NAVpilot is engaged or disengaged. Note that the beep sounds regardless of the [Alarm Sound] setting.

Note: The following PGN sentences should be turned on (in the [Initial Setup] menu) to enable use of the autopilot with this system.

- 129283: Cross Track Error
- 129284: Navigation Data
- 129285: Navigation - Route/WP Information

2.13.2 How to show the NAVpilot control box in the data area

1. Tap [DATA] or [ROUTE] on the data area to select where to show the NAVpilot control box.
2. Long-tap (single finger) a data box or an unoccupied area to select where to show the NAVpilot control box. The [Edit NavData] menu appears.
3. Tap [Add NavData] to show the available data boxes.
4. Tap [NAVpilot] to show the NAVpilot control box in the area selected.

Note: The example figure below shows the Navpilot data box for the NAVpilot-300 series. The Turn/Menu button () is not shown on the NAVpilot-700 series, however all other indications are the same.

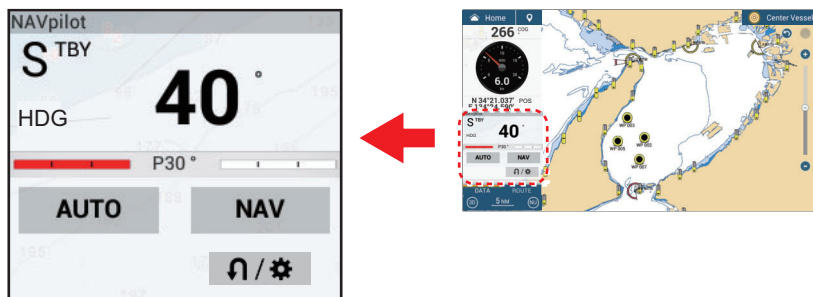

2.13.3 How to change the steering mode

You cannot switch to the window mode (NAVpilot-700 series only) or dodge mode.

Manual (stand-by) mode

The figure below shows an example of the manual (stand-by) mode.

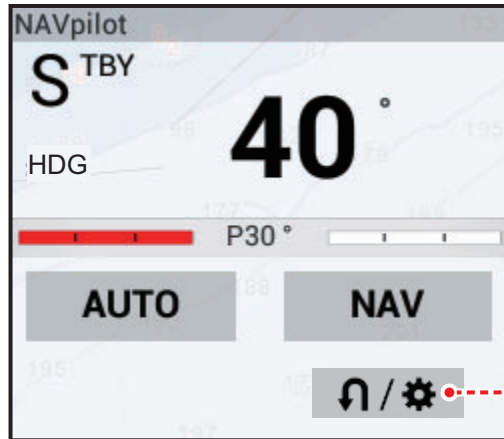

Turn/Menu button
Shown only with connection
of NAVpilot-300.

NAV mode

Tap the manual mode screen to switch to the NAV mode. The figure below shows an example NAV mode data box.

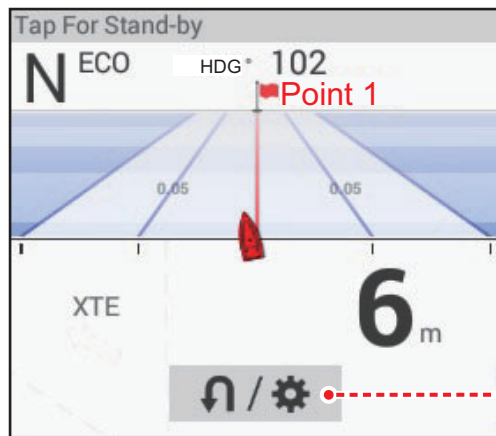

Tap within this area to
switch to the manual
(stand-by) mode.

Turn/Menu button
Shown only with connection
of NAVpilot-300.

AUTO mode

Tap [AUTO] on the manual mode to switch to the NAV mode. The figure below shows an example AUTO mode data box.

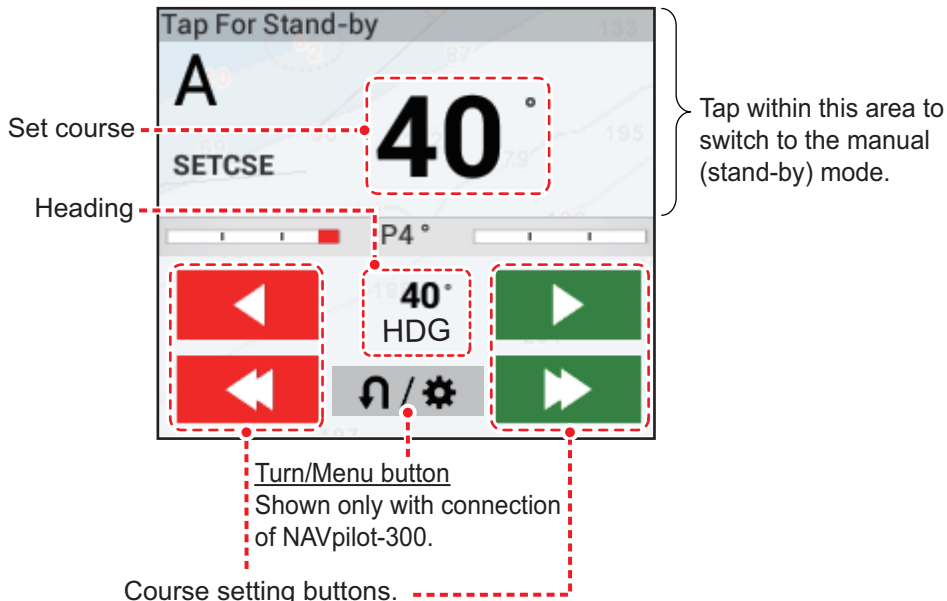

Course setting buttons.
 (Red=Port, Green=STBD)
 Tap the single arrow for fine (1°) adjustments;
 Tap the double arrow for step* adjustment.

* The steering step interval (2 - 30°) can be set with Home icon→[Settings]→[Routes]→[NAVPilot Steering Step]. Use the slider bar or software keyboard.

Do one of the following to set course:

- Use the course setting buttons to set course.
 Tap or for change in 1° increments.
 Use the steering step interval buttons (,) to set course in step intervals.
- Tap the set course line to display the pop-up window shown in the right-hand figure. Tap [Adjust]. Drag the set course line to set course. Tap [Finish] to complete the adjustment.

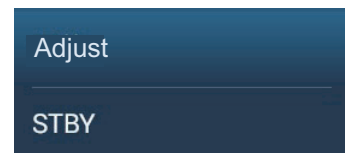

SABIKI mode (NAVpilot-300 only)

1. Tap the Turn/Menu button () in the NAVpilot data box to show the NAVpilot menu.
2. Tap [SABIKI Mode].

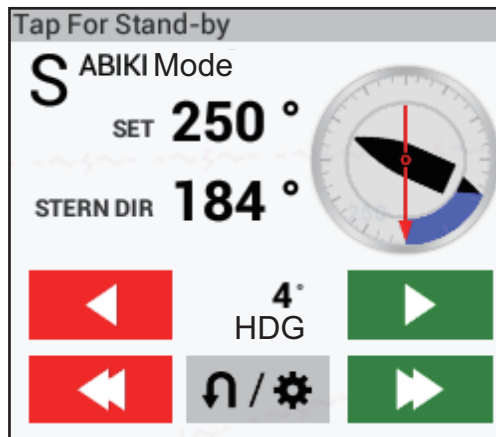

3. Use the set course buttons (see page 2-30) to change your course.

Turn mode. Fishing mode (NAVpilot-300 only)

1. Tap the Turn/Menu button () in the NAVpilot data box to show the NAVpilot menu.
2. Tap desired turn type. See the Operator's Manual for the NAVpilot-300 for details.

2.13.4 How to change the NAVpilot settings

1. Tap the Turn/Menu button () in the NAVpilot data box to show the NAVpilot menu.
2. Tap [NAVpilot Settings] to show the NAVpilot settings menu. (Alternatively, the screen shown below can be displayed by tapping Home icon→[Settings]→[Initial Setup]→[NAVpilot-300(Processor)]...)

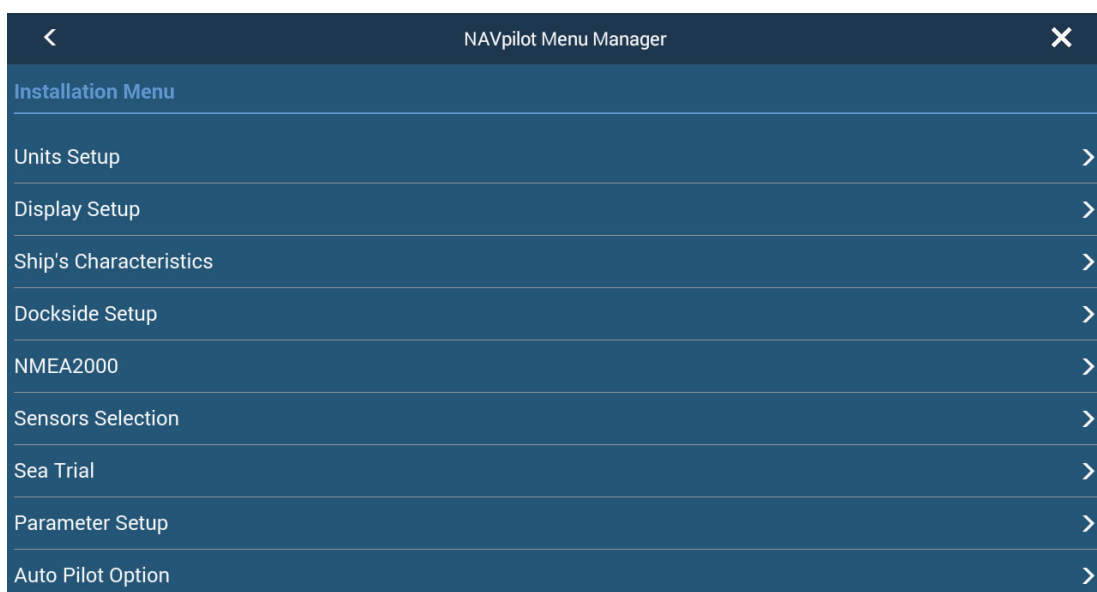

3. Change the settings as required, referring to the NAVpilot operator's manual.

2.14 TZ iBoat

The TZ iBoat application provides a basic map (open street map). The application has the following features:

- Plot your position in real-time on a basic map or satellite picture (internet access required for streaming basic map and satellite photos) using your device's internal GPS, Bluetooth GPS or NMEA0183 Wireless Gateway.
- Navigation in 2D or 3D perspective
- Route planning
- Trail and track recording
- Sensor compatibility to display additional real-time information (heading, depth, wind and sea surface temperature) when connected to a NMEA0183 Wireless Gateway.
- Real-time local weather and weather trends
- Unlimited GFS weather forecasts
- Tides and currents database

2.15 TZ First Mate

TZ First Mate™ is a smartphone, tablet fishing record application. You can record photos of catches, types of catches, fish lengths, and fish weights of the fish you catch. By logging in to My TimeZero™, you can share photos and fishing data between the TZ FirstMate™ application and NavNet TZtouch3.

Note 1: See section 1.20 for how to login to your My TimeZero™ account.

Note 2: Before opening the application, connect your smartphone, tablet with your wireless LAN network (see section 1.19).

How to register catches

Catches (see "Method 5: Log Catch" on page 4-4 for information) can only be entered from your NavNet TZtouch3.

How to share photos

Photos taken with your smartphone, tablet can be shared with your NavNet TZtouch3 and displayed on the chart plotter screen. The photo location is shown on the chart plotter screen with the photo icon ().

2.16 Photos

Screen-captured images and photos taken with the smartphone/tablet application TZ First Mate™ can be shown on the chart plotter display. See section 2.14.

Note: Before opening the application, connect your smartphone/tablet with your wireless LAN network (see section 1.19).

How to import photos

See section 9.3 for how to import photos. Imported photos appear on your plotter screen with the photo icon ().

You can check how many photos are stored on your NavNet TZtouch3. Go to the home screen, then select [Settings]→[General], then scroll the menu to show the [Data Usage] section.

DATA USAGE	
Points	63 / 30000
Routes	3 / 200
Areas & Lines	0 / 100
Circles	0 / 100
Photos	5 / 1000
Catches	18 / 1000
Track Points	0 / 30000
Reset Default Settings	

At the [Photos] line, “currently saved photos” / “total available photo storage” indicates the total number of photos versus the total available space for photos. In the following example, a total of five photos are stored.

How to move a photo on-screen

1. Tap the photo you want to move, then select “Move” from the displayed pop-up menu. The move icon appears at the selected photo location, similar to the figure shown to the right.
2. Drag and drop the icon to the new location, or tap the new location on-screen.
3. Tap [End Move] at the top-right corner of the screen.



2. CHART PLOTTER

How to show the Photos list

From the home screen, tap [Lists]→[Photos] to show the [Photos] list.

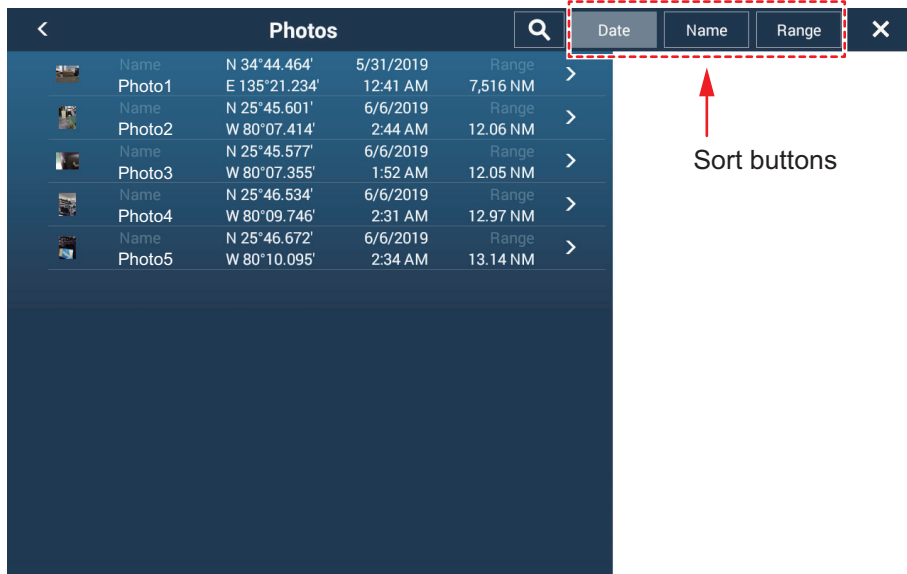

To sort or search the list, see section 4.7.

How to edit photo information

You can edit photo information from the editing screen.

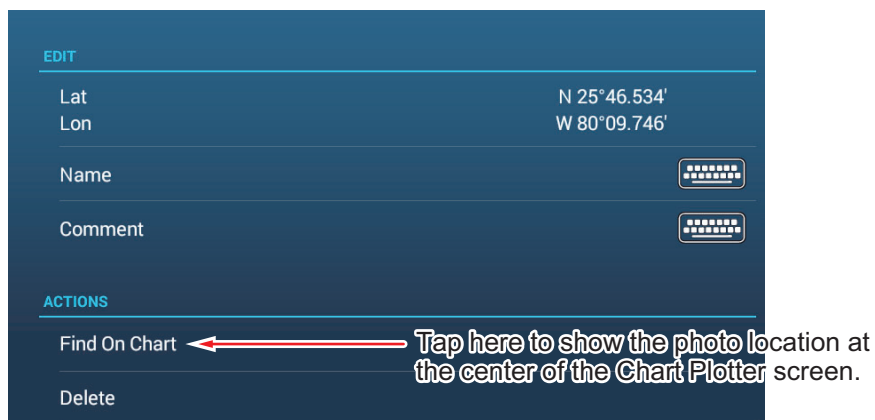

Editing is done with one of the following methods:

- Tap the photo icon to show the pop-up menu, then select [Edit].
- Select the photo you want to edit from the [Photos] list.

Referring to section 4.10.1, edit the coordinates, name and comment of the photo as required.



How to delete photos via the menu

You can delete photos with one of the methods:

- **Individual photo, pop-up menu:** Tap the photo icon to show the pop-up menu, then select [Delete].
- **Individual photo, via menu:** Select [Delete] from the [Edit] menu.
- **Delete all photos, via menu:** From the home screen tap [Settings]→[Points & Boundaries]→[Delete All User Objects]→[OK]. (See section 4.9.4 and section 5.7.4.)

How to delete photos collectively via the Photos list

1. On the Home screen, tap [Lists]→[Photos] to show the [Photos] list.
2. At the top of the [Photos] list, choose how to sort the photos.
3. Tap the  icon. In the example list below the photos are sorted by name.



	Name	Coordinates	Date	Range	
<input checked="" type="checkbox"/>	TZT3Scree...	N 27°03.382' W 84°53.412'	1/1/2018 12:02 PM	1,278 NM	>
<input type="checkbox"/>	TZT3Scree...	N 27°03.382' W 84°53.238'	1/1/2018 12:02 PM	1,278 NM	>
<input type="checkbox"/>	TZT3Scree...	N 27°03.382' W 84°51.926'	1/1/2018 12:04 PM	1,276 NM	>
<input type="checkbox"/>	TZT3Scree...	N 27°03.382' W 84°51.721'	1/1/2018 12:04 PM	1,276 NM	>
<input type="checkbox"/>	TZT3Scree...	N 27°03.382' W 84°49.017'	1/1/2018 12:07 PM	1,274 NM	>
<input type="checkbox"/>	TZT3Scree...	N 27°03.382' W 84°48.890'	1/1/2018 12:07 PM	1,274 NM	>
<input type="checkbox"/>	TZT3Scree...	N 27°19.921' W 60°52.132'	1/1/2018 12:11 PM	6,181 NM	>
<input type="checkbox"/>	TZT3Scree...	N 27°19.921' W 60°39.981'	1/1/2018 12:24 PM	16.99 NM	>
<input type="checkbox"/>	TZT3Scree...	N 47°38.422' W 122°25.632'	1/1/2018 12:26 PM	3,144 NM	>
<input type="checkbox"/>	TZT3Scree...	N 27°21.397'	1/1/2018	Range	>

4. Put a checkmark (✓) in the checkbox of the photo to delete, or check a sort title to delete all photos within that title. For example, in the [Photos] list above, check “T” to delete all photos whose name begins with “T”.
5. On the title bar, tap [Delete Checked Items]. A message asks if you are sure to delete checked photos. Tap [OK] to delete the photos.

Like with points you can delete log catches from the [Catches] list.

2.17 Fleet Tracking

The fleet tracking function, which requires internet connection, lets you see the status (position, speed, etc.) and user objects (points, routes, boundaries, photos, catch log, etc.) of ships belonging to the same fleet tracking group as own ship.

Note 1: To use this feature, you need to create a My Time Zero™ account (see section 1.20) and register fellow sister ships in the same fleet.

Note 2: Only PCs with Time Zero™ Professional version 4.1 or later can send user object data to sister ships in the same fleet.

Note 3: To display the MMSI and boat name in the information, set the MMSI and boat name in the [Boat Information] menu of the [Initial Setup] menu. See the Installation Manual for details. If connected to the FA-30/40/50 AIS Transponder, the MMSI and boat name are automatically displayed in the above-mentioned menu.

2.17.1 How to set up fleet tracking

1. From the Home screen, tap [Settings]→[General].
2. Set [Report Position to My TIMEZERO] to [ON].
3. Tap [Report Interval], then set how often to report your boat's information to the fleet tracking system.
4. Tap [×] close the menu.

2.17.2 How to show/hide fleet target (sister ship) symbols

Open the Layers menu, then set [Fleet Targets] to [ON] to show fleet targets, or [OFF] to hide them. The figure below shows the appearance of the fleet target symbol.



2.17.3 How to show fleet target information

Tap a fleet target symbol to show the target's basic information, in the pop-up menu. For detailed information, tap [Info] on the pop-up menu.

Name	yuki fukushima
COG	0.0 °
SOG	0.0 kn
Range	43.84 NM
Bearing	62.1 °
CPA	5.377 NM
TCPA	7h16'
Last Update	-***d
Info	
Reset Target	

Basic Information

Target Info	
Nickname	[Edit Icon]
Color	[Color Picker]
Boat Name	
MMSI	
COG	0.0 °
SOG	0.0 kn
Depth	79.1 m
Wind Speed	— kn
Wind Dir.	— °
Range	43.81 NM
Bearing	62 °
Vessel Length	12.2 m
Vessel Width	3.05 m

Detailed Information

2.17.4 How to clear fleet target symbols temporarily from the screen

You can temporarily clear any fleet target from the chart plotter screen and fleet target list (see section 2.17.5) until new information is received, at the interval set with [Report Interval] in the [General] menu. Tap the fleet target you want to delete to open the pop-up menu, then tap [Reset Target].

2.17.5 Fleet target list

Fleet target information is stored in the [Fleet] list. You can check and edit the information of consort ships. The [Fleet] list stores the following data for each fleet target:

- Nickname
- Color of fleet target
- Boat's name
- MMSI
- COG/SOG
- Depth
- Wind speed and direction
- Range and bearing to own ship
- Ship's length and width
- Position (latitude and longitude)
- User name (My TimeZero™ login name)
- Time and date of data update
- Date

1. From the Home screen, tap [Lists]→[Fleet] to show the Fleet list.

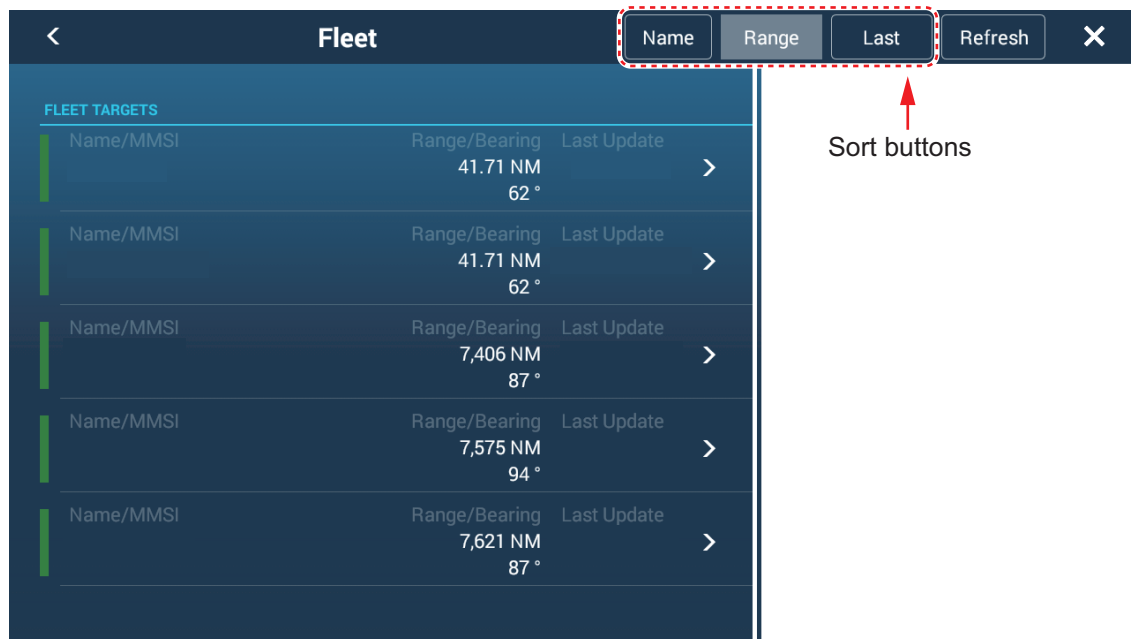

2. To sort or search the list, follow the applicable procedure below.

How to sort the Fleet list

Tap the appropriate sort button on the title bar.

[Name]: Sort the list in alphabet order.

[Range]: Sort the list in ascending order by distance from own ship.

[Last]: Sort the list by latest update.

How to search the Fleet list

You can search the list by alphabet.

- a) Tap [Name] on the [Fleet] list.
- b) Tap the alphabet of each fleet target.

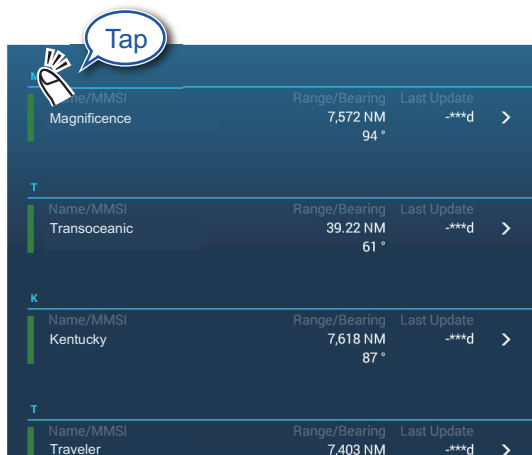

The search screen appears, and the searchable alphabets are displayed in blue.

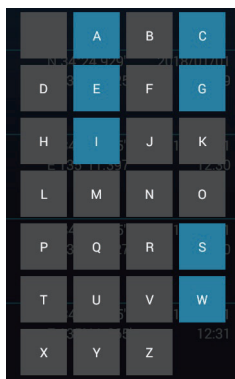

3. Tap the fleet target to check or edit.

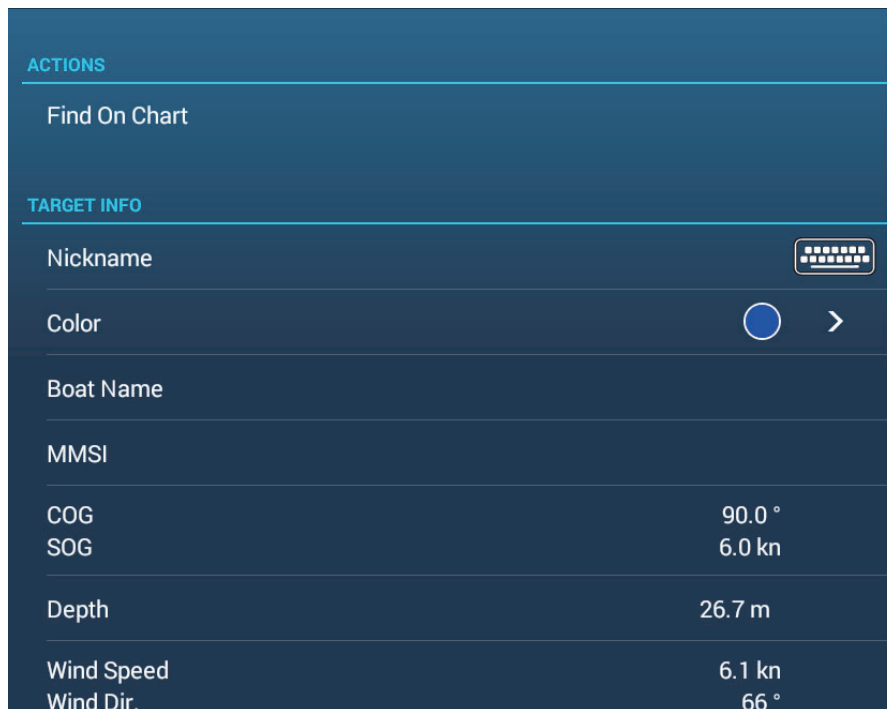

4. To edit a fleet target, follow the appropriate procedure below.

Edit a nickname

- 1) Tap the letter to change in a nickname.
- 2) Use the software keyboard to edit the nickname.
- 3) Repeat steps 1) and 2) to continued editing. A nickname can have a maximum of 32 characters.
- 4) Tap [×] to finish.

Change the color of a fleet target symbol

- 1) Tap [Color].
- 2) Select a color than tap [<] to go back one layer.
- 3) Repeat steps 1) and 2) to continued editing. A nickname can have a maximum of 32 characters.
- 4) Tap [×] on the title bar to close the editing window.

2.17.6 How to put a fleet target at the center of the chart plotter screen

Tap the fleet target that you want to put at the center of the screen. Tap [Find on Chart] to put the target at the center of the screen.

2.17.7 How to share user objects

When you receive a user object from a fleet target, the message "Fleet: user Object received from..." appears.

Note: You can receive a maximum of 92 user objects. See section 9.2 for details.

2.18 Fish-It

The [Fish-It] function is used to start drift fishing aiming at a specific point such as the ACCU-FISH icon (see section 7.14) or a log catch icon (see section 4.2.2). Since you can see information such as the distance and direction to the target point, it is convenient when you are fishing with the engine off.

Note: The [Fish-it] calculation does not consider obstacles in the drift path. Be careful of any obstacles within the drift path.

How to show the Fish-It item in the pop-up menu

The [Fish-It] item is shown in the pop-up menu whenever you tap your boat's track, point, event mark (log catch), or ACCU-FISH™ icon. Do as follows to activate the [Fish-It] item. Note that [Fish-It] appears in the pop-up menu even if the catch and ACCU-FISH icons are hidden

1. From the Home screen, tap [Settings]→[Chart Plotter].
2. Set [Show Fish-It on Pop-up menu] to [ON].
3. Tap [x] on the title bar to close the menu.

Lat	N 34°44.054'
Lon	E 135°21.494'
Range	26.34 NM
Bearing	58.5 °
Goto	
Fish-It	

For point

How to use Fish-It

1. On the chart plotter screen, tap the location (point, etc.) where you want to fish. The pop-up menu appears.
2. Tap [Fish-It].
Range rings appear, centered on the own ship icon. The waypoint is marked with

the  icon, and own ship and the waypoint are connected with a solid yellow line. Also, ship's track is shown.

Note: The maximum radius of the range ring depends on the setting for [Short/Long Changeover] in the [Units] menu.

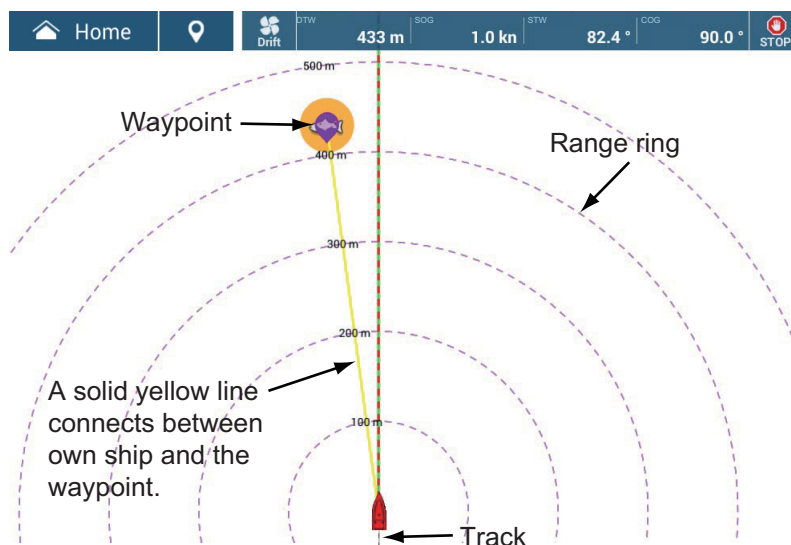

3. Before activating the drift function, cut your engines and wait until forward momentum has subsided. Then, tap the [Drift-It] icon () on the navigation bar to activate the drift function. (If engine(s) are not turned off before tapping the icon, a message asks you to turn off your engine(s).) Note that you can also use the pop-

up menu to activate the drift function. Tap the fish icon or yellow line to show the pop-up menu, then tap [Start Drifting].

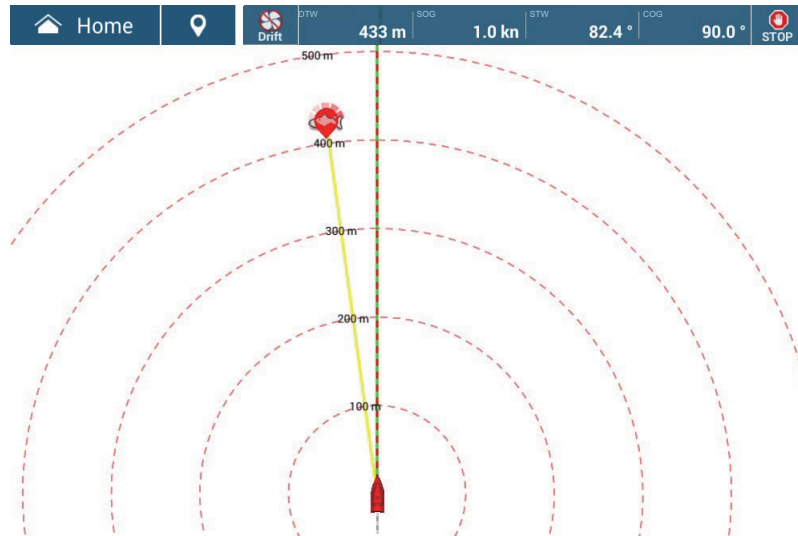

When the engine is off, the ship drifts under the influence of wind and tides, making it difficult to reach its destination. With the Drift function, drift data is accumulated while it is on, and when deactivated after a few minutes, the purple icon indicates from which point to start drift fishing based on the accumulated drift information.

- After a few minutes, tap the [Drift-It] icon () to deactivate the drift function. Tap the fish icon or yellow line to show the pop-up menu, then tap [Stop Drifting] to deactivate the drift function. A purple icon appears adjacent to the yellow line. This icon indicates from which point you should start drift fishing next.

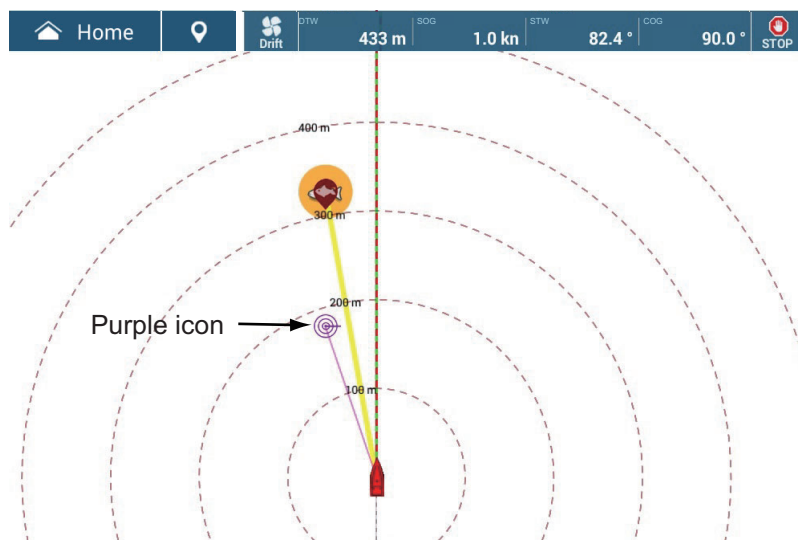

2. CHART PLOTTER

5. Tap the purple icon. A pop-up similar to the one shown below appears.

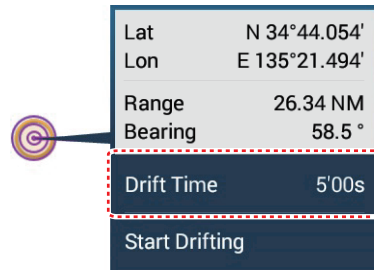

6. Tap [Drift Time], then select desired drift interval, among 3'00s, 5'00s, 10'00s, 15'00s, and 20'00s.
If necessary, repeat steps 3 to 6.
7. To deactivate the [Fish-It] function, tap the [STOP] icon on the navigation bar.
The [Fish-It] function can also be deactivated from the pop-up menu. Tap the fish icon or the yellow line, then tap [Stop Fish-It] on the pop-up menu.

3. 3D DISPLAY, OVERLAYS

3.1 3D Display

The 3D display has native 3D chart design that allows full time 3D presentation. This true 3D environment gives you all of the information you require with no restrictions on the information you can see. You can plan your routes, enter points, etc. like on the 2D chart.

The 3D display provides a 3D view of land and sea around your ship. The 3D display has most of the same information as the 2D display. With both presentations available you can see the conditions around your ship from different angles. The 3D display helps you navigate when you are in waters that you do not know. Also, most functions of the 2D display, for example, destination setting, are available in the 3D display.

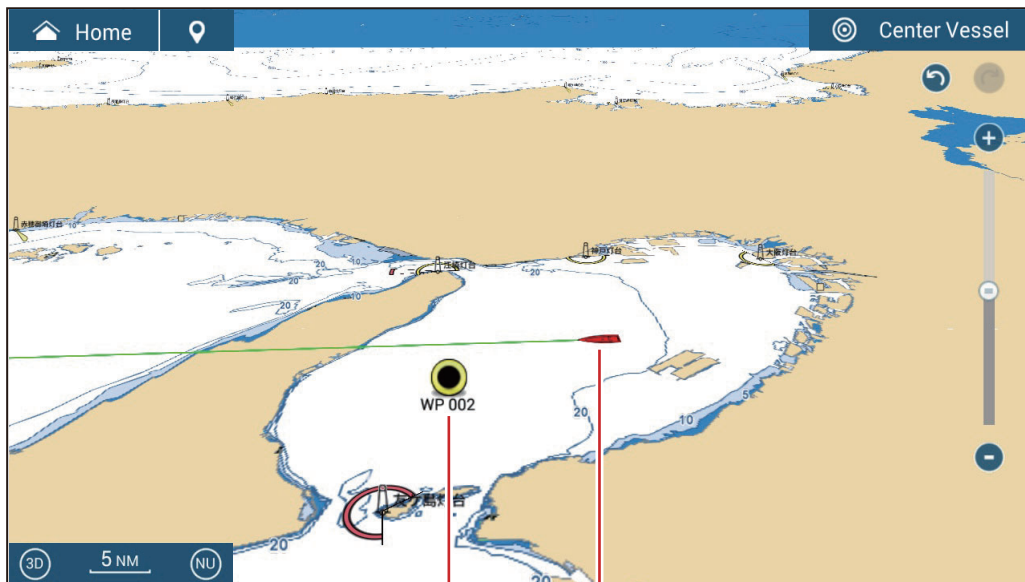

Point
Own ship icon
(your ship)

3D display

3.1.1 How to activate the 3D display

1. To switch between the 2D and 3D displays, tap the 2D/3D switch at the bottom left corner on the screen or drag upward/downwards as shown below. The icon is filled in white when the 3D display is active.

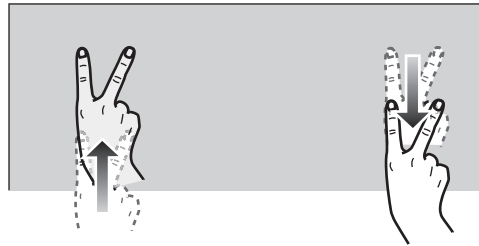

Drag upwards: 2D→3D Drag downwards: 3D→2D

2. Tap the orientation mode switch to select an orientation mode.
3. Orientate the 3D display by dragging leftward or rightward with two fingers.

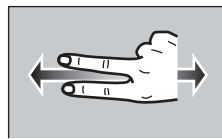

The 2D/3D display switch, orientation mode switch

The 2D/3D display switch alternates the 2D and 3D displays. The orientation mode switch selects the orientation, North up or Head up. In the North up mode, North is at 0°. When you change the viewpoint on the 3D display, the orientation mode switch shows the "North" icon. The arrow on the icon points toward North. To switch to North-up orientation, tap the switch.

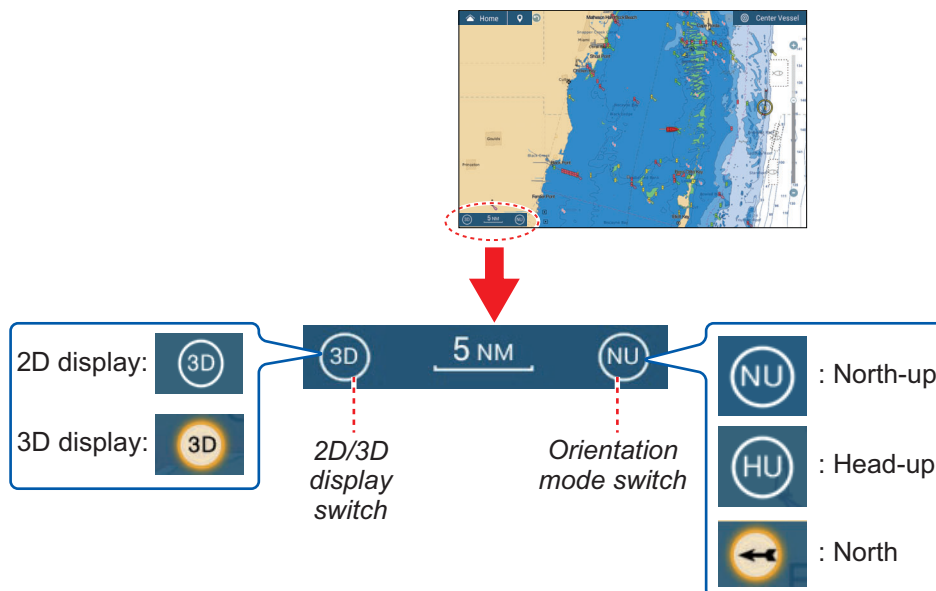

3.1.2 How to make the 3D view clearer

In the 3D view, the features of the terrain can be more easily recognized by using the emphasis function. The emphasis function has two settings, automatic and manual. Select one following the procedure below.

1. Go to the Home screen, then tap [Settings]→[Chart Plotter].
2. Find the [3D DISPLAY] section.

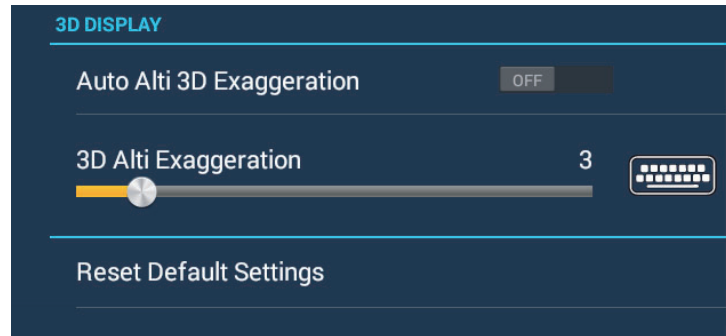

3. Automatic method:
Turn on [Auto Alti 3D Exaggeration].
Manual method:
Turn off [Auto Alti 3D Exaggeration]. Use the slider or software keyboard at [3D Alti Exaggeration] to set the exaggeration level.
High gives the highest level of exaggeration. The example below compares the same picture in low and high exaggerations.



Low exaggeration

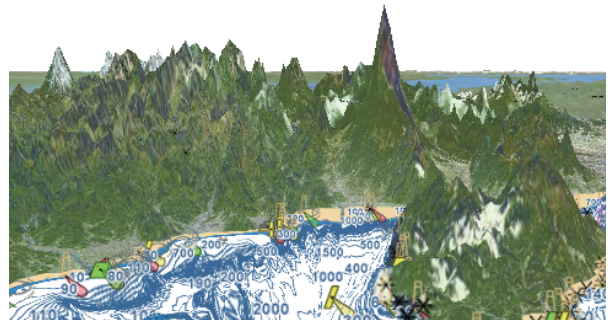

High exaggeration

4. Tap the close button on the title bar to finish.

3.2 Overlays

Five overlays are available for the chart plotter display: depth shading, satellite, radar, tide information, ACCU-FISH™ icon, and tidal current.

3.2.1 Depth shading overlay

The depth shading overlay shows the depths in different color (the default settings are red (shallow), yellow (medium) and blue (deep)). This overlay is available in both 2D and 3D presentations. Use this overlay to find depths. To show the depth shading overlay, open the Layers menu then turn [Depth Shading] on or off.

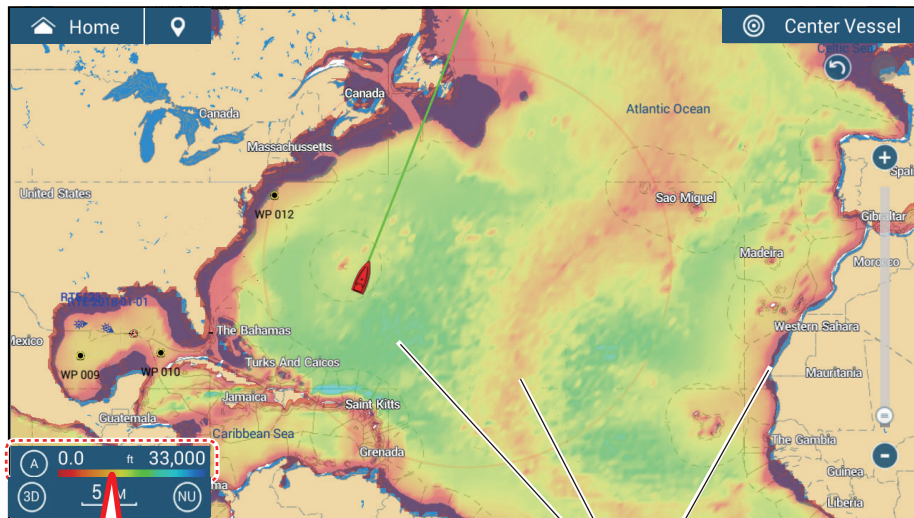

Depth shading

Minimum value
Maximum value

Manual mode



Auto mode

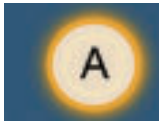



You can turn the automatic depth shading color scale adjustment on or off (auto, manual) by tapping the “A”.

Automatic mode:
Depth shading is set according to the depth shading values set in the menu (Settings→Plotter).

Manual mode:

- 1) Tap the minimum value (maximum value) at left side (right side) of scale.
- 2) Drag the slider bar at right side of screen to set value.
- 3) Tap [Done] to complete.

Depth shading settings

The depth shading settings are in the [Settings]→[Chart Plotter] menu.



[Depth Shading Transparency]: Adjust the degree of transparency of the depth shading overlay.

[Auto Depth Shading Color Scale]: Turn automatic depth shading color scale selection on or off.

[Minimum Value]: Set the minimum depth range for which to show depth shading, with the software keyboard. This is available when [Auto Depth Shading Color Scale] is set to [OFF].

[Maximum Value]: Set the maximum depth range for which to show depth shading, with the software keyboard. This is available when [Auto Depth Shading Color Scale] is set to [OFF].

[Depth Color Shade]: Select how to display the depth colors among [Classic Hue], [Inverted Classic Hue], [Red Hue], [Blue Hue], [Green Hue] and [Yellow Hue].

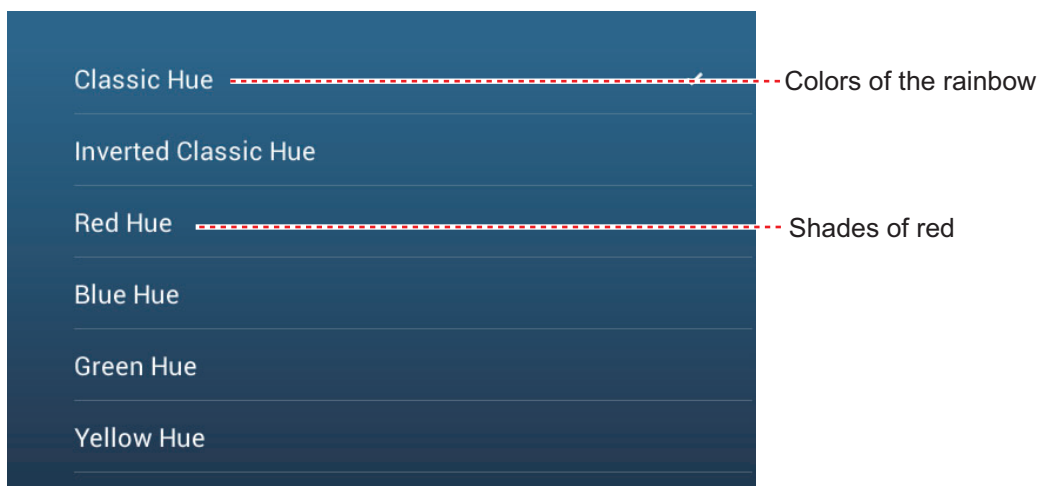

[PBG Terrain Shading]: Set the degree of shading to use on the PBG recordings. See section 8.7.3.

3.2.2 Satellite photo overlay

You can put the satellite photo for your area on the 2D and 3D displays. Open the Layers menu then turn [Satellite Photo] on or off.

High resolution satellite images for the USA coastline are not provided standard, but are available online for download at no cost. The illustration below shows the vector chart with the satellite photo overlay.

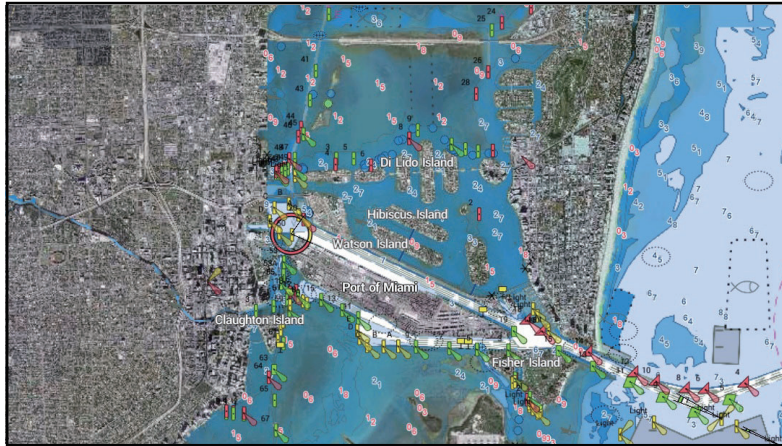

How to set satellite photo transparency on water

You can set the degree of transparency for the satellite photo on the water.

1. Go to the Home screen, then tap [Settings]→[Chart Plotter].
2. Find the [TRANSPARENCIES] menu, then drag the slider at [PhotoFusion Transparency] to set the level (setting range: 0% to 80%).
3. Tap the close button on the title bar to finish.

3.2.3 Radar overlay

The radar overlay display puts the radar picture on the top of the navigation chart. To display the radar overlay, open the Layers menu, then turn on [Radar Overlay].

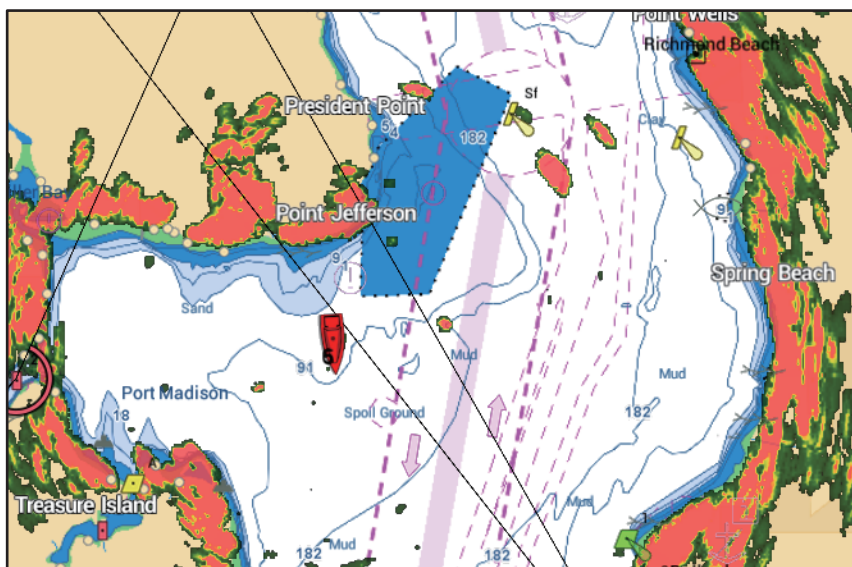

How to switch between stand-by and TX sync overlay and radar ranges

Switch between stand-by and TX: Tap the [TX] icon at the bottom-left corner to set the radar in transmit or stand-by state. The icon is filled in white when the radar is transmitting; blue in stand-by.

Sync overlay and radar ranges: Open the Home screen, tap [Settings]→[Chart Plotter], then turn [Range Link] ON or OFF as appropriate. With [Range Link] turned off you can sync the ranges manually, with the Sync icon at the bottom-left corner.

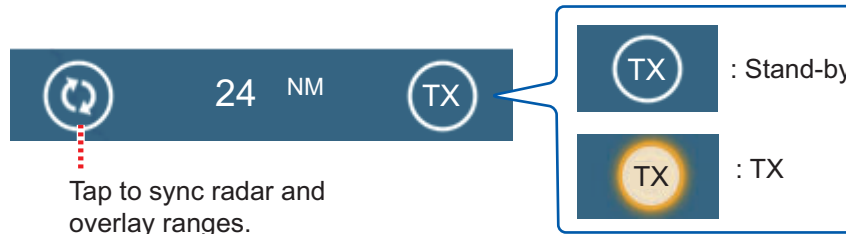

How to set the level of the radar echo transparency

Go to the Home screen, then tap [Settings]→[Chart Plotter]. Find the [TRANSPARENCIES] menu, then drag the slider at [Radar Transparency] to set the transparency level.

How to adjust radar gain, sea, rain

The gain and sea and rain clutters can be adjusted from the navigation data display. See sections 6.3 - 6.5.

How to select the echo color

Go to the Home screen, then tap [Settings]→[Chart Plotter]→[Echo Color] ([RADAR OVERLAY] menu). Tap [Multicolor], [Green], or [Yellow].

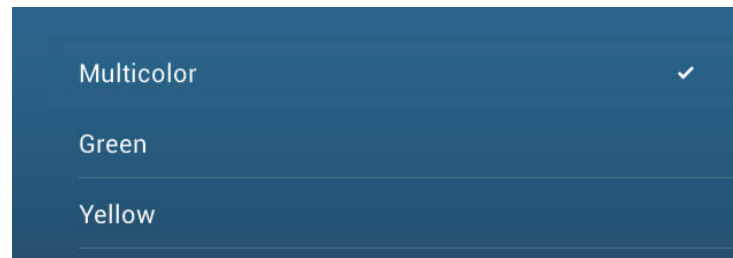

How to acquire a target for ARPA

A target can be acquired for ARPA. See subsection 6.25.2.

Note: The radar picture can look "out of focus" on long ranges when the range link is active. This out of focus appearance does not indicate a problem, because it is a characteristic of the digital zoom.

3. 3D DISPLAY, OVERLAYS

3.2.4 Tide info overlay

Your system carries worldwide tide information, shown with tide icons, which you can overlay on the chart plotter display. The tide icon (📏) appears at the locations of tidal recording stations.

How to display the tide info overlay

Open the Layers menu, then tap [Tide Heights].

The arrow on the tide icon points upward or downward with tide direction. The tide icon is gray and yellow according to the tide state. The tide icon is all yellow when the tide is high completely and all gray when the tide is low completely.

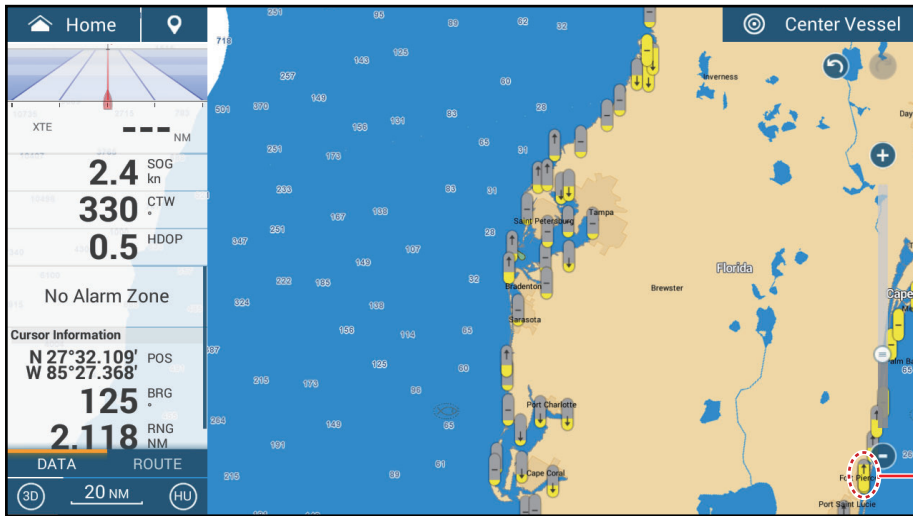

Tide icon (yellow and/or gray)

- ↑ : Up arrow indicates the tide is going high.
- ↓ : Down arrow indicates the tide is going low.
- : No arrow indicates no change in tide.

How to change the size of the tide icon

1. Go to the Home screen, then tap [Settings]→[Chart Plotter].
2. Drag the slider at [Tide/Current Icons Size] to set size (setting range: 50% to 150%).
3. Tap the close button on the title bar to finish.

How to show the tide information

Tap a tide icon to display the tide height graphic in a pop-up window, an example of which is show in the right figure.

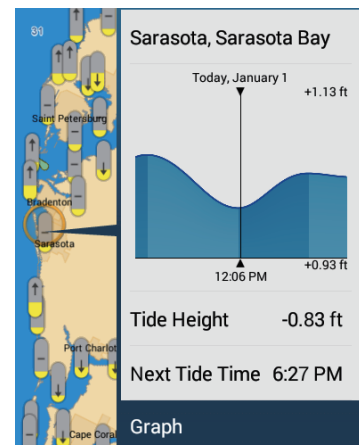

How to display the tide graph

- **Display tide graph for a tide station:** Tap a tide icon then tap the pop-up window.
- **Display tide graph for the tide station nearest the selected position:** Tap the desired position on the chart, then tap [Info]. If a tide station is not within 35 NM of the location tapped, the tide graph does not appear.
- **Display tide graph for the tide station nearest current position:** Open the Slide-out menu or the Home screen, then tap [Tide].

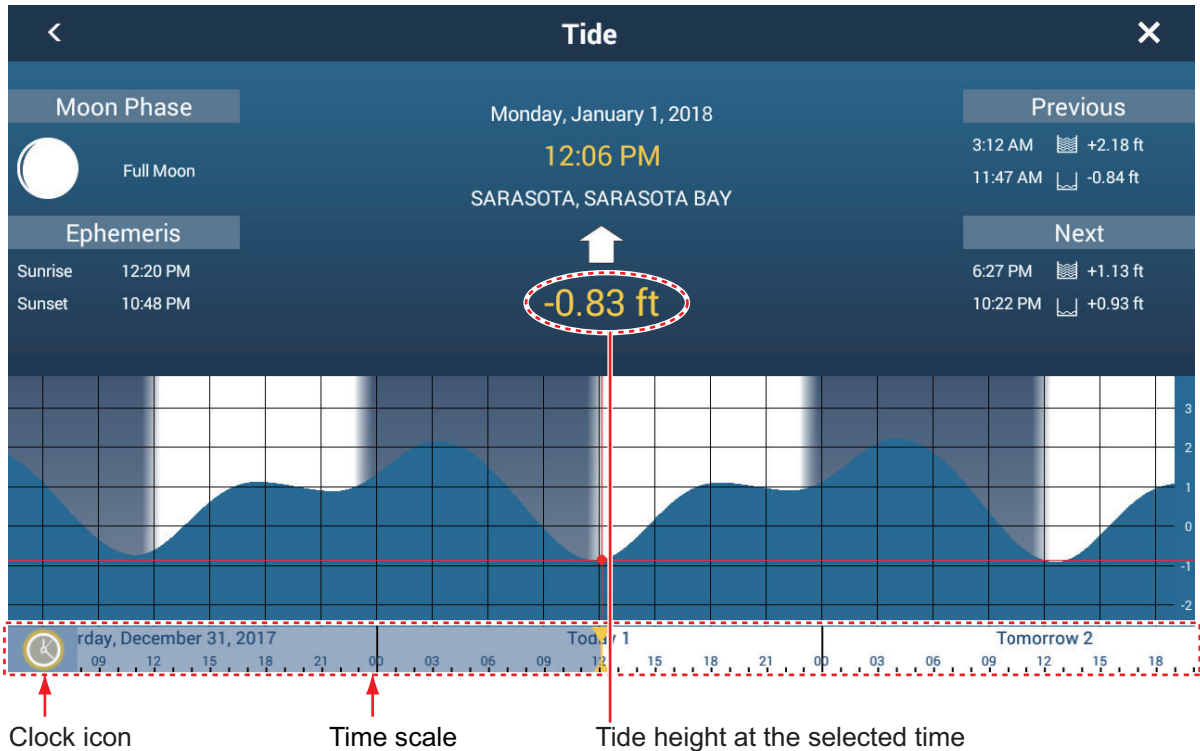

How to read the tide graph

- Vertical axis: Height, Horizontal axis: Time
- The information is mostly accurate under moderate weather conditions. However, storms and weather fronts can influence forecasted tide times and heights.
- Drag the time scale at the bottom of the screen sideways then read the tide height at the selected time (drag to the left to display the future information, right for the past information).
- To set the time scale to the current time, tap the clock icon at the bottom left-hand corner of the screen. The color of the clock mark turns gold.



Clock icon for the current time



Clock icon other than the current time

- To exit the screen, tap the close button.

How to display the tidal current graph

Tap a tidal current icon to display the pop-up window. Tap [Graph] on the pop-up window to show the [Current] graph window

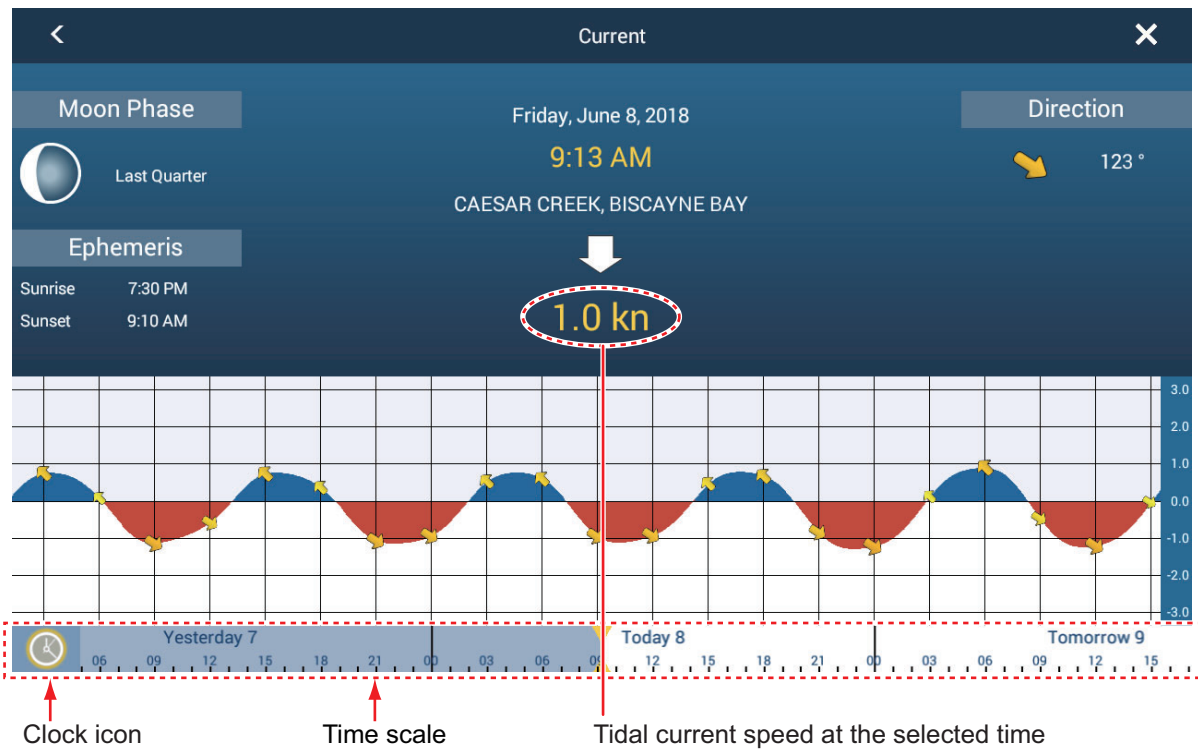

About the tidal current graph

- The vertical axis is the speed of the current; the horizontal axis is the time of the current.
- The information is mostly accurate under moderate weather conditions. However, storms and weather fronts can influence forecasted tidal current directions and speeds.
- To see tidal current speed at a selected time, drag the time scale at the bottom of the screen sideways then read the tidal current speed at the selected time. Drag to the left to display the future information, right for the past information.
- To set the time scale to the current time, tap the clock icon at the bottom left-hand corner of the screen to show the clock mark in yellow-white.



Clock icon for the current time



Clock icon other than the current time

- To return to the chart plotter display, tap the Close icon at the top-right-corner of the screen.

3.2.6 How to show the ACCU-FISH icon on the overlay

The ACCU-FISH icon can be shown on the chart plotter display. Requires an ACCU-FISH™ compatible transducer (see Appendix 2) and applicable network sounder (DFF series, BBDS1).

To show the ACCU-FISH icon on the chart plotter display, open the Layers menu, then set [ACCU-FISH] to [ON]. Select [OFF] to remove the icon from the chart plotter display.

Note: Control of the ACCU-FISH icon on the chart plotter display can always be done through the Layers menu, regardless of the [ACCU-FISH] setting (see section 7.14.3) on the [Fish Finder] menu.

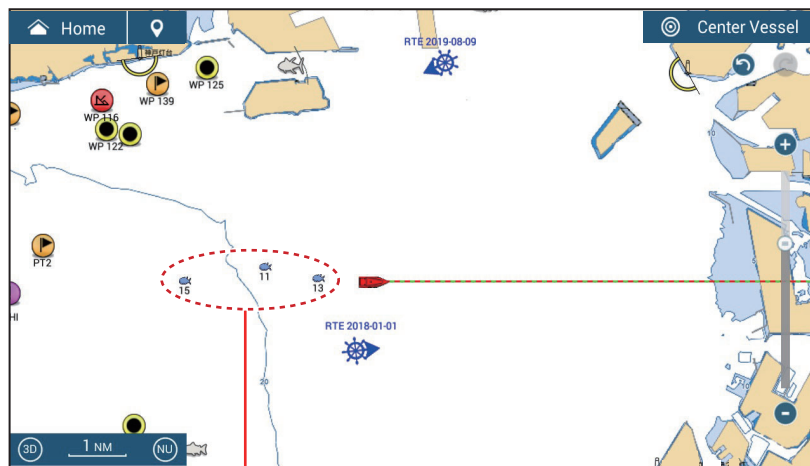

ACCU-FISH icons

4. POINTS, BOUNDARIES

4.1 About Points & Event Marks

In navigation terminology, a point is any location you mark on the chart plotter, radar, sounder or weather display. A point can be a fishing spot, reference point or other important location. You can use a point you have entered to set as a destination.

This unit has 30,000 points (including event marks and MOB marks) into which you can enter position information.

A point is used to mark a location. When you enter a point, it is put on the screen with the default point icon (see section 4.5.1), as shown in the figure below.



The event mark marks current position. Like with a point, you can use an event mark to set a destination.

For the TZT9F/12F, the event mark is entered with the **EVENT/MOB** key, and is marked on the screen with the default event mark icon. See section 4.5.2.

A point or event mark is saved to the [Points] list with position, color, shape, etc. In the default setting, all points and event marks are shown on the display



You can edit points and event marks on the screen and from the [Points] list.

Note 1: Event marks are handled the same as points.

Note 2: Points can be shared with other NavNet TZtouch3 units via LAN. Data is shared automatically; no operation is required.

4.2 How to Enter Points, Event Marks

4.2.1 How to enter a point (chart plotter and radar displays only)

Method 1: Directly on-screen

1. Tap the position on the screen where to put a point.

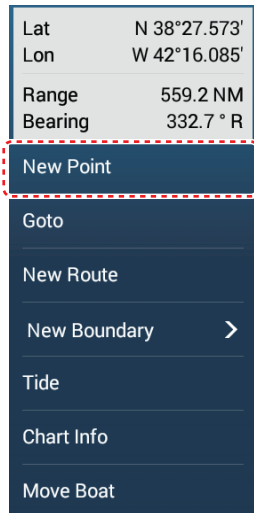

Example pop-up: chart plotter display

2. Tap [New Point] on the pop-up menu.

The default point icon is put at the position selected, and the point is saved to the [Points] list.

Method 2: Manual input (chart plotter, radar, weather)

Open the Slide-out menu, then tap [Position Entry]. The position shown is latitude/longitude of the center of the displayed area. Edit the position as required. Tap [✓] to register the point and close the keyboard.

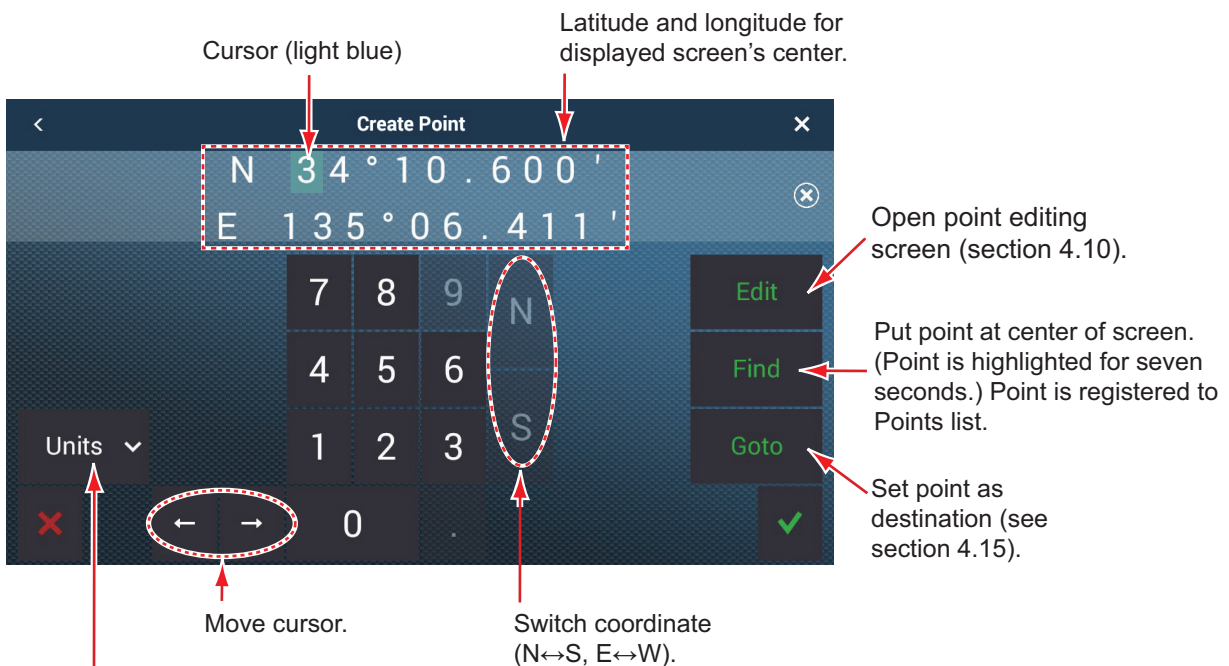

Position display format

Select position display format from pull-down menu.

Method 3: Register point on the Points list

1. Go to the Home screen, then tap [Lists]→[Points] to show the [Points] list.
2. Tap the [Add Point] button at top of the screen. The [Point] screen shows the latitude and longitude of the point to be registered and its location (on the preview screen).
3. Edit the point referring to section 4.10.2.
4. Tap X on the title bar to close the menu.

Method 4: Input from external equipment

External equipment (fish finder, etc.) can output points to this equipment. TLL data (NMEA 0183 format) from the external equipment is output to this equipment via an NMEA data converter (IF-NMEA2K2, option). The latitude and longitude position of the point is marked with the event icon.

4.2.2 How to enter an event mark**Method 1: EVENT/MOB key (TZT9F/12F only)**

Press the **EVENT/MOB** key. The event mark is automatically named as “WPXXX” (XXX=3 digit number, sequential). You can turn off automatic naming (only the icon is shown) of a point. See section 4.12.

Method 2: Event mark

At the top left corner, tap the event icon to show the [Creating Events] window, shown below. Tap desired event mark.

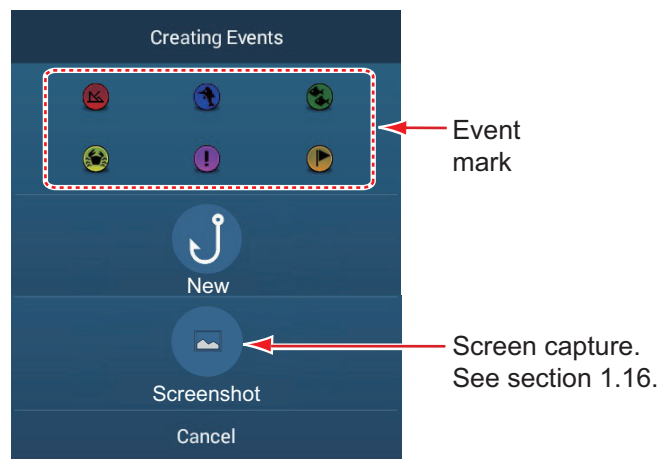
**Method 3: Two-finger tap**

An event mark can be entered by tapping the screen with two fingers. To enable this function, open [Settings]→[General]. Set [Two Finger Tap Function] (or [Two Finger Long Tap Function] for [Event Mark] (see section 1.16). Then, tap (long tap if the function is set up for long tap) the screen with two fingers to show the [Creating Events] window. Tap desired mark.

Method 4: Put event mark on desired location on the fish finder display

You can put an event mark on a desired location on the fish finder display.

Depth	66.4 ft
Range	0.731 NM
New Point	
Fish-It	

1. On the fish finder display, tap the location where to put an event mark.
2. On the pop-up menu, tap [New Point] to show the [Creating Events] window.
3. Tap desired event mark.
The selected mark appears on the fish finder display and the point is added to the [Points] list. The event mark appears on both the fish finder and chart plotter displays, however the point name is not shown on the fish finder display

Method 5: Log Catch

You can log the specifics of a catch (species, size, weight) together with an event mark, from the [Creating Events] window.

1. Open the [Creating Events] window, following method 2 or method 3 in this section, then tap [New].

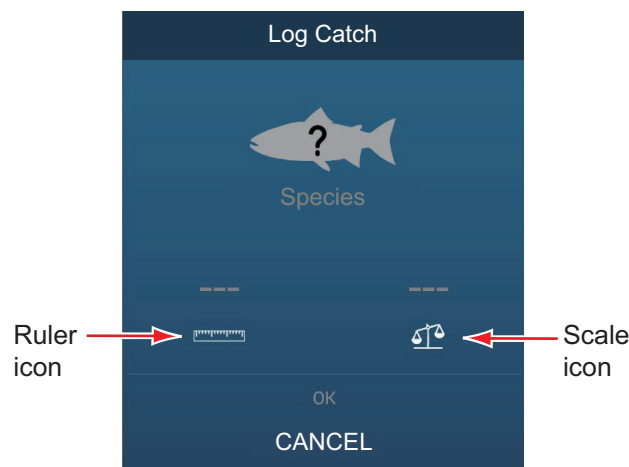

2. Tap [Species] to show the [Species] list. Tap applicable species in the list. A maximum of four species can be shown in the [Creating Events] window. When that amount is exceeded, the eldest species is deleted from the window.
3. Tap the Ruler icon to show the software keyboard. Enter length, then tap ✓ to confirm entry.
4. Tap the Scale icon to show the software keyboard. Enter weight, then tap ✓ to confirm entry.
5. Tap [OK] on the [Creating Events] window.

You can see the number of catches you have logged on the [DATA USAGE] section in the [General] menu. In the example below, two catches have been logged out of 1000.

DATA USAGE	
Points	3 / 30000
Routes	0 / 200
Areas & Lines	0 / 100
Circles	0 / 100
Photos	0 / 1000
Catches	2 / 1000
Track Points	13794 / 30000

4.2.3 How to enter an event mark at a specific location

You can enter an event mark at a specific location on the fish finder display.

1. Tap the location on the fish finder display where to enter an event mark. The pop-up menu appears.

Depth	2,617 ft
Range	7.179 NM
New Point	
Fish-It	

2. Tap [New Point] on the pop-up menu. The [Creating Events] window appears. See section 4.2.2.
3. Select an event mark. The event mark is put at the location selected at step 1 and the point is saved to the [Points] list. The event mark appears on both the fish finder and chart plotter displays. However, the name of the event mark does not appear on the fish finder display.

4.3 How to Display Point, Event Mark, Catch Information

Tap a point, event mark, or catch mark to display its basic information (latitude, longitude, range from own ship, bearing from own ship, depth (event mark only).



4.4 How to Enter a Comment for an Event Mark

You can automatically attach a comment to an event mark. The comment is saved to the [Points] list, and the default comment is [None] (no comment). To apply a comment, do as follows:

1. Go to the Home screen, then tap [Settings]→[Points & Boundaries]→[Data to Be Recorded in Event Comment].
2. Tap an option.
 - [None]: No comment
 - [Date]: Date
 - [SST]: Sea surface temperature
 - [Date and SST]: Date and sea surface temperature
3. Tap the close button on the title bar to finish.

4.5 Default Point, Event Mark Settings

4.5.1 Default point settings

The equipment saves a point in the shape, color and size assigned on the [Points & Boundaries] menu. If the default point settings are not to your liking, change them as shown in the procedure below.

1. Go to the Home screen, then tap [Settings]→[Points & Boundaries].

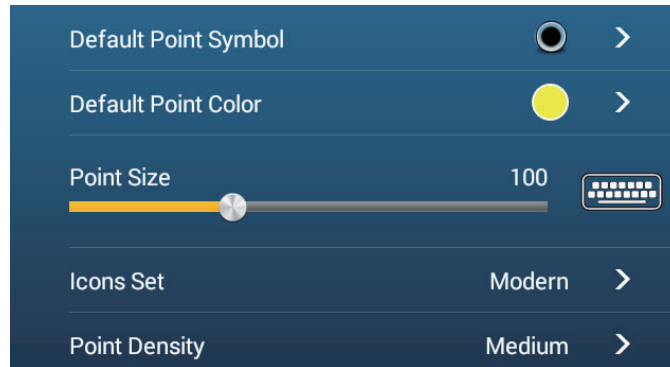

2. Tap [Default Point Symbol].

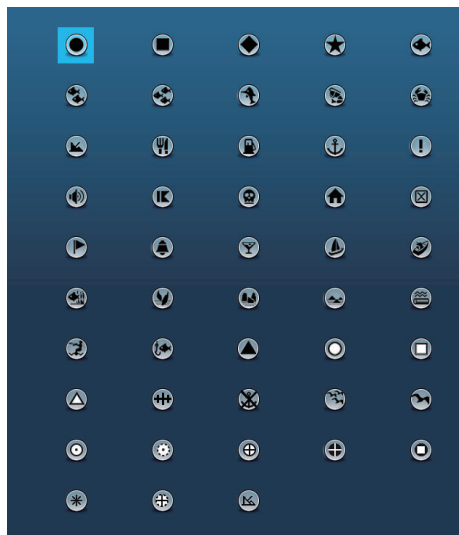

3. Tap required symbol, then tap [<] to return one layer in the menu.
4. Tap [Default Point Color] to show the color options for points.

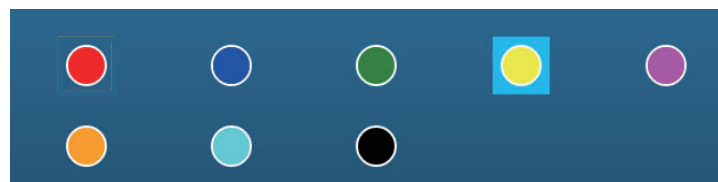

5. Tap required color, then tap [<] to return one layer in the menu.
6. To change point size. operate the slider bar or software keyboard at [Point Size]



4. POINTS, BOUNDARIES

7. Tap [Icons Set] to select the icons set to use.

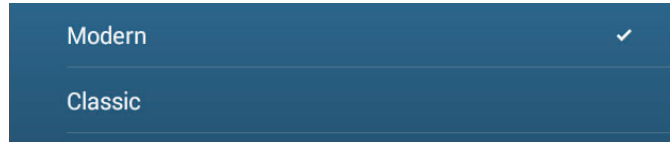

8. Select [Modern] or [Classic], referring to the figure below.



9. Tap the close button on the title bar to finish.

4.5.2 Default event mark settings

1. Go to the Home screen, then tap [Settings]→[Points & Boundaries].
2. Tap [Default Event Mark 1 Symbol].

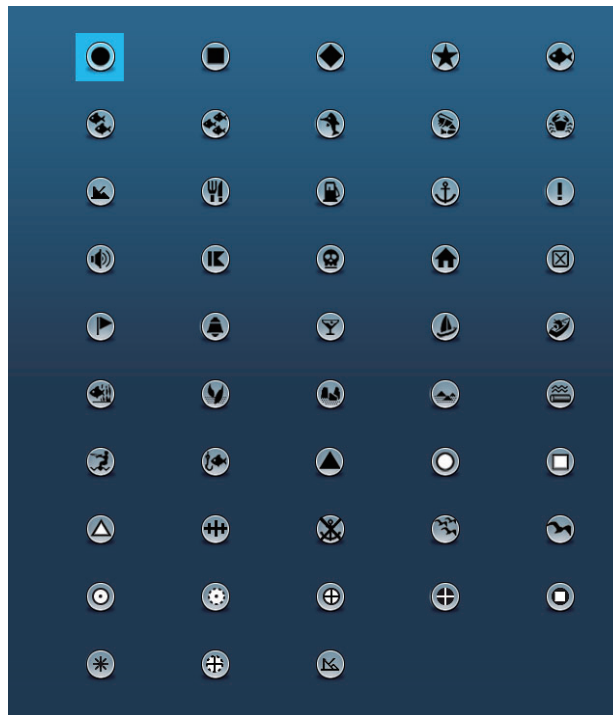

3. Tap required symbol, then tap [<] to return one layer in the menu.
4. Tap [Default Event Mark 1 Color] to show the color options for points.

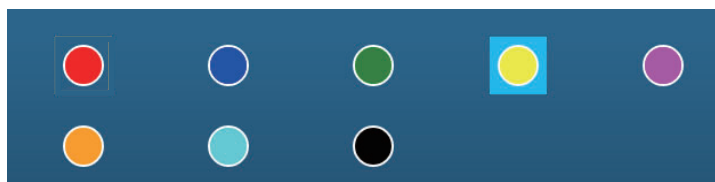

5. Tap required color, then tap [<] to return one layer in the menu.
6. Process Event Mark 2 - 6 similar to how you processed Event Mark 1.
7. Tap the close button to close the menu

Note: If you do not require event marks 2 - 6, turn on [Record Event1 Automatically] in the [Points & Boundaries] menu. In this case, the pop-up menu does not appear when you register an event mark. See section 4.2.2.

4.6 How to Find Number of Points Used

Go to the Home screen, then tap [Settings]→[General]. Find [Points] in the [DATA USAGE] section. In the example below, 3 of 30,000 points have been used.

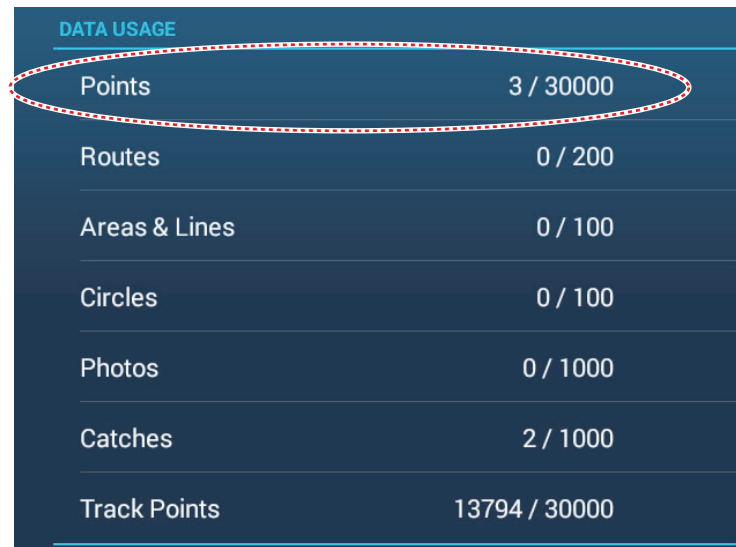

DATA USAGE	
Points	3 / 30000
Routes	0 / 200
Areas & Lines	0 / 100
Circles	0 / 100
Photos	0 / 1000
Catches	2 / 1000
Track Points	13794 / 30000

4.7 Points List

All points are stored in the [Points] list. The following point data is saved for each point.

- Name
- Position (latitude/longitude)
- Color
- Icon
- Comment
- Distance from own ship

4.7.1 How to show the Points list, process points

1. Go to the Home screen, then tap [Lists]→[Points] to open the [Points] list.

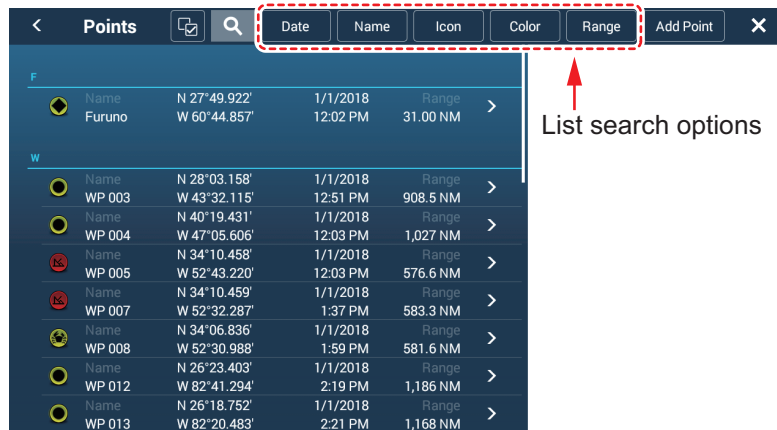

2. Tap the appropriate sort button at the top of the list.

How to sort points

The [Points] list can be sorted by the following methods:

[Date] Sort by date registered, in oldest-to-newest order.

[Name]: Sort by point name, in alphabet order.

[Icon]: Sort by icon shape.

[Color]: Sort by color.

[Range]: Sort by range from own ship, from nearest to farthest.

How to search points

- 1) Tap the magnifying glass icon on the [Points] list to show the software keyboard.

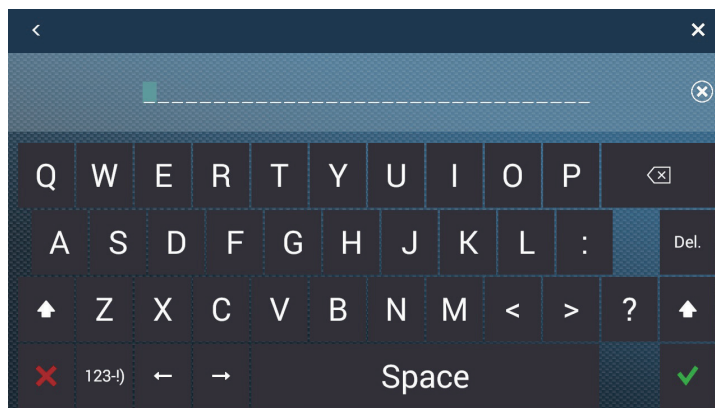

- 2) Enter a search string (full name, 2 - 3 characters), then tap [✓]. The [Points] list shows the matches found.

Search by alphabet

- 1) Tap [Name] if it is not already selected.
- 2) Tap appropriate alphabet on the list.



A search keyboard appears, with the alphabet search-able alphabet(s) colored blue.

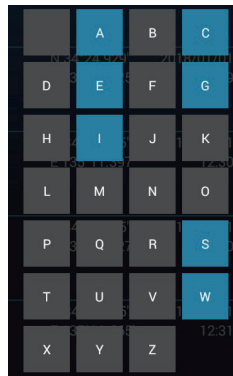

- 3) Tap the alphabet to search.

Search by icon or color:

- 1) Tap the [Icon] (or [Color]) button if it is not already selected.
- 2) Tap icon (or color).



Search by icon



Search by color

4. POINTS, BOUNDARIES

Respective search display appears.

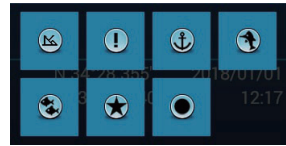

Search by icon

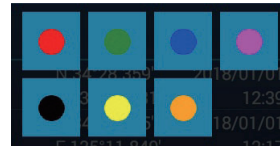

Search by color

- 3) Tap the icon (or color) to search.
The [Points] list shows the tapped icon (or color).
3. Tap the point to confirm or edit to show the Edit screen.

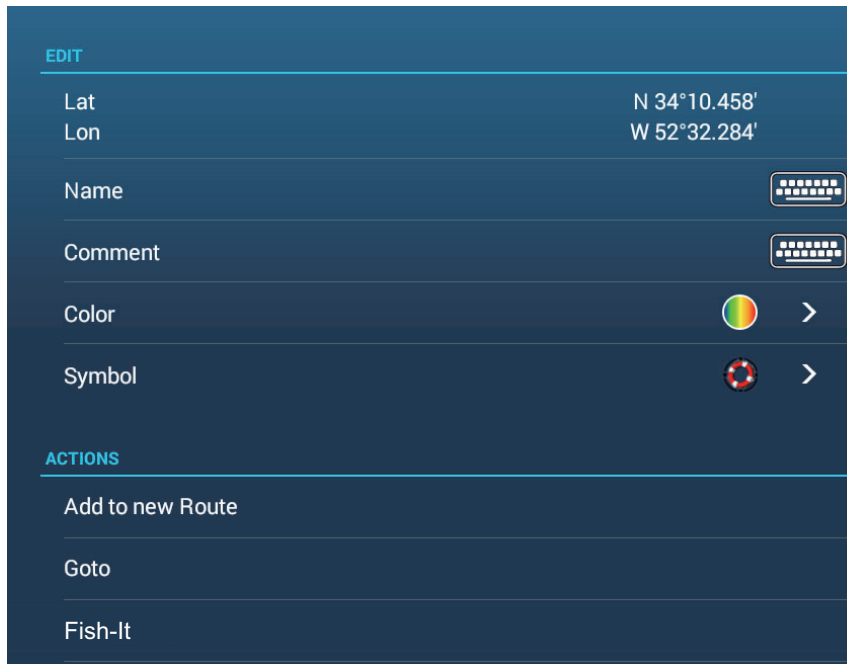

EDIT

Lat N 34°10.458'
Lon W 52°32.284'

Name [text input]

Comment [text input]

Color [color picker]

Symbol [symbol picker]

ACTIONS

Add to new Route

Goto

Fish-It

4. Tap the item (name, comment, color, icon) to edit. See section 4.10 for how to edit points.
5. Tap the close button on the title bar to finish.

Catches list

Like with points, catch log symbols are stored in a list. On the Home screen, tap [Lists]→[Catches] to show the [Catches] list. For how to sort*, search, edit and delete catch log data, see the applicable procedure in the points section.

* The order of the date sort is newest date created.

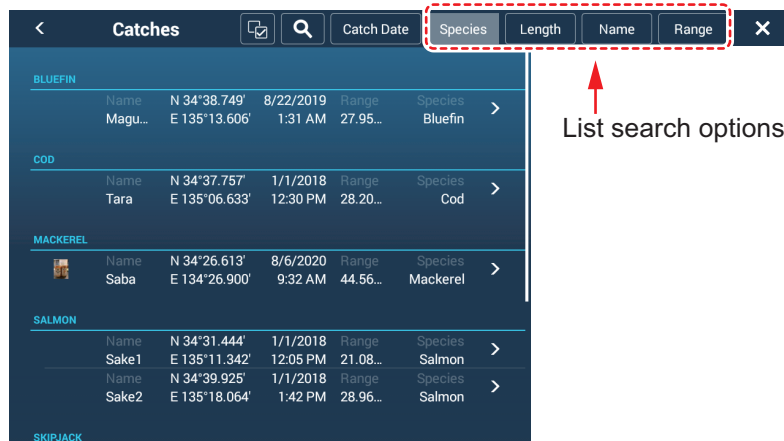

Catches [copy] [search] [Catch Date] [Species] [Length] [Name] [Range] [close]

Species	Name	Catch Date	Range	Species
BLUEFIN				
	Name N 34°38.749'	8/22/2019	Range	Species
	Magu... E 135°13.606'	1:31 AM	27.95...	Bluefin
COD				
	Name N 34°37.757'	1/1/2018	Range	Species
	Tara E 135°06.633'	12:30 PM	28.20...	Cod
MACKEREL				
	Name N 34°26.613'	8/6/2020	Range	Species
	Saba E 134°26.900'	9:32 AM	44.56...	Mackerel
SALMON				
	Name N 34°31.444'	1/1/2018	Range	Species
	Take1 E 135°11.342'	12:05 PM	21.08...	Salmon
	Name N 34°39.925'	1/1/2018	Range	Species
	Take2 E 135°18.064'	1:42 PM	28.96...	Salmon
SKIPJACK				

List search options

4.8 How to Move Points

You can move a point by two methods, on the screen and from the [Points] list.

4.8.1 How to move an on-screen point

1. Tap the point to move, then select [Move] from the pop-up menu. The icon shown right is put on the point.
2. Drag and drop the point to its new location.
3. Tap [End Move] at the top right-hand corner of the screen to finish.



Note: A point can be moved to the position you specify. Tap the point and [Edit], then enter the latitude and longitude position from the software keyboard.

4.8.2 How to move a point using the pop-up window

1. Tap the point to move to show the pop-up window. See section 4.3.
2. Tap the latitude and longitude information at the top of the window to show the software keyboard.
3. Change the latitude and longitude as necessary, then tap [✓]. The point is then centered on the screen.

4.8.3 How to move a point using the Points list

1. Go to the Home screen, then tap [Lists]→[Points] to open the [Points] list.
2. Tap the point to move to show the editing window.
You can also edit the position of a point from the screen. Tap the point then tap [Edit] on the pop-up menu.
3. Tap [Lat Lon] to display the numeric keyboard.
4. Enter the position then tap [✓] to confirm.
5. Tap the close button on the title bar to finish.

4.9 How to Delete Points

You can delete points by two methods, on the screen and from the [Points] list

Note: The point currently set as a Goto point cannot be deleted.

4.9.1 How to delete an on-screen point

Tap the point to delete, then tap [Delete] on the pop-up menu.

4.9.2 How to delete a point via the Points list

1. Go to the Home screen, then tap [Lists].
2. Tap [Points] to open the [Points] list.
3. Tap the point to delete, then tap [Delete]. The point disappears from both the screen and the [Points] list.
4. Tap the close button on the title bar to finish.

4.9.3 How to delete points collectively via the Points list

The  icon in the title bar on the [Points] list allows you to edit and delete points collectively.

1. On the Home screen, tap [Lists]→[Points] to show the [Points] list.
2. At the top of the [Points] list, choose how to sort the points.
3. Tap the  icon. In the example list below the points are sorted by name.



Points				
<input type="checkbox"/>	F	Name	N 33°04.155'	1/1/2018
<input type="checkbox"/>		FISH1	E 134°31.005'	12:53 PM
				74.34 NM
<input type="checkbox"/>		Name	N 33°35.538'	1/1/2018
<input type="checkbox"/>		FISH2	E 134°37.356'	12:55 PM
				44.85 NM
<input type="checkbox"/>		Name	N 34°33.548'	1/1/2018
<input type="checkbox"/>		FISH3	E 135°16.073'	1:00 PM
				23.03 NM
<input type="checkbox"/>		Name	N 34°26.622'	1/1/2018
<input type="checkbox"/>		FISH4	E 135°06.157'	12:55 PM
				16.12 NM
<input type="checkbox"/>	G	Name	N 34°36.938'	1/1/2018
<input type="checkbox"/>		GOTO1	E 134°46.522'	12:17 PM
				32.75 NM
<input type="checkbox"/>		Name	N 34°38.569'	1/1/2018
<input type="checkbox"/>		GOTO2	E 134°42.627'	1:05 PM
				36.03 NM
<input type="checkbox"/>	P	Name	N 34°29.200'	1/1/2018
<input type="checkbox"/>		POINT1	E 134°41.188'	12:40 PM
				30.45 NM
<input type="checkbox"/>		Name	N 34°00.572'	1/1/2018

4. Put a checkmark (✓) in the checkbox of the point to delete, or check a sort title to delete all points within that title. For example, in the [Points] list above, check “F” to delete all photos whose name begins with “F”.
5. On the title bar, tap [Delete Checked Items]. A message asks if you are sure to delete checked points. Tap [OK] to delete the points.

Like with points you can delete log catches from the [Catches] list.

4.9.4 How to delete all points via the menu

You can delete all points and routes except for the points included in the active route.

1. Go to the Home screen, then tap [Settings]→[Points & Boundaries]→[Delete All User Objects]. The message "Are you sure you want to delete all your user objects (marks, routes, boundaries, ...) from this device and all other networked devices? If the cloud synchronization is enabled, this will also remove all user objects from any devices connected with the same TIMEZERO account. This action cannot be undone." appears.
2. Tap [OK].
Note: The “Cancel” icon does not appear when deleting all points.
3. Tap the close button on the title bar to finish.

4.10 How to Edit Points

Registered points can be edited on-screen and from the [Points] list.

4.10.1 How to edit an on-screen point

1. Tap the point to edit, then tap [Edit] on the pop-up window.



2. **To change position**, tap [Lat Lon] to show the software keyboard.



Units: Open the pull-down menu to change the position display format.

- 1) Tap numeric keys to enter position; tap the alphabet (N, S, E, W) to switch coordinates.
 - 2) Use the software keyboard to edit the position.
 - 3) Repeat steps 1) - 2) to change the position.
 - 4) Tap [✓] to finish.
3. **To change point name**, tap [Name] to show the software keyboard. See section 1.15.
 - 1) On the point name field, tap the alphanumeric character to change.
 - 2) Use the software keyboard to enter alphanumeric character.
 - 3) Repeat steps 1) - 2) to change other characters in the name.
 - 4) Tap [✓] to finish.

4. POINTS, BOUNDARIES

4. **To change point comment**, tap [Comment] to show the software keyboard. After changing the comment, tap [✓] to finish.
5. **To change point color**, tap [Color]. Tap desired color, then tap [<] on the title bar to go back one layer in the menu.
6. **To change point icon**, tap [Symbol]. Tap desired symbol, then tap [<] on the title bar to go back one layer in the menu.
7. Tap the close button on the title bar to finish.

4.10.2 How to edit a point via the Points list

1. Go to the Home screen, then tap [Lists]→[Points] to show the [Points] list.
2. Tap the point to edit.
3. Do steps 2 - 6 in section 4.10.1 to edit the point.
4. Tap the close button on the title bar to finish.

4.10.3 How to edit points collectively via the Points list

The  icon in the title bar on the [Points] list allows you to edit points collectively.

1. On the Home screen, tap [Lists]→[Points] to show the [Points] list.
2. At the top of the [Points] list, choose how to sort the points.
3. Tap the  icon. In the example list below the points are sorted by name.



Points						Delete Checked Items	Edit Checked Items	×
<input type="checkbox"/>	F	Name	N 33°04.155'	1/1/2018	Range			
<input type="checkbox"/>		FISH1	E 134°31.005'	12:53 PM	74.34 NM			
<input type="checkbox"/>		Name	N 33°35.538'	1/1/2018	Range			
<input type="checkbox"/>		FISH2	E 134°37.356'	12:55 PM	44.85 NM			
<input type="checkbox"/>		Name	N 34°33.548'	1/1/2018	Range			
<input type="checkbox"/>		FISH3	E 135°16.073'	1:00 PM	23.03 NM			
<input type="checkbox"/>		Name	N 34°26.622'	1/1/2018	Range			
<input type="checkbox"/>		FISH4	E 135°06.157'	12:55 PM	16.12 NM			
<input type="checkbox"/>	G	Name	N 34°36.938'	1/1/2018	Range			
<input type="checkbox"/>		GOTO1	E 134°46.522'	12:17 PM	32.75 NM			
<input type="checkbox"/>		Name	N 34°38.569'	1/1/2018	Range			
<input type="checkbox"/>		GOTO2	E 134°42.627'	1:05 PM	36.03 NM			
<input type="checkbox"/>	P	Name	N 34°29.200'	1/1/2018	Range			
<input type="checkbox"/>		POINT1	E 134°41.188'	12:40 PM	30.45 NM			
<input type="checkbox"/>		Name	N 34°00.572'	1/1/2018	Range			

4. Put a checkmark (✓) in the checkbox of the point to edit, or check a sort title to edit all points within that title. For example, in the [Points] list above, check “F” to edit all points whose name begins with “F”.

5. On the title bar, tap [Edit Checked Items].

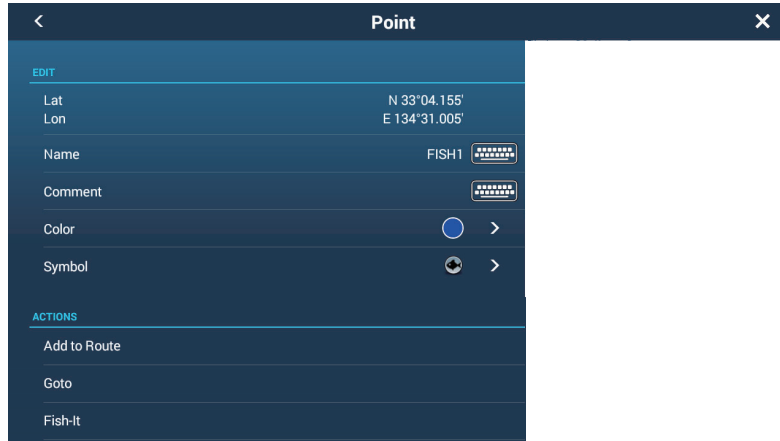

6. To edit the name, comment, color, or icon, tap the item to edit and refer to the procedure in section 4.10.1.
 7. Tap [Save & Close] to save changes and close the list.
- Like with points you can edit log catches from the [Catches] list.

4.11 How to Move a Point to the Screen Center

You can easily place a point at the center of the chart plotter display from the [Points] list.

1. Go to the Home screen, then tap [Lists].
2. Tap [Points] to open the [Points] list.
3. Tap [Name], [Icon], [Color] or [Range] at the top of the list to sort the list.
4. Tap the point to find then tap [Find On Chart].

The menu closes, the selected point is put at the center of the screen on the chart plotter display, and is highlighted for seven seconds.

Note: If a split screen is in use when this procedure is initiated, the split screen is replaced with the full screen chart plotter display, then the point is put at the center of the full screen display.

4.12 How to Show or Hide All Points, Points Names

Points

Open the Layers menu, then turn [Points] on or off.

Points names

Go to the Home screen, then tap [Settings]→[Points & Boundaries]. Turn [Display Points Names] on or off.

4.13 How to Set Point Naming Functions

In the default setup, a point or event mark is automatically assigned the name “WPXXX” (XXX=three-digit number, sequential order, starting with 001). If you do not need automatic numbering or you want to change the prefix “WP” to something else, follow the procedure below.

1. Go to the Home screen, then tap [Settings]→[Points & Boundaries].
2. Turn [Automatic Naming] ON (automatic naming enabled) or OFF (automatic naming disabled) is required.
3. To change the name prefix, tap [Automatic Naming Prefix] to show the software keyboard.
4. Enter desired name prefix, then tap [✓]
5. ×Tap the close button on the title bar to finish.

4.14 How to Set Point Density

The screen can become cluttered if all points are shown. To prevent this, set point density as shown below to limit the number of points to show.

1. On the Home screen, tap [Settings]→[Points & Boundaries]→[Point Density] to show the following options menu.

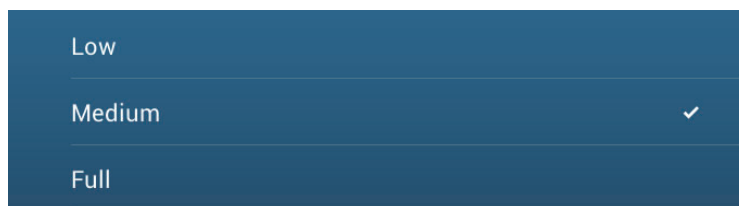

2. Tap desired point density. [Low] is the lowest point density, and [Full] displays all points.
3. Tap X on the title bar to close the menu.

4.15 How to Go to a Point

Tap the point (including MOB mark) to go to among the three methods shown below.

- Select the point on the screen
- Select a position on the screen
- Select the point from the [Points] list

After you have selected a point, you can do the following.

- Restart the cross-track error (XTE) indication.
- Stop and restart Goto. (Tap the own ship icon to display the pop-up menu. Tap [Stop Nav] and [Restart Nav] respectively.)
- Set how the autopilot behaves when you reach your destination (requires connection to a NAVpilot series autopilot).

Note: Before you try to go to a point, make sure that the path to the point is clear. Make sure to zoom your chart to check for hazards which appear on a smaller scale.

4.15.1 How to go to an on-screen point

1. Tap the desired point to show the pop-up menu.
2. Tap [Goto].

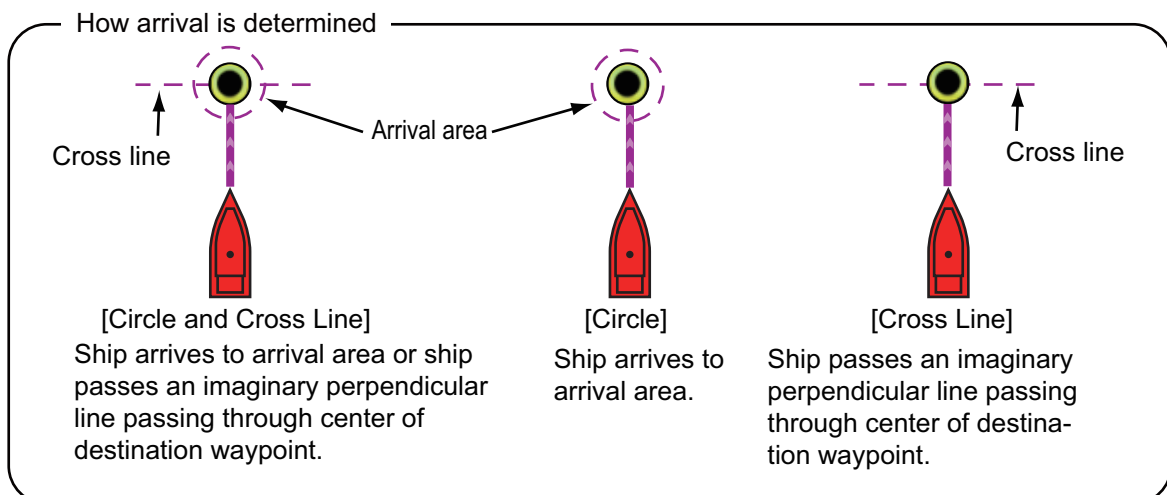
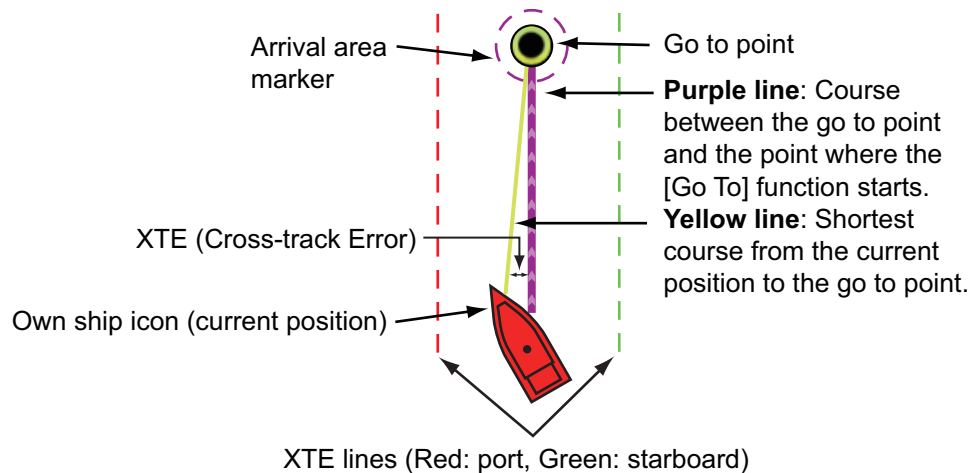

4. POINTS, BOUNDARIES

The following occurs:

- The Goto point is highlighted.
- A purple line and a yellow line extend from the own ship icon. The purple line is the course to follow to get to the point. The yellow line is the shortest course from the current position to the Goto point.
- The navigation bar (provides destination information) appears at the top of the display.

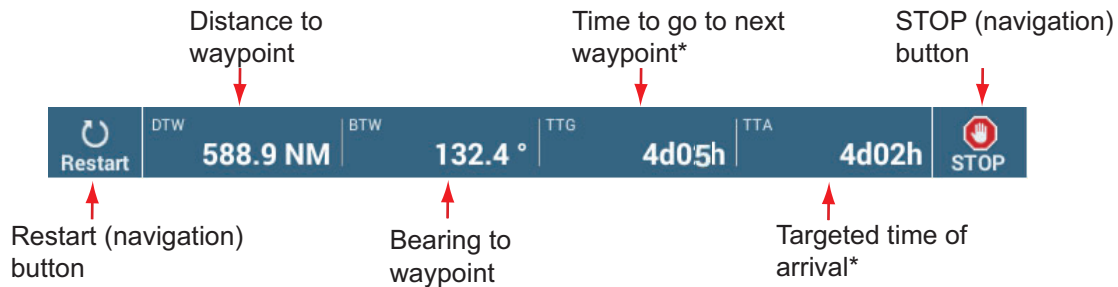

* These figures are the same when navigating to a point.

For how to use the [Restart] and [STOP] buttons, see section 4.16.

- The waypoint switching method is determined according to the respective setting on the menu. Select the format by [Settings]→[Routes]→[WPT Switch Mode]. Select [Circle and Cross Line], [Circle] or [Cross Line].
- The XTE lines, red for port side, green for starboard side, appear. You can show or hide these lines with [Cross Track Error Lines] in the [Settings]→[Routes] menu.

Note: If you want to be notified when you reach the Goto point (the end of a route), turn on [End of Route Notification] in the [Routes] menu (see subsection 5.11.9). The message "End of Route" appears when you reach the end of a route. For the arrival timing, see subsection 5.11.5.

4.15.2 How to go to a position selected on screen

You can set a position as a point to go to without saving the point. The point is erased when the navigation is canceled or the power is turned off.

1. Tap the position to set as the Goto point to show the pop-up menu.
2. Tap [Goto].

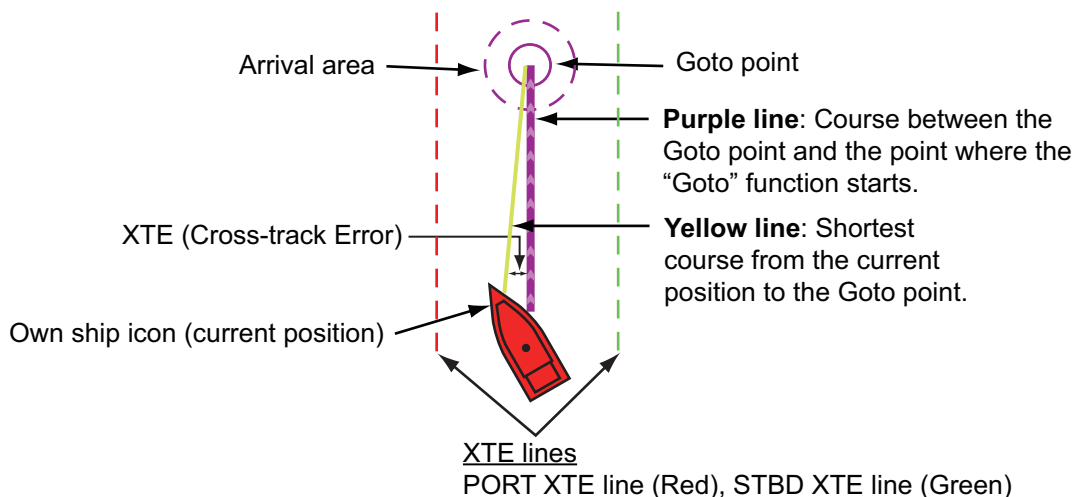

The following occurs:

- The Goto point is highlighted.
- A purple line and a yellow line appear on the own ship icon. The purple line is the course to follow to get to the point. The yellow line is the shortest course from the current position to the Goto point.
- The navigation bar (provides destination information) appears at the top of the display.

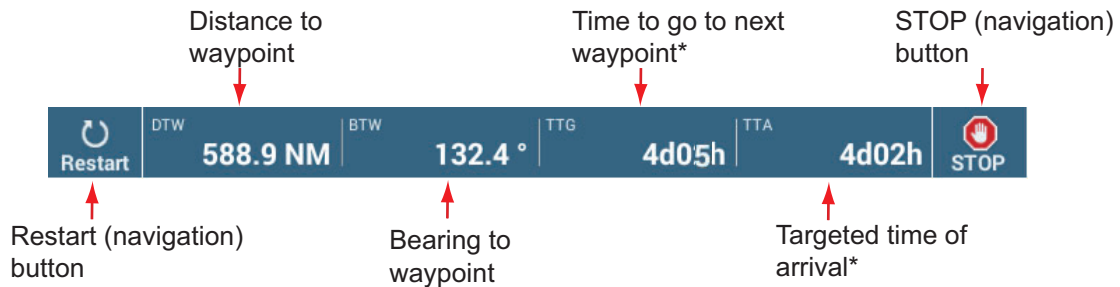

* These figures are the same when navigating to a point.

For how to use the [Restart] and [STOP] buttons, see section 4.16.

- The waypoint switching method is determined according to the respective setting on the menu. Select the format by [Settings]→[Routes]→[WPT Switch Mode]. Select [Circle and Cross Line], [Circle] or [Cross Line].
- The XTE lines, red for port side, green for starboard side, appear. You can show or hide these lines with [Cross Track Error Lines] in the [Settings]→[Routes] menu.

Note: If you want to be notified when you reach the Goto point (the end of a route), turn on [End of Route Notification] in the [Routes] menu (see subsection 5.11.9). Then the message "End of Route" appears when you reach the end of a route. For the arrival timing, see subsection 5.11.5.

4.15.3 How to go to a point selected from the Points list

1. Go to the Home screen, then tap [Lists]→[Points] to open the [Points] list.
2. If you need to sort the list, use one of the sort buttons at the top of the list.
3. Tap the point to use.
4. Tap [Goto].

The following occurs:

- The Goto point is highlighted in the [Points] list.
- A purple line and a yellow line appear on the point. The purple line is the course to follow to get to the point. The yellow line is the shortest course from the current position to the Goto point.
- The navigation bar (provides destination information) appears at the top of the display.

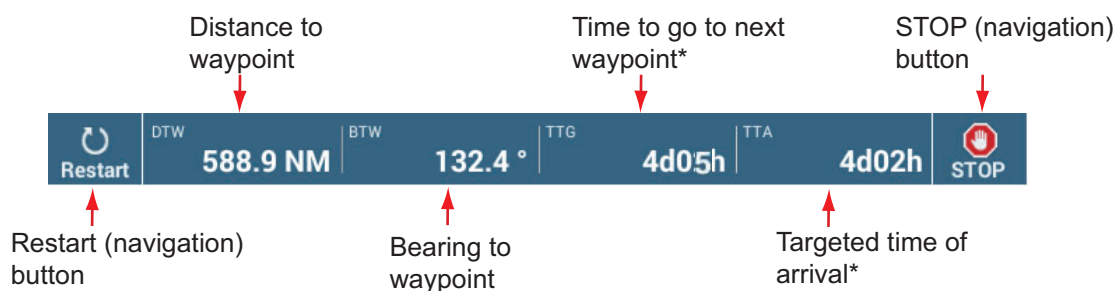

* These figures are the same when navigating to a point.

For how to use the [Restart] and [STOP] buttons, see section 4.16.

- The waypoint switching method is determined according to the respective setting on the menu. Select the format by [Settings]→[Routes]→[WPT Switch Mode]. Select [Circle and Cross Line], [Circle] or [Cross Line].
- The XTE lines, red for port side, green for starboard side, appear. You can show or hide these lines with [Cross Track Error Lines] in the [Settings]→[Routes] menu.

Note: If you want to be notified when you reach the Goto point (the end of a route), turn on [End of Route Notification] in the [Routes] menu (see subsection 5.11.9). Then the message "End of Route" appears when you reach the end of a route. For the arrival timing, see subsection 5.11.5.

4.15.4 How to use the NAVpilot to steer to a point

When you select a point to follow and a FURUNO NAVpilot is engaged and activated in the system, the message "DO YOU WANT TO NAVIGATE USING THE NAVPILOT?" appears. Tap [Yes] to have the NAVpilot steer the vessel, then the NAVpilot automatically goes into the NAV mode.

For the NAVpilot-300, you are asked to select a navigation mode. Select [Precision] or [Economy]. ([Cancel] stops the NAV mode.) After selecting a mode, the NAVpilot-300 automatically goes into the NAV mode.

Precision mode: Keeps XTE within 0.01 NM

Economy mode: Keeps XTE within 0.03 NM

Note: The example figure below shows the NAVpilot's display in the NAV mode. See section 2.13.3 for details.

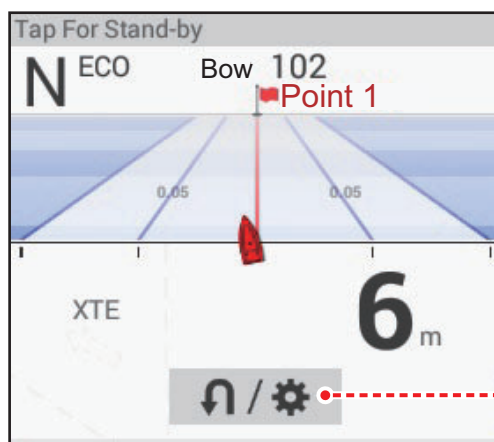

Turn/Setting

Appears when NAVpilot-300 is engaged.

4.15.5 How to display the point information for the active goto point

1. Tap the yellow line that runs between own ship and the Goto point to show the pop-up menu. Note that the purple line can also be tapped to show the pop-up menu.
2. Tap [Detail] to show the [Route Detail] window.

Stop Nav

Restart

Detail

Route Detail								×
ID	BTW	SPEED	DISTANCE	TOTAL	TTG	TOTAL		>
Start	—°	10.0 kn	0 ft	0 ft	0'00s	0'00s		>
ID	BTW	SPEED	DISTANCE	TOTAL	TTG	TOTAL		>
Goto	109.5°	10.0 kn	346.0 NM	346.0 NM	2d10h	2d10h		>

3. Tap the close button on the title bar to finish.

Description of Route Detail window

Colored vertical bars: The bars at the left edge of the screen are colored according to the status of the Goto point.

Gray: Starting point

Yellow: Goto point

4. POINTS, BOUNDARIES

[ID]: Point no. ([Start] or [Goto])

[BTW]: Bearing to Goto point

[SPEED]: Speed to Goto point

[DISTANCE]: Distance from starting point

[TOTAL]: Total distance from start to Goto point

[TTG]: Time to go to the Goto point, using speed shown in [SPEED] column.*

[TOTAL]: The time from start to the Goto point.*

* Calculated by the value in the [SPEED] column.

4.16 How to Restart or Cancel Navigation to a Point

4.16.1 How to restart navigation to a point

When you go to a point, you can restart the navigation to the point from the current location.

When you steer to keep away from an obstruction or the ship drifts, you go off course as shown in Line 1 in the figure. If you do not need to return to the original course, you can go to the point from the current position as shown in Line 2 in the figure.

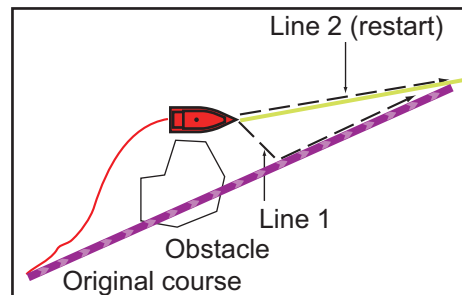

You can restart navigation by two methods:

From navigation bar

Tap the [Restart] button in navigation bar.

From the pop-up menu

1. Tap the purple line or the yellow line of the route to display the pop-up menu.
2. Tap [Restart]. The route start position for the route moves to the current position.

4.16.2 How to cancel navigation to a point

From navigation bar

Tap the [STOP] button in navigation bar.

From the pop-up menu

1. Tap the purple line or the yellow line of the route to display the pop-up menu.
2. Tap [Stop Nav]. The route start position for the route moves to the current position.

The set course, yellow line, XTE lines, arrival area, and the navigation bar are erased from the screen.

From the Slide-out menu

Open the Slide-out menu, then tap [Stop Nav].

4.17 Boundaries

Boundaries can be marked anywhere on the chart plotter screen, and can be used to denote net position, avoidance areas, etc. Boundaries can be shown or hidden and edited. Additionally, an audiovisual alarm can be set to alert when your vessel approaches a boundary.

Boundaries created with TIMEZERO Marine Software can be imported.

4.17.1 How to create a boundary

A boundary is available in three forms: area, circle, line. A boundary can be stored in the unit's database and shared on a "cloud" (internet connection required) and the local network.

Method 1: How to create a boundary on the screen

1. Tap the location where you want to place a boundary.
2. Tap [New Boundary] on the pop-up window.
3. Tap [Area], [Circle] or [Line] as appropriate. An icon corresponding to the boundary type selected appears at the location selected at step 1.
4. Do one of the following depending on the boundary type selected.

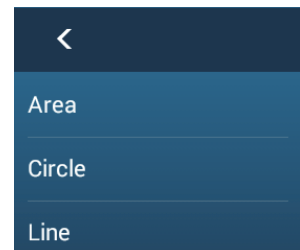

Area boundary

- 1) Tap the location for the next point of the area. A yellow line runs between the 1st location and the 2nd.
- 2) Tap the location for the next point of the area. Repeat this step to complete the area. You can drag an icon to change the position of a point.

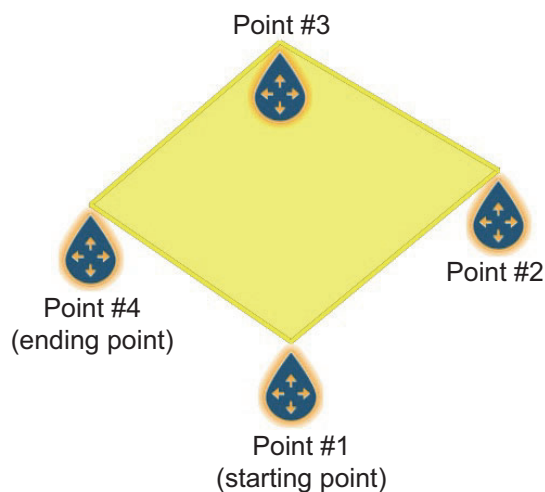

- 3) After selecting the ending point, tap [End Boundary] at the top-right corner.

4. POINTS, BOUNDARIES

Circle boundary

- 1) Tap the location for the circle area. A yellow circle appears with circle resizing icons. Drag the icons to change the location and radius of the circle.

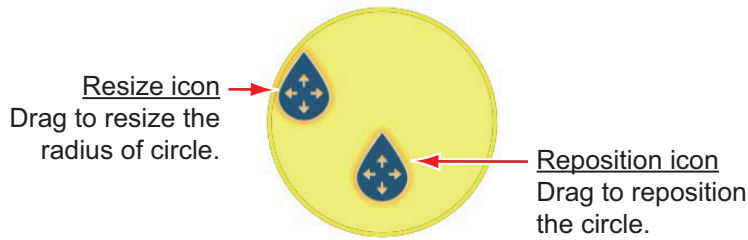

- 2) After arranging the circle, tap [End Boundary] at the top-right corner.

Line boundary

- 1) Tap the location for the next point of the area. A yellow line runs between the 1st location and the 2nd.
- 2) Tap the location for the next point of the area. Repeat this step to complete the area. You can drag an icon to change the position of a point.

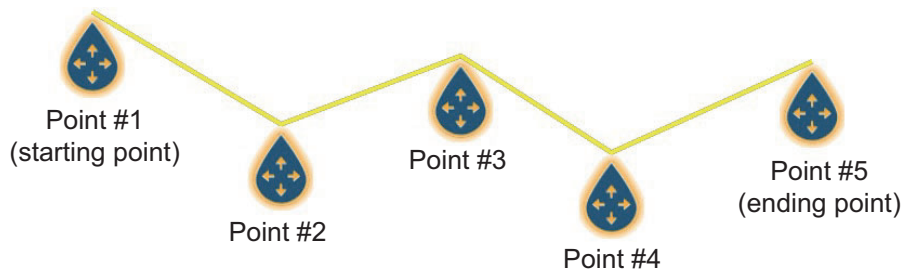

- 3) After selecting the ending point, tap [End Boundary] at the top-right corner. The boundary line is placed at the center of the screen.

Method 2: How to create a boundary via the Boundaries list

1. On the Home screen, tap [Lists]→[Boundaries] to show the [Boundaries] list.
2. At the top of the screen, tap [Add Area] or [Add Line] depending on the type of boundary you want to make.
3. Use the software keyboard to enter the latitude and longitude position of the starting point, then tap [✓].
The point entered at center of the preview screen.
4. Tap [Add Point].
5. Enter the latitude and longitude position of the next point, then tap [✓].
Repeat this step to complete the boundary.
6. Tap [<] on the title bar to go back one layer in the menu.
7. Refer to section 4.17.5 to edit the boundary.
8. Tap the close button on the title bar to finish.

4.17.2 How to show or hide all boundaries

On the Layers menu, turn [Boundaries] [ON] or [OFF].

4.17.3 How to set default boundary attributes

You can set the color, line type and transparency of boundaries on the [Points & Boundaries] menu.

1. On the Home screen, tap [Settings]→[Points & Boundaries]. Scroll to find the [BOUNDARIES] section.

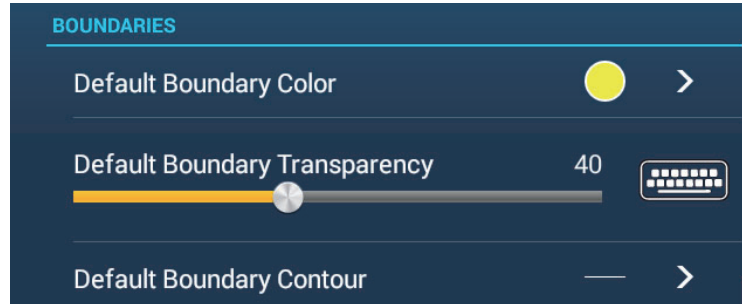

2. Tap [Default Boundary Color].

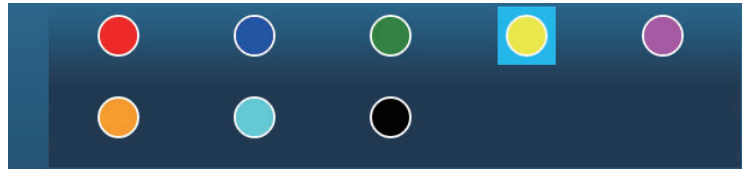

3. Tap the color desired, then tap [<] on the title bar to go back one layer in the menu.
4. To change boundary transparency, adjust the slider bar at [Default Boundary Transparency].
5. Tap [Default Boundary Contour].

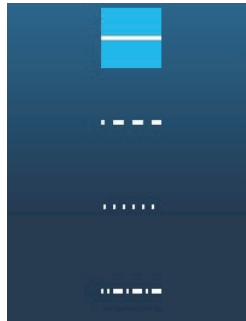

6. Tap the line type desired.
7. Tap the close button at the top of the screen to finish.

4.17.4 Boundaries list

Boundaries are stored on the [Boundaries] list. From the list you can find information about boundaries and edit boundaries. The following data is stored for each boundary created.

- Boundary name
- Boundary comment
- Boundary color
- Boundary line type
- Boundary transparency
- Alarm status
- Distance from own ship
- Boundary latitude and longitude position (circle only)
- Boundary area (circle only)

How to display the Boundaries list

1. On the home screen, tap [Lists]→[Boundaries] to show the [Boundaries] list.

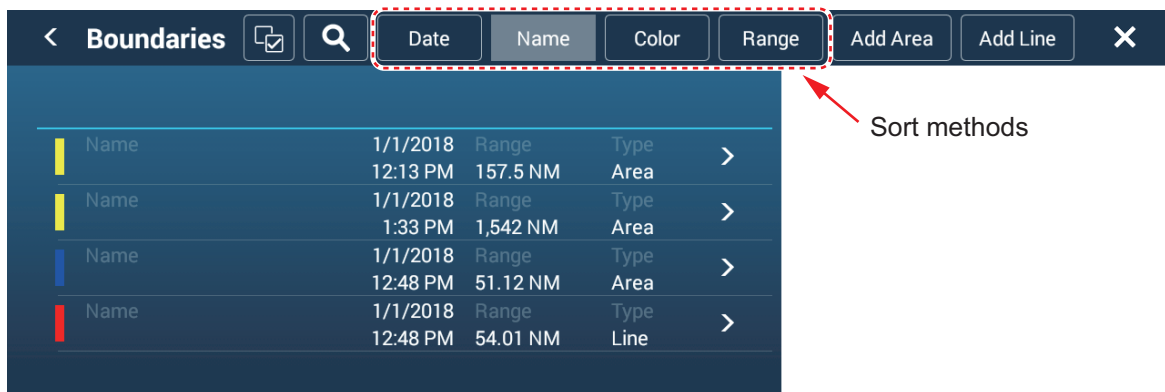

2. To sort the list, do as shown below.

List sorting methods

[Date]: Sort by date

[Name]: Sort by name

[Color]: Sort by color

[Range]: Sort by range from own ship

How to search boundaries

Boundaries can be searched by entering name, alphabet and color.

Search by name

- 1) Tap the magnifying glass at the top of the screen.

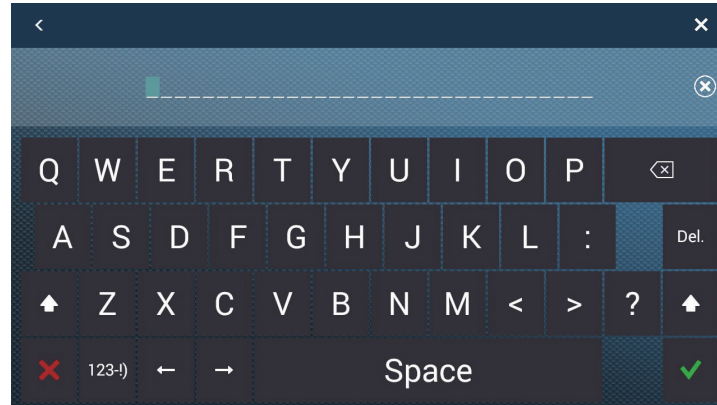

- 2) Enter the name (2-3 characters) of the boundary to search for, then tap [✓]. Boundaries matching the name entered appear in the list.

Search by alphabet

- 1) Tap [Name] at the top of the list.
- 2) Tap the alphabet to search.

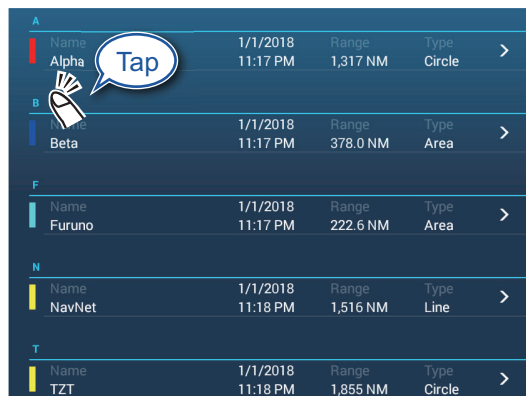

The alphabet search screen appears, showing, in blue, the alphabets available for search.

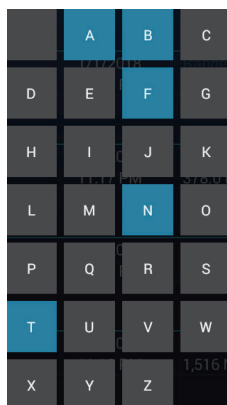

- 3) Tap the alphabet to search. The list is sorted with the alphabet selected at the top of the screen.

4. POINTS, BOUNDARIES

Search by color

- 1) Tap [Color] at the top of the list.
- 2) Tap the color to search.



The color search screen appears, showing the colors available for search. The alphabets under which boundaries are stored are shown in blue.



- 3) Tap the color to search.
The list is sorted with the color selected at the top of the screen.
3. To find information about a boundary or edit a boundary, tap the boundary entry in the list.

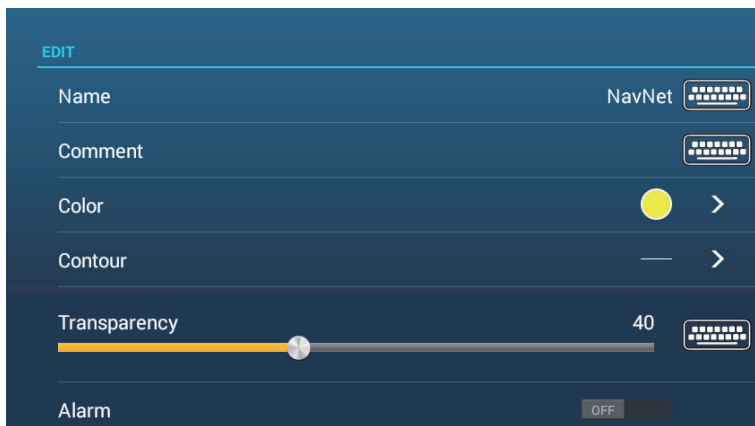

Edit screen for Area, Line boundary

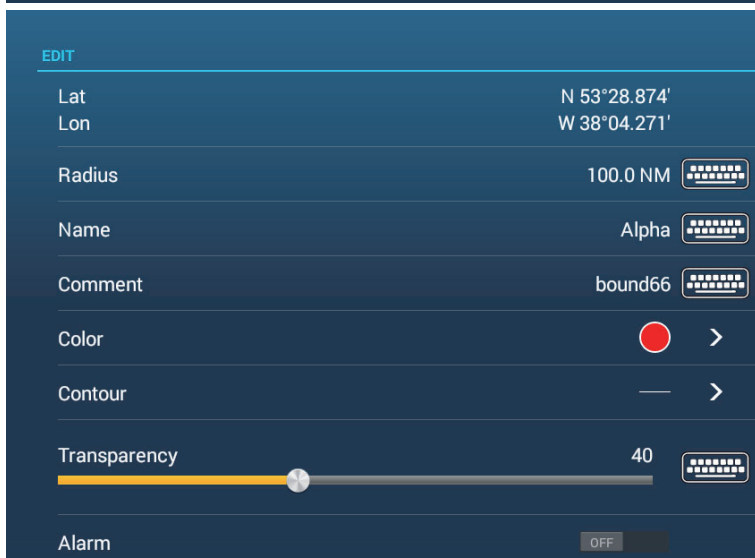

Edit screen for Circle boundary

4. Tap respective item (Latitude, Longitude circle only), Radius (circle only), Name, Comment, Color, Contour, Transparency to change its data.
5. Tap the close button on the title bar to finish.

4.17.5 How to edit boundaries

On-screen boundaries can be edited as shown in this section.

Note: The entire area boundary must be present on the display in order to display it. Zoom to fit the boundary within the screen.

How to edit a boundary on the screen

1. Tap the boundary to edit to show the pop-up menu.

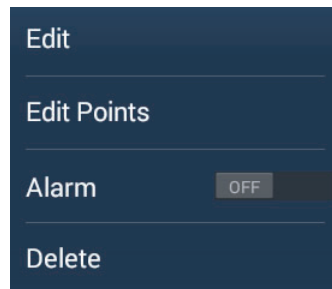

2. Tap [Edit] to show the Edit screen.

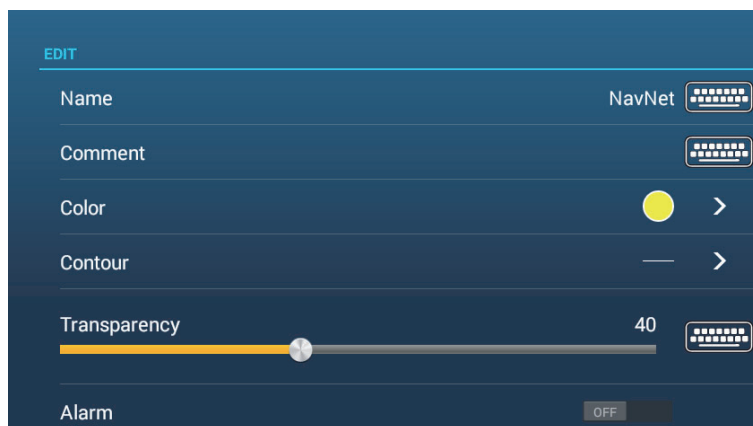

Edit screen for Area, Line boundary



Edit screen for Circle boundary

Go to step 3 to edit a circle, or go to step 7 to edit a line or area.

4. POINTS, BOUNDARIES

3. To change circle position, tap [Lat Lon].
4. Use the software keyboard to enter new position, then tap [✓].
5. To change circle radius, tap [Radius].
6. Use the software keyboard to enter new radius, then tap [✓].
7. To change the name, tap [Name].
8. Enter new name, then tap [✓].
9. To change the comment, tap [Comment].
10. Enter new comment, then tap [✓].
11. To change the color, tap [Color].
12. Tap color desired, tap [✓], then tap [<] on the title bar to go back one layer in the menu.
13. To change line type, tap [Contour].
14. Tap line type desired, tap [✓], then tap [<] on the title bar to go back one layer in the menu.
15. To change boundary transparency, tap [Transparency].
16. Adjust the slider bar at [Transparency], or enter desired value with the software keyboard at [Transparency].
17. Tap the close button on the title bar to finish.

How to edit boundaries collectively via the Boundaries list

The  icon in the title bar on the [Boundaries] list allows you to edit boundaries collectively.

1. On the Home screen, tap [Lists]→[Boundaries] to show the [Boundaries] list.
2. At the top of the list, choose how to sort the boundaries.
3. Tap the  icon. In the example list below the boundaries are sorted by name.

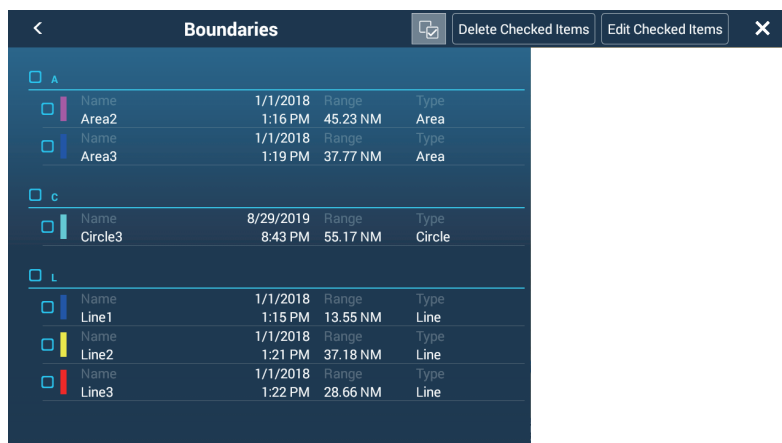

	Name	Range	Type
<input type="checkbox"/>	Area2	1/1/2018 1:16 PM 45.23 NM	Area
<input type="checkbox"/>	Area3	1/1/2018 1:19 PM 37.77 NM	Area
<input type="checkbox"/>	Circle3	8/29/2019 8:43 PM 55.17 NM	Circle
<input type="checkbox"/>	Line1	1/1/2018 1:15 PM 13.55 NM	Line
<input type="checkbox"/>	Line2	1/1/2018 1:21 PM 37.18 NM	Line
<input type="checkbox"/>	Line3	1/1/2018 1:22 PM 28.66 NM	Line

4. Put a checkmark (✓) in the checkbox of the boundary to edit, or check a sort title to edit all boundaries within that title. For example, in the [Boundaries] list above, check “L” to edit all boundaries whose name begins with “L”.

- On the title bar, tap [Edit Checked Items].



- To edit the name, comment, color, or icon, tap the item to edit and then make changes as necessary.
- Tap [Save & Close] to save changes and close the list.

4.17.6 How to add a point to a boundary

You can add points to a line or area type boundary.

- Tap the boundary to which you want to add a point(s).
- Tap [Edit Points] on the pop-up menu. Icons appear on the boundary.
- Tap the position where to add a point, and an icon appears at that position. If necessary, drag the icon to reposition the new point.
- Tap [End Boundary] at the top-right corner to finish.

4.17.7 How to move a point on a boundary

You can move a point on a boundary by two methods, on-screen and on the [Boundaries] list.

How to move an on-screen point

- Tap the boundary to which you want to add a point(s).
- Tap [Edit Points] on the pop-up menu. Icons appear on the boundary.
- For area or line type boundary:** Drag the icon to new location.
For circle boundary: Drag the “resize” or “relocate” icon to new location.
- Tap [End Boundary] at the top-right corner to finish.

How to move a point from the Edit screen

- Tap the boundary to which you want to add a point(s).
- Tap [Edit] on the pop-up menu to show the Edit menu.
- Tap [Edit Points] to show the [Boundary Detail] screen.
- Tap the point whose position you want to change to show the [Position] screen.
- Tap [Lat Lon] to show the software keyboard.
- Use the software keyboard to enter new position, then tap [✓].
- Tap the close button on the title bar to finish.

4.17.8 How to delete a point from a line or area boundary

You can delete a point from a line or area boundary.

1. Tap the line or area boundary to process.
2. Tap [Edit Points] on the pop-up menu.
Icons appear on the boundary.
3. Tap the icon belonging to the point to delete, then tap the [Delete] indication.
4. Tap [End Boundary] at the top-right corner to finish.

4.17.9 How to set an alarm for a boundary

How can get an audiovisual alarm when your vessel approaches a boundary within the specified distance.

1. Open the [Alarm] menu, then find and set [Own Ship Alarm Zone] to [ON].
2. Tap [Own Ship Alarm Zone Warning] to show the software keyboard.
3. Enter the distance for the alarm, then tap [✓]. When your vessel is within this distance to the boundary, the audiovisual alarm is released.
4. Tap the close button on the title bar.
5. On the chart plotter tap the boundary for which you want to get the alarm, and a pop-up menu appears.
6. Turn [Alarm] to [ON]. Note that the alarm for a boundary can be turned on/off from the Edit screen.

When your vessel is within the distance set at step 3, a black dashed black line runs between the own ship icon and the boundary as shown in the figure below.

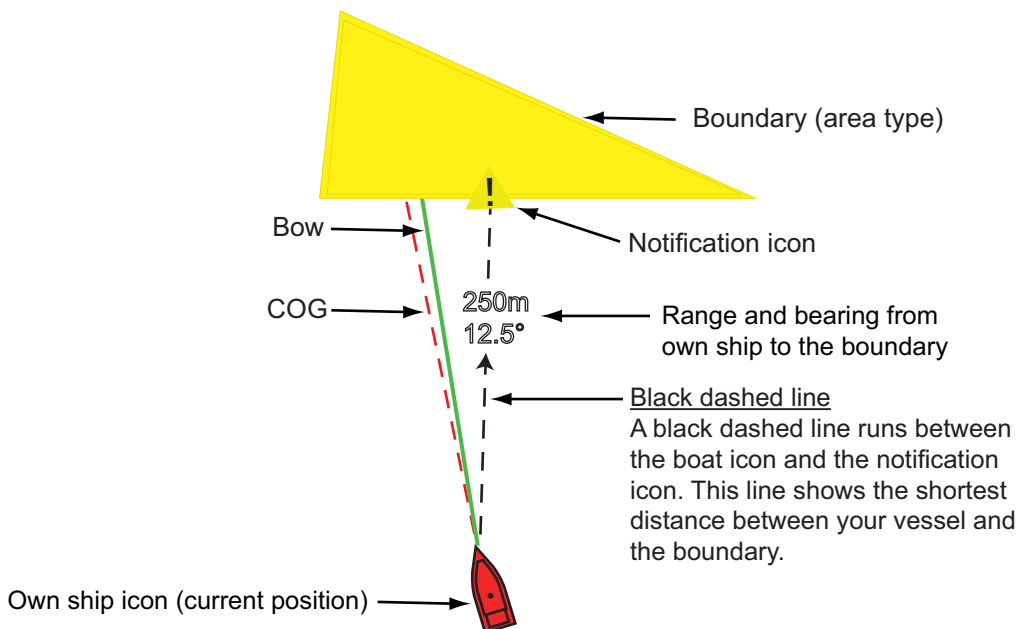

- The status bar at the top of the screen shows the message “Near Alarm Zone: Area” (or Circle, or Line), and the audio alarm sounds. The audio alarm can be silenced by tapping the status bar.
- The boundary is highlighted.
- A dashed black line runs between the own ship icon and the notification icon. This line shows the shortest distance between own ship and the boundary.

- The range and bearing to the boundary are overlaid on the black line.
- If the Data box has the item [Boundary Alarm Zone], the distance to the boundary appears in the Data box, like the example shown below.

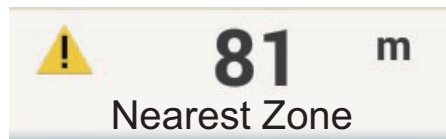

In the case of areas and circles, when the ship enters the boundary, the boundary turns red and flashes. Also, in the status bar, the message “In Alarm Zone: Area” (or Circle) appears and the audible alarm sounds.

In the case of a line, when your ship crosses the line, in addition to the notification message, the status bar shows the message "Boundary Line Crossed" appears in the status bar and the audible alarm sounds.

4.17.10 How to find the number of boundary points used

Go to the Home screen, then tap [Settings]→[General]. Find [Areas & Lines] and [Circles] in the [DATA USAGE] section. In the example below, three areas/lines and two circles have been used.

DATA USAGE	
Points	9 / 30000
Routes	1 / 200
Areas & Lines	3 / 100
Circles	2 / 100
Photos	0 / 1000
Catches	0 / 1000
Track Points	13794 / 30000

4.17.11 How to display a boundary at the screen center

Do the following to move a boundary to the screen center.

1. Go to the Home screen, then tap [Lists]→[Boundaries] to show the [Boundaries] list.
2. Tap the boundary that you want to place at the screen center.
3. Tap [Find on Chart].

The chart plotter display appears, with the selected boundary at the screen center.

4.17.12 How to delete boundaries

How to delete an on-screen boundary

Tap a boundary line to show the pop-up menu. Tap [Delete] to delete the line from the screen.

How to delete a boundary via the Boundaries list

1. Go to the Home screen, then tap [Lists]→[Boundaries].
2. Tap the boundary to delete.
3. Tap [Delete].
4. Tap the close button on the title bar to close the menu.

How to delete boundaries collectively via the Boundaries list

The  icon in the title bar on the [Boundaries] list allows you to delete boundaries collectively.

1. On the Home screen, tap [Lists]→[Boundaries] to show the [Boundaries] list.
2. At the top of the [Boundaries] list, choose how to sort the boundaries.
3. Tap the  icon. In the example list below the boundaries are sorted by name.

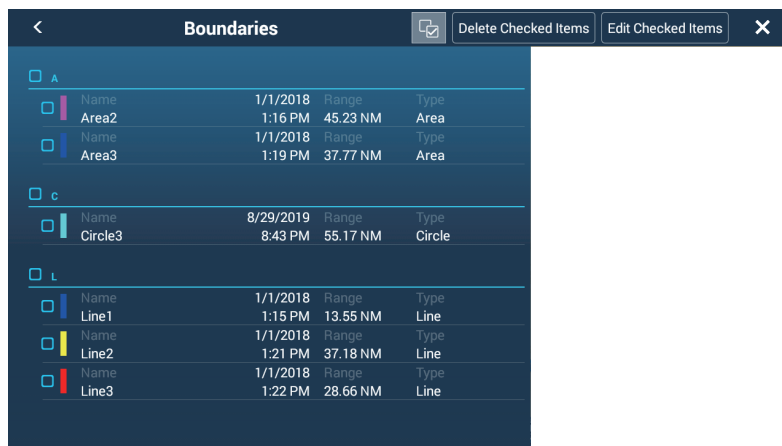

	Name	1/1/2018	Range	Type	
<input type="checkbox"/>	Area2	1:16 PM	45.23 NM	Area	
<input type="checkbox"/>	Area3	1:19 PM	37.77 NM	Area	
<input type="checkbox"/>	Circle3	8/29/2019	8:43 PM	55.17 NM	Circle
<input type="checkbox"/>	Line1	1/1/2018	1:15 PM	13.55 NM	Line
<input type="checkbox"/>	Line2	1/1/2018	1:21 PM	37.18 NM	Line
<input type="checkbox"/>	Line3	1/1/2018	1:22 PM	28.66 NM	Line

4. Put a checkmark (✓) in the checkbox of the boundary to delete, or check a sort title to delete all boundaries within that title. For example, in the [Boundaries] list above, check "L" to delete all boundaries whose name begins with "L".
5. On the title bar, tap [Delete Checked Items]. A message asks if you are sure to delete checked boundaries. Tap [OK] to delete the boundaries.

How to delete all boundaries

1. Go to the Home screen, then tap [Settings]→[Points & Boundaries].
2. Tap [Delete All User Objects]. The message "Are you sure you want to delete all your user objects (marks, routes, boundaries, ...) from this device and all other networked devices? If the cloud synchronization is enabled, this will also remove all user objects from any devices connected with the same TIMEZERO account. This action cannot be undone." appears.
3. Tap [OK].
4. Tap the close button on the title bar to close the menu.

5. ROUTES

5.1 What is a Route?

In order to sail from one point to another, it is necessary to change the course several times. The line that connects any two points on a journey is called a “leg” and the total legs on a journey is called a “route”. When you steer along a route, your NavNet TZ-touch3 automatically switches to the next point on the route, and provides information for steering, such as direction and distance to a point.

The equipment can store a maximum of 200 routes, with a maximum of 500 points per route. With many routes on-screen, the display can become cluttered. To prevent this, inactive routes are collapsed and marked with the "sleeping route" icon, pictured below.



Once you have created a route, you can “navigate” along that route. The route used for navigation is called the “active route”. During route navigation, the route leg currently being navigated is displayed as a solid purple line with several moving arrows that move in the direction to follow. Route legs which have been navigated are marked with a light gray line.

On-screen routes can be edited from the pop-up menu. The following editing features are available:

- Insert route points in a route
- Move route points in a route
- Delete route points from a route
- Extend a route
- Find information about a route
- Delete a route
- Restart navigation after setting new course
- Follow a route in the reverse direction

Note: Active routes can be shared with other NavNet TZtouch3 units via LAN. Data is shared automatically; no operation is required.

5.2 How to Create a Route

5.2.1 How to create a route by selecting positions

1. On the chart plotter screen, tap the location for the 1st point in the route to display the pop-up menu.
2. Tap [New Route]. The flag mark () appears on the selected position and the route information box appears (at the top of the screen).
3. Tap the next route point in the route. A light-blue line with arrow runs between the previous route point and the next route point. The arrow points in the direction of route flow.
4. Tap the next route point in the route. Repeat this step to enter all route points. The route information box shows the point's range and bearing, the distance to final destination, and the time-to-go to the last point.

Lat	N 44°16.618'
Lon	E 174°11.510'
Range	15.99 NM
Bearing	356.4 ° R
New Point	
Goto	
New Route	
New Boundary >	
Tide	
Chart Info	
Move Boat	

Navigation bar

- RNG: Range between last two points
- BRG: Bearing between last two points
- DTA: Distance to arrival
- TTA: Time to arrival

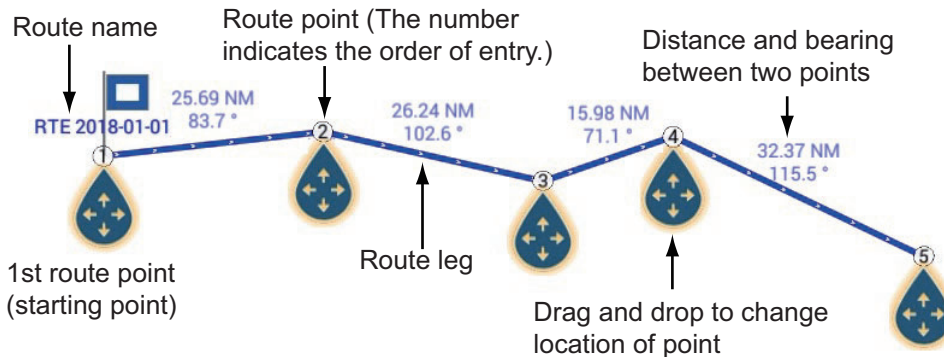
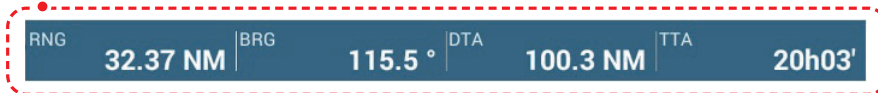

5. At the last route point, tap [End Route] at the top right-hand corner of the screen to complete the route.
6. The window for entering route name appears. Enter route name, then tap [✓] to confirm. The route information box shows, to the last waypoint, the range, time-to-go, estimated time of arrival, and SOG.

Note 1: The route created above is called an "inactive route". When you create a new route or tap another route, that route becomes a "sleeping route".



Note 2: The points used to create a route by the above method are not saved to the [Points] list.

5.2.2 How to create a route with points

You can create a route with points (including event marks) you have previously entered.

1. Tap a point to display the pop-up menu.
2. Tap [New Route]. The flag mark as below appears on the point. The flag mark appears on the selected position and the route information box appears (at the top of the screen).



Lat	N 44°37.767'
Lon	E 171°59.266'
Range	13.98 NM
Bearing	59.9 °
Goto	
Move	
New Route	
Edit	
Delete	

3. Tap the point to be the next route point. A light-blue line with arrow runs between the previous point and the next route point. The arrow points in the direction of route flow.
4. Tap the point to be the next route point. Repeat this step to enter all route points. The route information box shows the point's range and bearing, the distance to final destination, and the time-to-go to the last point.

Navigation bar

- RNG: Range between last two points
- BRG: Bearing between last two points
- DTA: Distance to arrival
- TTA: Time to arrival

RNG	22.26 NM	BRG	112.5 °	DTA	60.05 NM	TTA	12h01'
-----	----------	-----	---------	-----	----------	-----	--------

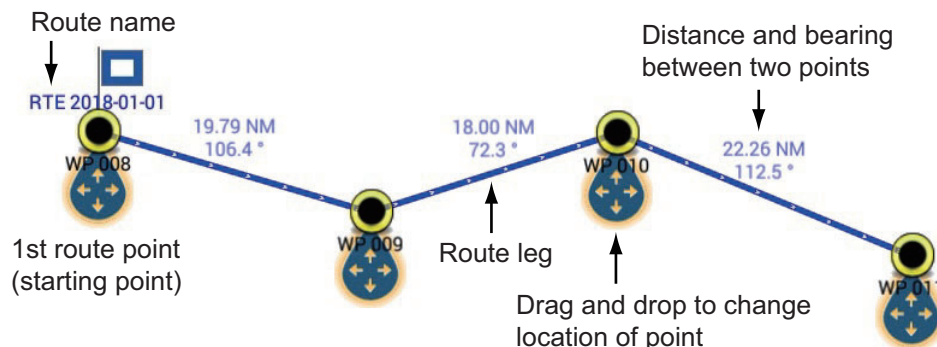

5. At the last route point, tap [End Route] at the top right-hand corner of the screen to complete the route.
6. The window for entering route name appears. Enter route name then tap [✓] to confirm. The route information box shows, to the last waypoint, the range, time-to-go, estimated time of arrival, and SOG.

Note: The route created above is called an "inactive route". When you create a new route or tap another route, that route becomes a "sleeping route".

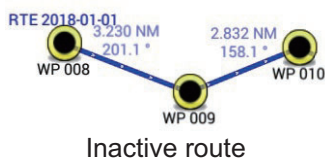

5.2.3 How to create a route from the Points list

1. Go to the Home screen, then tap [Lists]→[Points].
2. Tap the point to be the first point in the route.
3. Tap [Add to Route], then tap [<] on the title bar to return one layer in the list.
4. Repeat steps 2-3 to enter all required points. The route is drawn on the preview screen on the right-hand side.
5. Tap the close button on the title bar to close the [Points] list.

5.3 How to Edit a Route

5.3.1 How to insert a route point on a route

You can insert a new route point on a route leg as follows.

1. Tap a position on a route leg where to insert a route point.
2. Tap [Insert] on the pop-up menu. The compass symbol marks the position selected. The route point is numbered according to its position in the route, and the succeeding route points are renumbered.

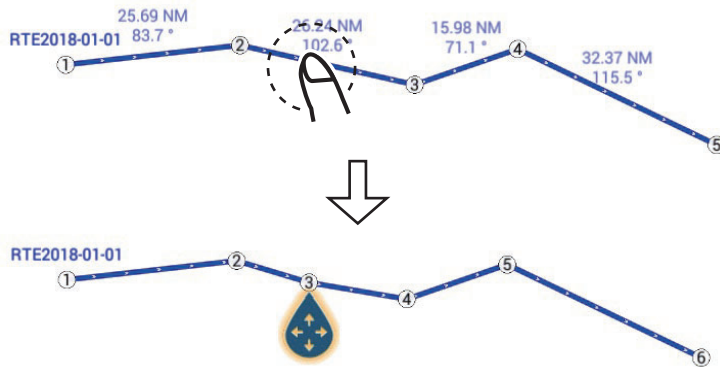

Lat	N 44°16.769'
Lon	E 175°01.888'
Range	131.0 NM
Bearing	6.1 ° R
Start Nav	
Start From Here	
Reverse	
Insert	
Extend	
Delete	
Edit	

3. Tap [End Move] at the top right-hand corner of the screen.

5.3.2 How to move a route point on a route

You can move a route point on a route as follows.

1. Tap a route point on a route to display the pop-up menu.
For example, point #3 in the figure below will be moved.

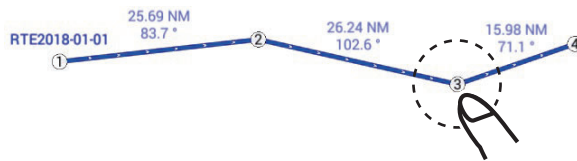

2. Tap [Move]. The selected route point is highlighted.



3. Move the route point to the new position by dragging the route point or tapping the new position.

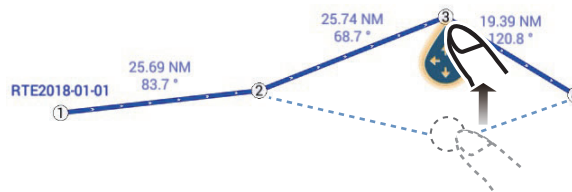

4. Tap [End Move] at the top right-hand corner of the screen.

Lat	N 44°13.713'
Lon	E 175°22.723'
DTA	51.94 NM
TTA	10h23'
Start Nav	
Move	
Goto	
Edit	
Delete	

5.3.3 How to delete a point (incl. route point) on a route

You can delete a point on a route.

1. Tap the point to show the pop-up menu.
2. Tap [Delete]. The selected point is deleted, and the succeeding route points are renumbered.

Note: If the point tapped at step 1 is a point icon, only the point icon is erased. To erase the route point, do steps 1 and 2 again.

5.3.4 How to extend a route

You can extend a route from the last route point on the route.

1. Tap a route leg to display the pop-up menu.
2. Tap [Extend].
3. Tap a position. A light-blue line with arrow runs from the last route point to the selected position.
4. Repeat step 3 to enter more route points, if necessary.
5. At the last route point, tap [End Route] at the top right-hand corner of the screen to complete the route and save the route to the [Routes] list.

5.4 Routes List

The created routes are stored in the [Routes] list, where you can edit or see the route data. The list stores the following route data for each route:

- Name of route
- Total distance of route
- Color of route
- Comment for route
- Number (ID) of each route point
- Bearing to steer (to route point)
- Planning route speed (see section 5.15)
- Distance between legs and total distance
- TTG between legs and total TTG

How to show the Routes list

1. Go to the Home screen, then tap [Lists]→[Routes] to open the [Routes] list.

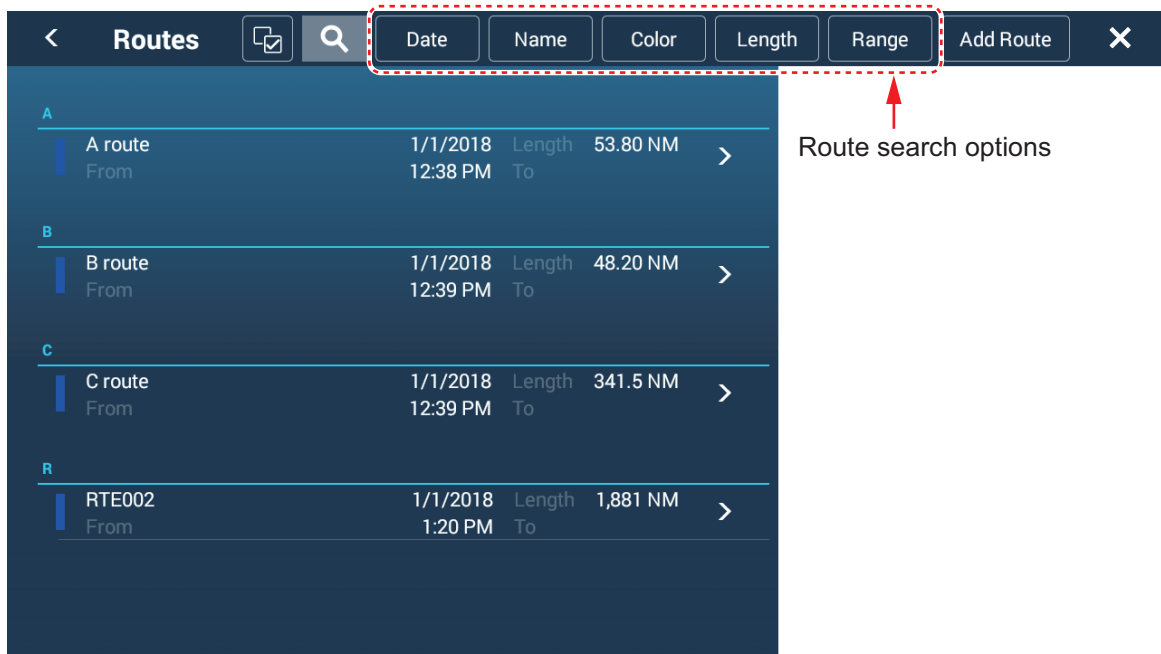

2. To search the list, follow the applicable procedure on the next several pages.
 - [Date]** Sort by date registered, in oldest-to-newest order.
 - [Name]**: Sort by point name, in alphabet order.
 - [Color]**: Sort by color.
 - [Length]**: Sort by route length, from shortest to longest.
 - [Range]**: Sort by range from own ship, from nearest to farthest.

How to search routes

Routes can be searched by character string, name, and color.

Search by character string

- 1) Tap the magnifying glass icon at the top of the screen to show the software keyboard.

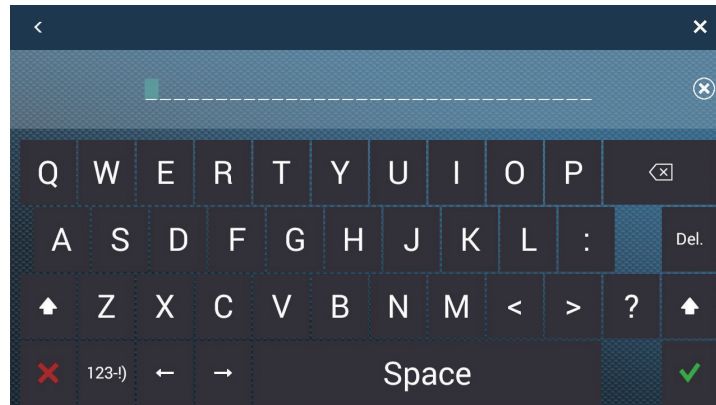

- 2) Enter search string (route's full name, or 2-3 characters), then tap [✓].

The route searched appears in the [Routes] list.

Search by name

- 1) Confirm that the sort method is selected to [Name].
- 2) Tap the appropriate alphabet in the list.



The search keyboard appears, with the search-able alphabets shown in blue.

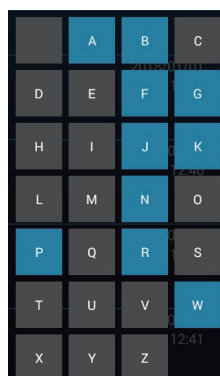

- 3) Tap the alphabet to search.

5. ROUTES

Search by color

- 1) Confirm that the sort method is selected to [Color].
- 2) Tap the appropriate route color.



The color search display appears.



- 3) Tap the color to search. The routes corresponding to the color tapped appear in the [Routes] list.
3. Tap a route to find detailed information or to edit the route.

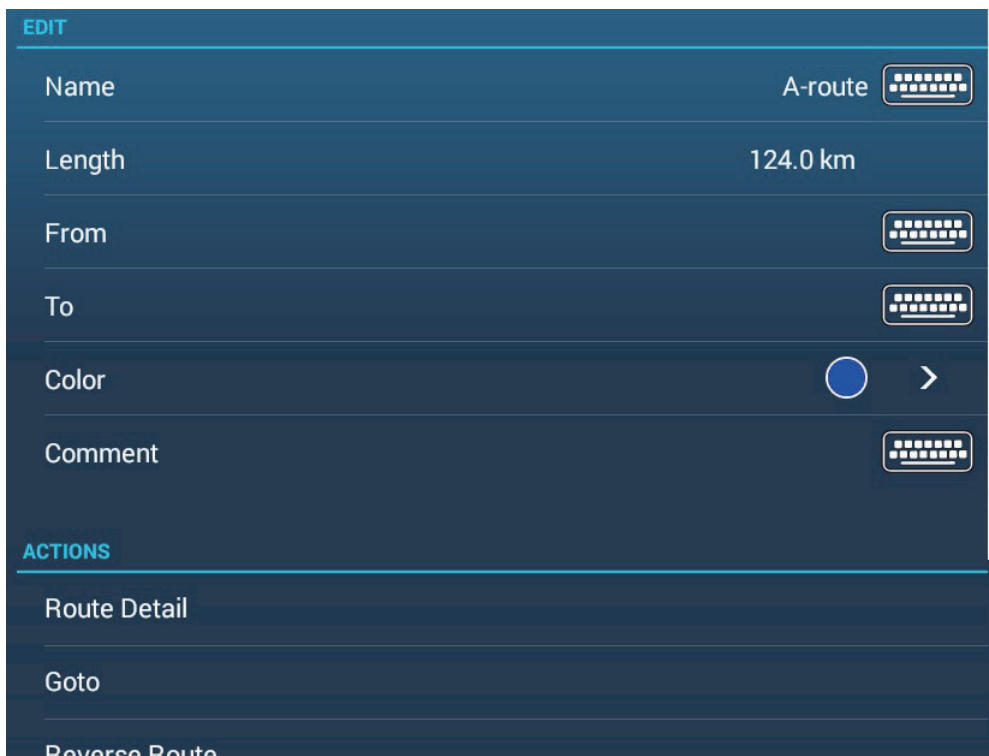

4. Tap the applicable item ([Name], [Length], [From], [To], [Color],[Comment]) to edit its content.

5. To find detailed information about a route, tap [Route Detail] to show route details.

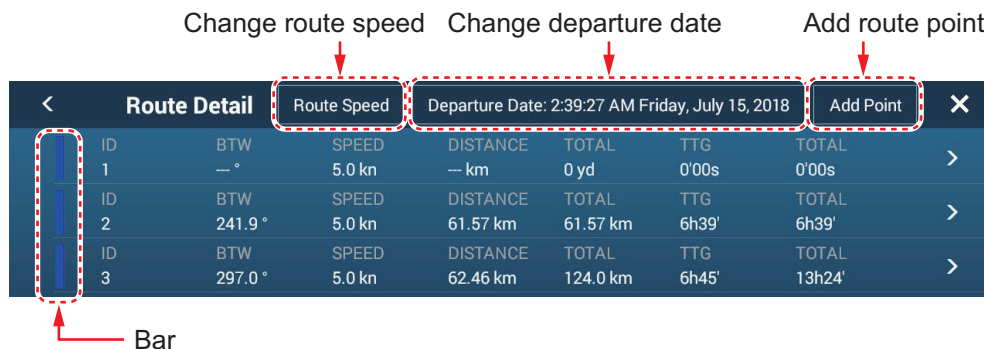

[ID]: Point no. ([Start] or [Goto])

[BTW]: Bearing to Goto point

[SPEED]: Speed to Goto point

[DISTANCE]: Distance from starting point

[TOTAL]: Total distance from start to Goto point

[TTG]*: Time to go to the Goto point, using speed shown in [SPEED] column.

[TOTAL]*: The time from start to the Goto point.

* Shown only when navigating a route

Note: Detailed information can also be displayed as follows:

- From the Home screen, tap [Lists]→[Planning Route Detail].
- Tap an on-screen route, then tap [Edit]→[Route Detail] on the pop-up menu.

6. To edit a route from the [Route Detail] screen, tap the point to edit.

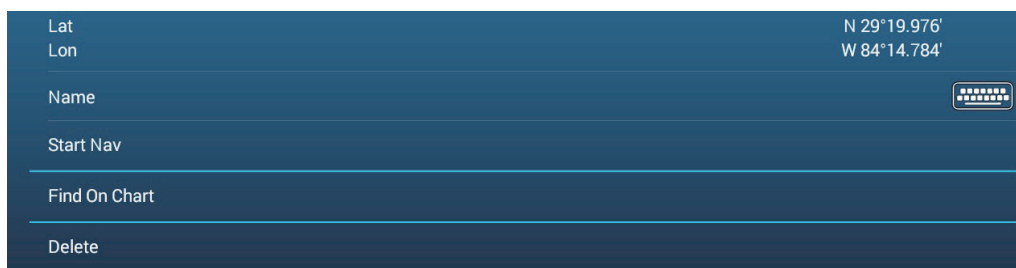

[Lat Lon]: Edit the latitude and longitude position of the point.

[Name]: Change the name of the point.

[Start Nav]: Start navigation from the point selected.

[Find on Chart]: Show the route of the selected point at the center of the chart plotter display.

[Delete]: Delete the selected point. Control is returned to the [Route Detail] screen and the points of the route are re-numbered.

7. Tap the close button on the title bar to finish.

How to edit routes collectively via the Routes list

The  icon in the title bar allows you to edit routes collectively.

1. On the Home screen, tap [Lists]→[Routes] to show the [Routes] list.
2. Use the sort buttons to sort the list as desired.
3. Tap the  icon. In the example list below the routes are sorted by name.

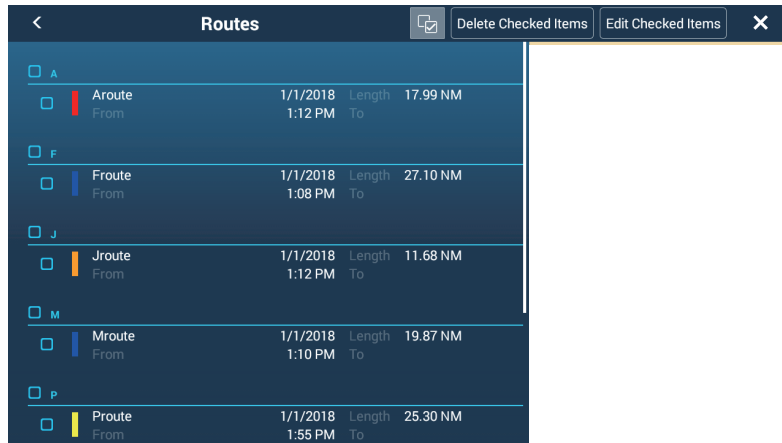

4. Put a checkmark (✓) in the checkbox of the route to edit, or check a sort title to edit all routes within that title. For example, in the [Routes] list above, check “A” to edit all routes whose name begins with “A”.
5. On the title bar, tap [Edit Checked Items] to edit the checked routes. A screen similar to the one shown below appears.

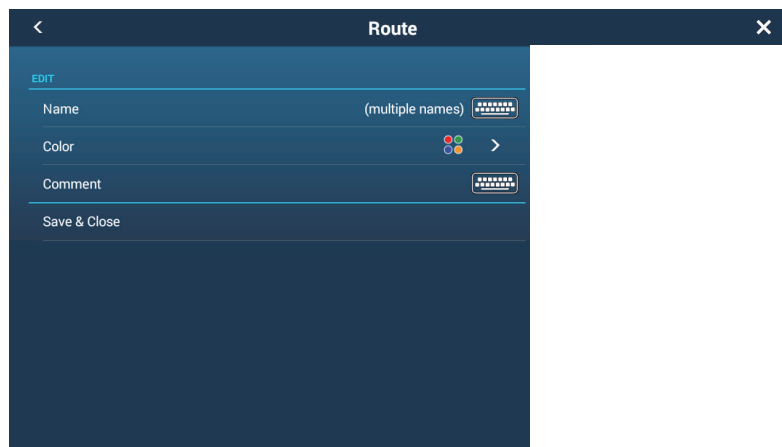

6. Edit route name, color or comment as appropriate.
7. Tap [Save & Close] to confirm changes and close the list.

5.5 How to Find Number of Routes Created

Go to the Home screen, then tap [Settings]→[General]. Find [Routes] in the [DATA USAGE] section. In the example below, 10 routes out of 200 have been created.

DATA USAGE	
Points	7 / 30000
Routes	10 / 200
Areas & Lines	2 / 100
Circles	4 / 100
Photos	6 / 1000
Catches	2 / 1000
Track Points	42 / 30000

5.6 How to Find a Route on the Chart

You can easily find the location of a route from the [Routes] list. The selected route is put at the center of the active chart plotter display.

1. Go to the Home screen, then tap [Lists].
2. Tap [Routes] to open the [Routes] list.
3. Tap a route then tap [Find On Chart] from the options. The menu closes then the selected route is put at the center of the chart plotter display.

Note: If a split-screen chart plotter display is in use when searching for a route on the chart, the full-screen chart plotter display is restored and the route appears at the center of the screen.

5.7 How to Delete a Route

You can delete routes individually or collectively. An active route cannot be deleted.

5.7.1 How to delete a route on the screen

Tap a route leg of the route to delete to show the pop-up menu, then tap [Delete].

Note: A route currently selected for navigation cannot be deleted.

5.7.2 How to delete a route via the Routes list

1. Go to the Home screen, then tap [Lists]→[Routes].
2. Tap the route to delete then tap [Delete]. The route disappears from both the screen and the [Routes] list.
3. Tap the close button on the title bar to finish.

5.7.3 How to delete routes collectively via the Routes list

The  icon in the title bar on the [Routes] list allows you to delete routes collectively.

1. On the Home screen, tap [Lists]→[Boundaries] to show the [Boundaries] list.
2. At the top of the [Boundaries] list, choose how to sort the boundaries.
3. Tap the  icon. In the example list below the routes are sorted by name.

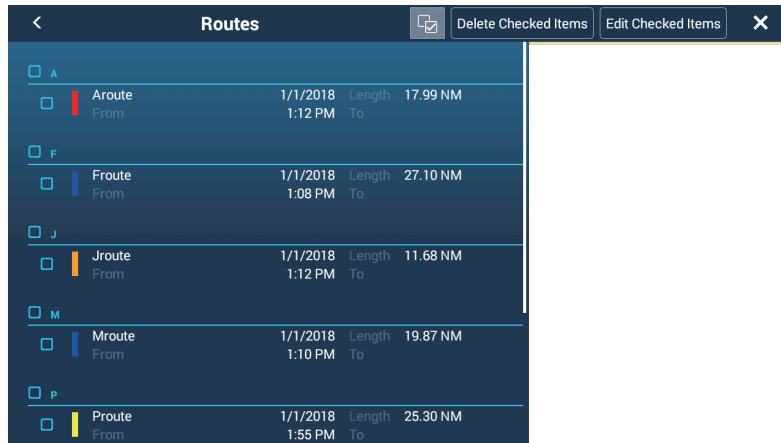

4. Put a checkmark (✓) in the checkbox of the route to delete, or check a sort title to delete all routes within that title. For example, in the [Routes] list above, check “J” to delete all routes whose name begins with “J”.
5. On the title bar, tap [Delete Checked Items]. A message asks if you are sure to delete checked routes. Tap [OK] to delete the routes.

5.7.4 How to delete all routes

1. Go to the Home screen, then tap [Settings]→[Points].
2. Tap [Delete All User Objects] menu. The message "Are you sure you want to delete all your user objects (marks, routes, boundaries, ...) from this device and all other networked devices? If the cloud synchronization is enabled, this will also remove all user objects from any devices connected with the same TIMEZERO account. This action cannot be undone." appears.
3. Tap [OK].
4. Tap the close button on the title bar to finish.

5.8 How to Show or Hide All Routes

All routes (including the route information box) can be shown or hidden. Open the Layers menu, then turn [Routes] on or off as required.

Note 1: An active route cannot be hidden from the screen unless route following is stopped.

Note 2: Inactive routes can be placed at either the arrival or departure location. Open the Layers menu, then activate [Departure] or [Arrival] (below the [Routes] flipswitch).

5.9 How to Set Route Density

If you display all your routes, the screen can become cluttered with routes. To prevent this, set route density as shown below to limit the number of routes to show.

1. On the Home screen, tap [Settings]→[Routes]→[Routes Density] to show the following options menu.

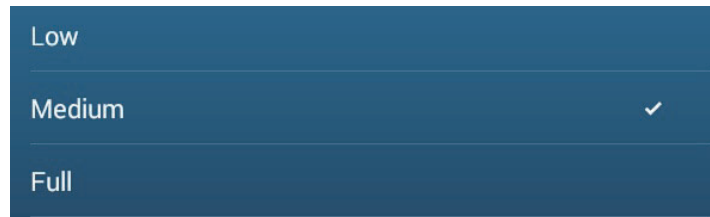

2. Tap desired route density. [Low] is the lowest route density, and [Full] displays all routes.
3. Tap the close button on the title bar to close the menu.

5.10 How to Follow a Route

Before you follow a route, make sure that the path to the route is clear. Make sure to zoom your chart to check for hazards that do not appear on a smaller scale.

5.10.1 How to follow an on-screen route

1. Tap a route leg of the route to follow to show the pop-up menu.
2. Tap [Start Nav]. The route now looks something like the one show in the figure below.

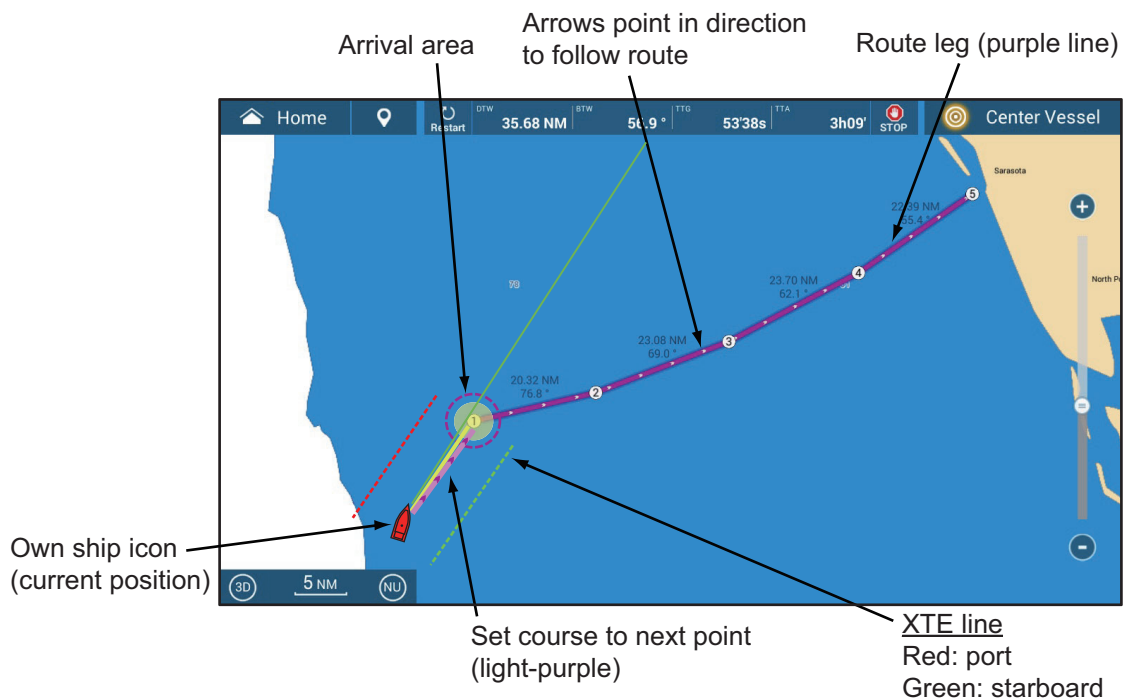

The following occurs:

- The color of the route becomes purple, and arrows on the route point in the direction in which to follow the route.
- The Goto point (1st route point) is highlighted.
- A solid purple line with arrows connects between current position and the points on the route. This line indicates the set course. A solid yellow line runs between runs between current position and the destination. This line shows the shortest distance to the destination.
- Points are switch according the waypoint switching mode set on the menu. To select the mode, go to the Home screen, then tap [Settings]→[Routes]→ [WPT Switch Mode]. Select [Circle and Cross Line], [Circle], or [Cross Line] as appropriate.
- The XTE lines, red for port side, green for starboard side, appear. You can show or hide these lines and set their width with [Display XTE Lines] and [XTE Value] respectively in [Routes] menu.

Note: If you want to be notified when you reach a Goto point, turn on [Waypoint Crossing Notification] on [Routes] of the menu (see subsection 5.11.8). Then the message "Waypoint Crossing" appears when you reach a Goto point. For the arrival timing, see subsection 5.11.5.

5.10.2 How to follow a route selected from the Routes list

1. Go to the Home screen, then tap [Lists]→[Routes].
2. Tap the route to follow then tap [Goto].

The following occurs:

- The color of the route becomes purple, and arrows on the route point in the direction in which to follow the route.
- The Goto point (1st route point) is highlighted.
- A solid purple line with arrows connects between current position and the points on the route. This line indicates the set course. A solid yellow line runs between runs between current position and the destination. This line shows the shortest distance to the destination.
- Points are switch according the waypoint switching mode set on the menu. To select the mode, go to the Home screen, then tap [Settings]→[Routes]→ [WPT Switch Mode]. Select [Circle and Cross Line], [Circle], or [Cross Line] as appropriate.
- The XTE lines, red for port side, green for starboard side, appear. You can show or hide these lines and set their width with [Display XTE Lines] and [XTE Value] respectively in [Routes] menu.

Note: If you want to be notified when you reach a Goto point, turn on [Waypoint Crossing Notification] in the [Routes] menu (see subsection 5.11.8). Then the message "Waypoint Crossing" appears when you reach a Goto point. For the arrival timing, see subsection 5.11.5.

5.10.3 How to start navigation from a route point

1. Tap the route point of the route from where to start navigation. The pop-up menu appears; tap [Start Nav] on the pop-up menu.
2. Tap [Start Nav].
In the example figure below, route point "3" was tapped.

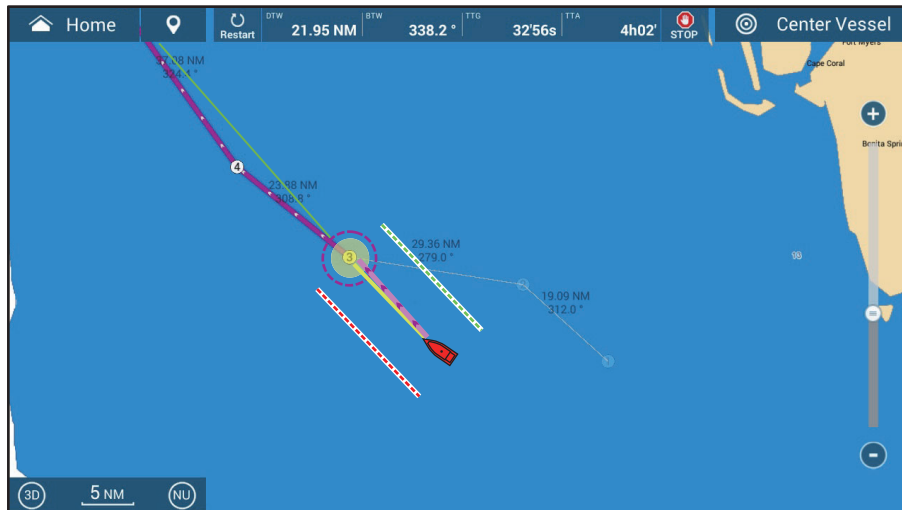

After tapping a route point, the following occurs:

- The route point "3" is selected to start navigation from, and is highlighted. Route points other than No. 3 are connected with a purple line. The arrows on the route point in the direction of route flow.
- The line between route points 1 and 2 and 2 and 3 are greyed out.
- A solid purple line with arrows connects between current position and the points on the route. This line indicates the set course. A solid yellow line runs between runs between current position and the destination. This line shows the shortest distance to the destination.
- The arrival area marker appears if activated on the menu (see subsection 5.11.5).
- The XTE lines, red for port side, green for starboard side, appear. You can show or hide these lines and set their width with [Display XTE Lines] and [XTE Value] respectively in [Routes] menu.

Note 1: If you want to be notified when you reach a Goto point, turn on [Waypoint Crossing Notification] in the [Routes] menu (see subsection 5.11.8). Then the message "Waypoint Crossing" appears when you reach a Goto point. For the arrival timing, see subsection 5.11.5.

Note 2: You can also start navigating a route from any location on a route leg. Tap anywhere on a route leg to show the pop-up menu, then tap [Start from Here] to have that location become the destination.

5.10.4 How to show the detailed information about a route

1. Tap a route leg of the route to show the pop-up menu.
2. Tap [Detail] to show the [Route Detail] window.

Route Detail							
ID	BTW	SPEED	DISTANCE	TOTAL	TTG	TOTAL	
Start	— °	5.0 kn	0 yd	0 yd	0'00s	0'00s	>
1	326.4 °	5.0 kn	5.899 km	5.899 km	5'26s	5'26s	>
2	312.0 °	5.0 kn	35.35 km	41.25 km	28'38s	34'04s	>
3	279.0 °	5.0 kn	54.37 km	95.62 km	44'02s	1h18'	>
4	308.8 °	5.0 kn	44.23 km	139.9 km	35'49s	1h54'	>
5	324.4 °	5.0 kn	68.67 km	208.5 km	55'37s	2h50'	>

3. Tap the close button on the title bar to finish.

About the Route Detail window

The colored bars at the left edge of the window denote the status of each route point.

Gray: A route point already transited.

Yellow: The route point your vessel is currently heading toward.

Purple: Route points other than the current destination.

[ID]: [Start], or route point number

[BTW]: Bearing To Waypoint

[SPEED]: Speed used to calculate route details

[DISTANCE]: Distance to waypoints

[TOTAL]: Total distance of route

[TTG]: Time to Go between each route point*

[TOTAL]: Total time to go from start*

* Calculation based on [SPEED] value.

5.11 Operations Available When You Follow a Route

5.11.1 How to restart navigation

When you follow a route, you can restart the navigation to the next route point on the route from current location.

When you steer to keep away from an obstruction or the ship drifts, you go off course as shown in Line 1 in the figure. If you do not need to return to the original course, you can go to the route point from the current position as shown in Line 2 in the figure.

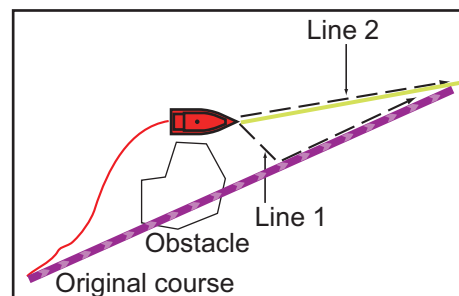

There are two methods two restart navigation:

From the navigation bar

Tap the [Restart] button.

From the pop-up window

1. Tap a route leg, route course or the “shortest distance” line (yellow) to show the pop-up window.
2. Tap [Restart].
The route start position for the route moves to the current position.

5.11.2 How to follow a route in the reverse direction

You can follow a route in reverse order. This helps you return along the same path.

Note: This function is not available for an active route.

1. Tap the route that you want to transverse in the opposite order to show the pop-up window.
2. Tap [Reverse].
The arrows on the route legs are in reverse direction and the numbers of the route points are in reverse order.

5.11.3 How to stop following a route**From the navigation bar**

Tap the [STOP] button.

From the pop-up window

1. Tap a route leg, route course or the “shortest distance” line (yellow) to show the pop-up window.
2. Tap [Stop Nav].
The arrival area, XTE lines, set course (purple line) and yellow line are erased from the screen. The default color for the route is restored.

Note: You can also stop following a route from the Slide-out menu, with [Stop Nav].

5.11.4 How to skip a point on a route

You can skip a route point to go to the succeeding route point in the route. Open the Slide-out menu, then tap [Route] and [Skip Next]. The current route point is skipped then the next route point becomes the destination. The skipped route point is greyed out.

5.11.5 Waypoint switching mode

When you arrive to a route point, your unit automatically changes to the next route point according to the waypoint switching mode selected on the menu.

[Cross Line]: Change the waypoint when the ship moves through an imaginary cross line (vertical line) that passes through the center of the destination point.

[Circle]: Change the waypoint when the ship comes within the circle.

[Circle and Cross Line]: Change the waypoint when one of the above two conditions is met.

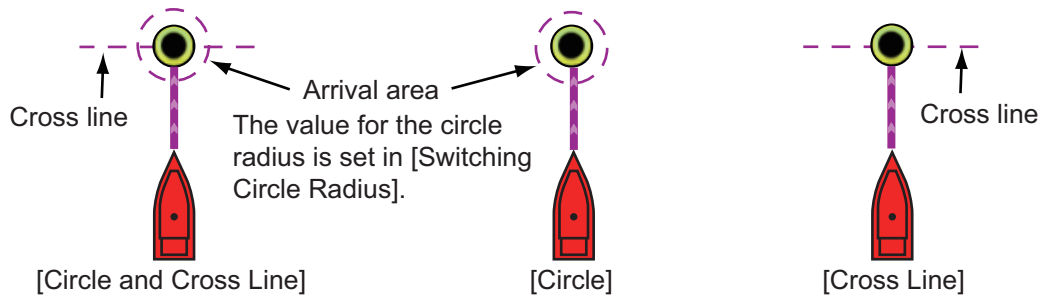

1. Go to the Home screen, then tap [Settings]→[Routes]→[WPT Switch Mode].
2. Tap [Circle and Cross Line], [Circle] or [Cross Line]. For [Circle and Cross Line] or [Circle], go to step 3. For [Cross Line], go to step 6.
3. Tap [<] on the title bar to go back one layer in the menu.
4. Tap [Switching Circle Radius] to show the software keyboard.
5. Enter the radius for the circle, then tap [✓]
6. Tap the close button on the title bar to finish.

5.11.6 How to automatically zoom a route

You can get automatic range change after you have moved past the Goto point. Use this feature to find the next Goto point in the route when the next Goto point is not within the current display range.

1. Go to the Home screen, then tap [Settings]→[Routes].
2. Turn [Route Auto Zoom] on or off.
3. Tap the close button on the title bar to finish.

5.11.7 XTE lines

The color of the XTE line is red for the port side, green for the starboard side. You can show or hide these lines and set their distance from own ship as follows.

1. Go to the Home screen, then tap [Settings]→[Routes].
2. Turn [Cross Track Error Lines] on or off. For [ON], go to the next step. For [OFF], tap the close button on the title bar to finish.
3. Tap [Cross Track Error Value] to display the software keyboard.

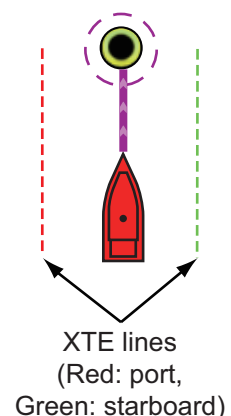

4. Set the distance of the XTE lines from your ship then tap [✓]. The XTE alarm sounds (if active) when your ship veers off course by the amount set here.
5. Tap the close button on the title bar to finish.

5.11.8 Waypoint arrival notification

The waypoint arrival notification feature releases audio and visual notifications when your ship reaches a Goto point. For the arrival timing, see subsection 5.11.5. The notification message "Waypoint Crossing" appears. Activate or deactivate this feature as follows.

1. Go to the Home screen, then tap [Settings]→[Routes].
2. Turn [Waypoint Crossing Notification] on or off.
3. Tap the close button on the title bar to finish.

5.11.9 End of route notification

The end of route notification feature releases audio and visual notifications when your ship reaches the end of a route. For the arrival timing, see subsection 5.11.5. The notification message "End of Route" appears. Activate or deactivate this feature as follows.

1. Go to the Home screen, then tap [Settings]→[Routes].
2. Turn [End of Route Notification] on or off.
3. Tap the close button on the title bar to finish.

5.11.10 How continue navigation at end of route

When you arrive at the final destination, you can keep the destination and route active. For example, if you set a destination on a small reef and continue fishing while going back and forth between the destinations, this function can save you from having to set the destination many times.

1. Go to the Home screen, then tap [Settings]→[Routes]→[End of Route Operation].
2. Tap [Continue Navigation].

Go to the Home screen, then tap [Settings]→[Routes]→[End of Route Operation]. The route is not canceled when arriving at the final destination, and the set course, XTE lines, bearing and range are displayed. For how to cancel the route see section section 5.11.3. If an autopilot is connected, the ship turns after passing the final destination and continues to sail around the final destination.

Note: The rudder may be suddenly turned depending on the make of autopilot and vessel speed.

To cancel route navigation after reaching the final destination, select [Stop Navigation].

3. Tap the close button on the title bar to finish.

5.11.11 Steering a route with the NAVpilot

When you select a point to follow and the NAVpilot-700 series is engaged and activated (see subsection 2.13.1) in the system, the message "DO YOU WANT TO NAVIGATE USING THE NAVPILOT?" appears. Tap [Yes] to have the NAVpilot steer the vessel, then the NAVpilot automatically goes into the NAV mode. For the NAVpilot-300, you are asked to select a navigation mode. Select [Precision] or [Economy]. ([Cancel] stops the NAV mode.) After selecting a mode, the NAVpilot-300 automatically goes into the NAV mode.

Precision mode: Keeps XTE within 0.01 NM

Economy mode: Keeps XTE within 0.03 NM

Note: The example figure below shows the NAVpilot's display in the NAV mode. See section 2.13.3 for details.

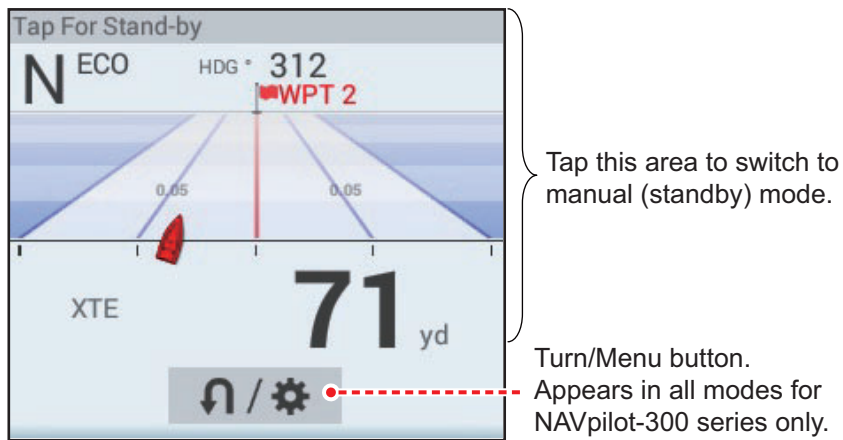

5.12 SAR Operations

The SAR (Search And Rescue) feature facilitates search and rescue, and MOB (Man Over Board) operations. This feature requires several installation menu changes and requires a qualified technician to make the necessary menu changes. To active this feature, contact your local dealer.

1. On the chart plotter display, tap the location where you want to start SAR operations.
2. On the pop-up menu, tap [New SAR Pattern].

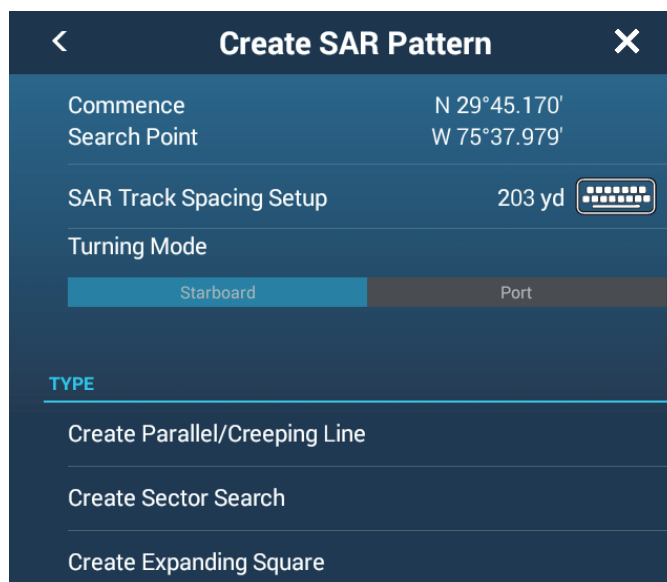

3. **Enter coordinates.** Tap [Commence Search Point] to show the software keyboard. Input the coordinates for the starting location, then tap [✓].
4. **Enter the length of the interval.** Tap [SAR Track Spacing Setup] to show the software keyboard. Set the distance between the SAR tracks, then tap [✓].
5. Tap [Starboard] or [Port] to select the direction in which to start the SAR pattern.
6. Tap the type of pattern you want to use. The following figures show examples for each of the patterns.

Type	Sample Pattern
<p>Parallel/Creeping Line</p>	
<p>Sector Search</p>	
<p>Expanding Square</p>	

The screen shows the SAR and the SAR area, a dashed rectangle.

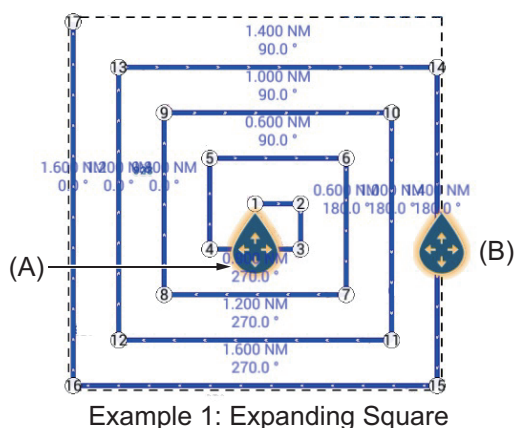
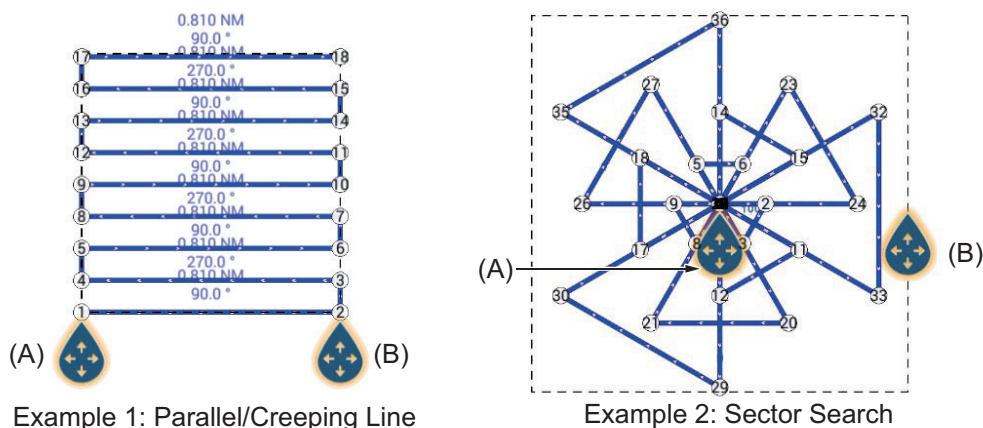

7. To change the search commence point, drag the icon marked as (A) in the figure above.
8. If necessary, change the bearing search area by dragging the icon marked as (B) in the figure above.
9. Tap [End SAR] to finalize the SAR area.
10. Tap [OK] to start SAR operations.
If the NAVpilot-700 series is engaged and activated (see subsection 2.13.1) in the system, the message "DO YOU WANT TO NAVIGATE USING THE NAVPILOT?" appears. Tap [Yes] to have the NAVpilot steer the vessel, then the NAVpilot automatically goes into the NAV mode. For the NAVpilot-300, you are asked to select a navigation mode.
11. Select [Precision] or [Economy]. ([Cancel] stops the NAV mode.)
Precision: Keeps XTE within 0.01 NM
Economy: Keeps XTE within 0.03 NM

5.13 Fuel Level Indicators

This equipment provides indicators that show both the approximate location where you may run out of fuel and the distance you can travel with the remaining fuel. This function requires the NMEA 2000 sentence PGN127489 (Engine Fuel Rate).

Fuel max range indicator (on route)

The fuel pump icon marks on the current route how far you can travel on the remaining fuel. To show this marker, tap [Settings]→[Routes]→[Fuel Max Range]→[ON].

Fuel range indicator (ring about own position)

The fuel range indicator draws a circle about own ship, the radius of the circle equivalent to the distance you can travel with the remaining fuel. To show this indicator, tap [Settings]→[Ship & Track]→[Fuel Range Ring]→[ON].

5.14 Laylines

A layline is the best course for route, calculated using wind speed and direction^{*1}, heading^{*1}, own ship speed^{*1} and tidal currents^{*2}.

^{*1} Appropriate sensors for these data are required to use the layline feature.

^{*2} Item set at section 5.14.1.

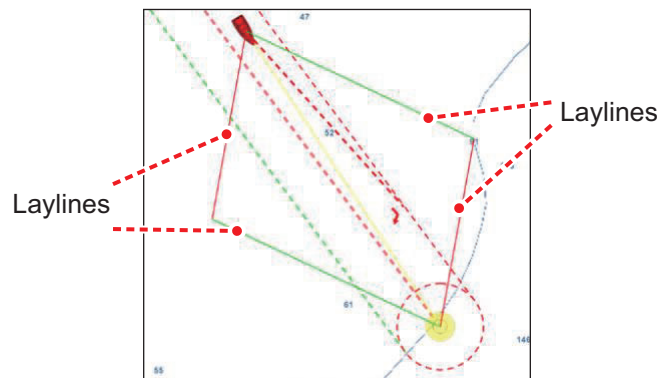

5.14.1 How to enable/disable the layline feature

Go to the Home screen, then tap [Settings]→[Routes]. Turn [Laylines] on or off as required.

If you want to show tidal offsets on laylines, turn on [Tidal Offset for Laylines] in the [Routes] menu.

5.14.2 How to show layline data in the data area

1. Open the data area, then tap [DATA] (at the bottom of the data area).
2. Tap the location in the data area where you want to show the layline data, and the [Add NavData] menu appears.

3. Tap [Layline Information]. Data for port-side and starboard-side appears in the data area.

Laylines Information	
Port	
Optimum Cap	344.4 °
Distance	16.86 km
Time to go	1h34'
Starboard	
Optimum Cap	277.4 °
Distance	17.18 km
Time to go	1h39'

5.14.3 How to change the polar wind file

Your NavNet TZtouch3 comes with a pre-installed polar wind file. This file contains data for sailboats, helping to improve sailing performance, by applying the data to the laylines. Polar files can be downloaded from the MyTimeZero™ cloud service and imported to the NavNet TZtouch3.

1. From a your PC (internet connection required), access the following site (without quotation marks) "<https://furuno.mytimezero.com/#!/tzt2/polars>".
2. Login to your MyTimeZero™ account.

The screenshot shows the MyTimeZero web interface. At the top, there's a header with the TZ logo and 'Hello, Toshi Horii' with a 'Log Out' link. The main content area is divided into four numbered steps:

- 1 DOWNLOAD**: Select your shipyard, and download the polar file from the links below.
- 2 COPY ON USB FLASH DRIVE**: Copy the downloaded .xml file on a USB flash drive. Your polar file must be at the root of the USB drive.
- 3 IMPORT THE FILE**: Insert the flash drive in your TZtouch2 MFD (TZTL12F/15F, TZT2BB). Select "Import Wind Polar" in the Files menu, select your file and press OK.
- 4 YOU'RE DONE**: TZtouch2 MFD will from now on use your wind polar for Laylines calculations.

Below the steps, there is a dropdown menu for 'Select your shipyard' set to 'All shipyards'. Below that is a table of available files:

File	Shipyard	Date	Size	Download
60 ft mono	Others	2018/02/26 23:53:01	212 KB	
60 ft Multi	Others	2012/10/05 20:30:28	12 KB	

3. Download the required polar file and save the file to a USB flash memory.
Note: MicroSD card cannot be used.
4. Connect the USB flash memory to the TZtouch3 USB cable.
5. On the TZtouch3, Go to the Home screen, then tap [Settings]→[Files]. The Files menu appears.
6. Tap [Import Wind Polar]. The list of available polar wind files appears.
7. Tap the file you want to import, then tap [OK].
8. Check that the select file's name appears in the menu, directly below [Import Wind Polar].
9. Tap the close button on the title bar to finish.

5.15 Routes Menu

This section provides descriptions for the items in the [Routes] menu not previously mentioned.

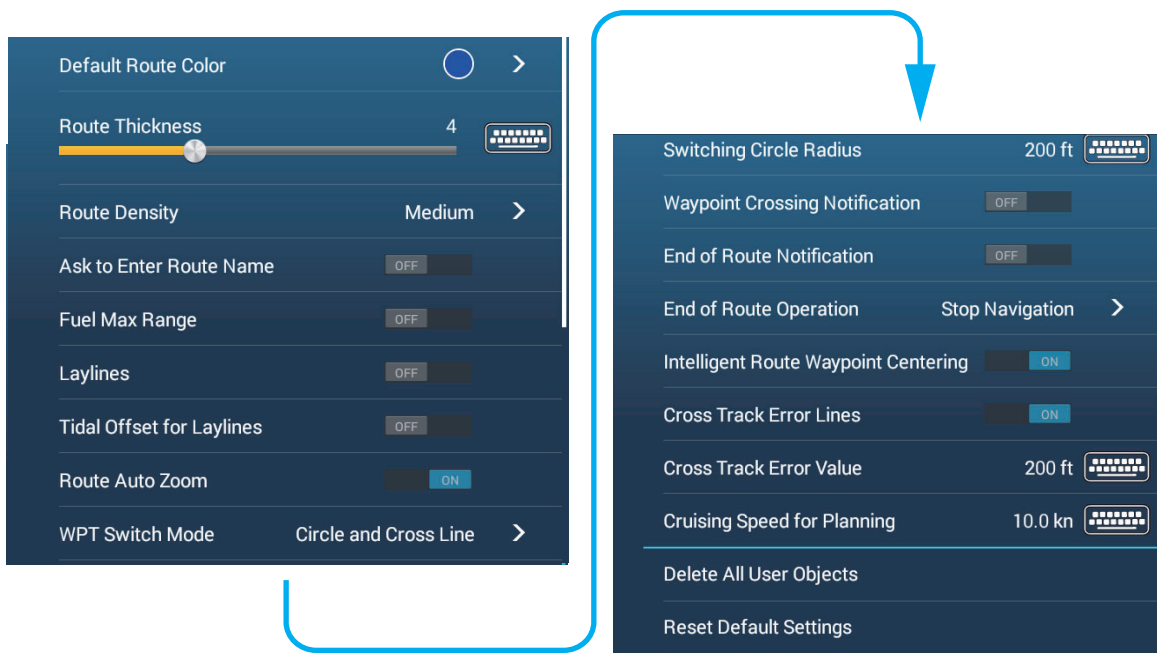

[Default Route Color]: Select the color of the routes. The options are red, blue, green, yellow, magenta, orange, cyan, or black & white.

[Route Thickness]: Select the thickness of the routes.

[Route Density]: Select the quantity of routes to show on the chart plotter display.

[Ask to Enter Route Name]: Show the software keyboard to enter route name after you create a route. The default setting is "ON".

[Intelligent Route Waypoint Centering]: When you create a route, center a route point each time it is selected on the screen.

[Cruising Speed for Planning]: Set the default cruising speed for routes (see section 5.4).

[Reset Default Settings]: Select this menu item to restore default settings for the [Routes] menu.

6. RADAR

This chapter provides the information necessary for radar operation, which requires a radar sensor.

Radar-related settings can be accessed in the two ways shown below. In this manual, this operation is written as “Open the [Radar] menu.”

- From the Home screen, tap [Settings]→[Radar].
- From the Layers menu, tap [Radar Settings].

Note: To change the radar source, go to the Home screen, tap [Settings] and [Radar], select [Radar Source], then tap desired radar source. This can also be done from the Layers menu.

6.1 How to Transmit, Set the Radar in Stand-by

Tap the [TX] icon at the bottom right corner of the screen to put the radar in transmit or stand-by state. The icon is filled in white when the radar is in transmit state. (Transmit, stand-by can also be controlled from the pop-up menu with [TX/STBY].)

If you do not require the radar for some time, set the radar in stand-by to save the magnetron from unnecessary use.

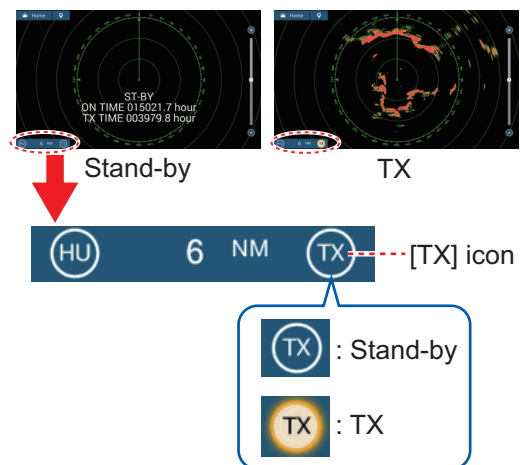

TX channel selection (w/DRS-NXT series radar sensor)

In the default setting, the best TX channel is automatically selected at random among three channels. However, if interference is received from the radar of a nearby ship, open the [Radar] menu, then set [TX Channel] to [1], [2] or [3], the channel where the interference is smallest.

6.2 Tuning

By design the radar receiver is tuned automatically after the radar is set to transmit. If you require fine tuning, do the following to tune manually:

1. Open the Home screen, then tap [Settings]→[Radar].
2. The default tuning method is automatic. Turn off [Auto Tuning] to enable manual tuning.
3. Drag the slider at [Manual Tuning] to set the value.
4. Tap the close button on the title bar to finish.

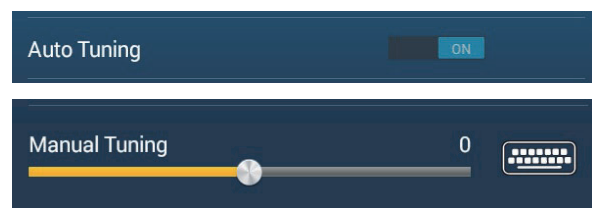

6.3 How to Adjust the Gain

You can adjust the gain (sensitivity) of the radar receiver. The correct setting shows some background noise on the screen. If you do not use enough gain, weak echoes are erased. If you use more gain than necessary, the background noise hides both weak and strong targets.

The gain can be adjusted from the pop-up menu, slider bar (two finger tap function), and data area).

Method 1: Pop-up menu

Automatic adjustment:

1. Tap the radar display to show the pop-up menu then tap [Radar Adjust].
2. Turn [Auto Gain] on.

Manual adjustment:

1. Tap the radar display to show the pop-up menu then tap [Radar Adjust].
2. Turn [Auto Gain] off.
3. Tap [Manual Gain].
4. Use the slider bar to adjust the gain: Drag the knob, drag the gain indication box, or tap the "+" or "-" symbol.
5. Tap [Done] at the top of the screen to finish.

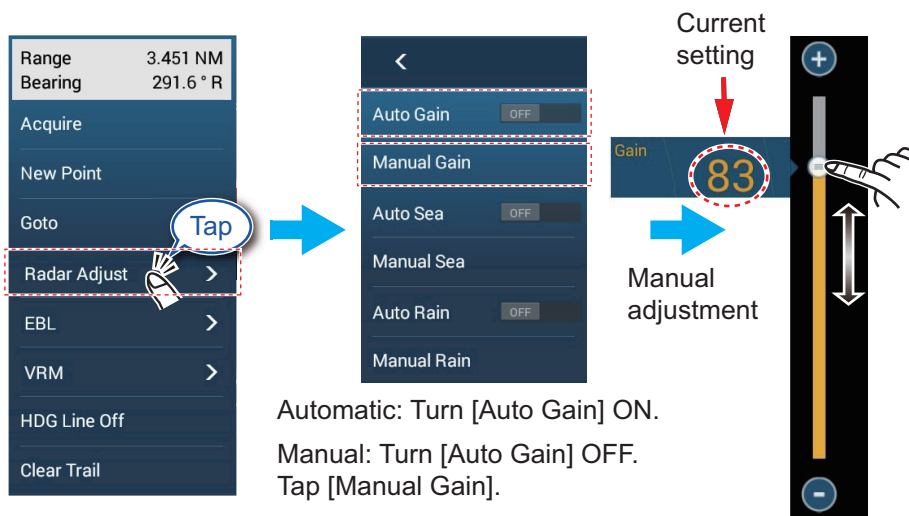

Method 2: Two finger tap

Note 1: Set [Two Finger Tap Function] (or [Two Finger Long Tap Function]) to [Gain Control] in the [General] menu to enable on-screen gain adjustment. See section 1.16.

Note 2: To enable manual gain adjustment, tap the radar screen to show the pop-up menu. Tap [Radar Adjust], then set [Auto Gain] to [OFF].

Tap (long tap) the screen with two fingers to show the Gain slider bar. Adjust the slider bar referring to the illustration above.

Method 3: Radar Control data box in data area

The gain can be adjusted from the data area, with the [Radar Control] box in the [RADAR] data box.

1. Tap [RADAR] at the bottom of the data area.
2. Tap the [M/A] flipswitch of [Gain].
[M] means manual; [A] means Automatic. Tap the flipswitch to switch between automatic and manual gain adjustment. For manual adjustment go the step 3.
3. Tap the numeric indication of [Gain].
4. Use the slider bar to adjust the gain: Drag the knob, drag the gain indication box, or tap the "+" or "-" symbol.
5. Tap [Done] at the top of the screen to finish.

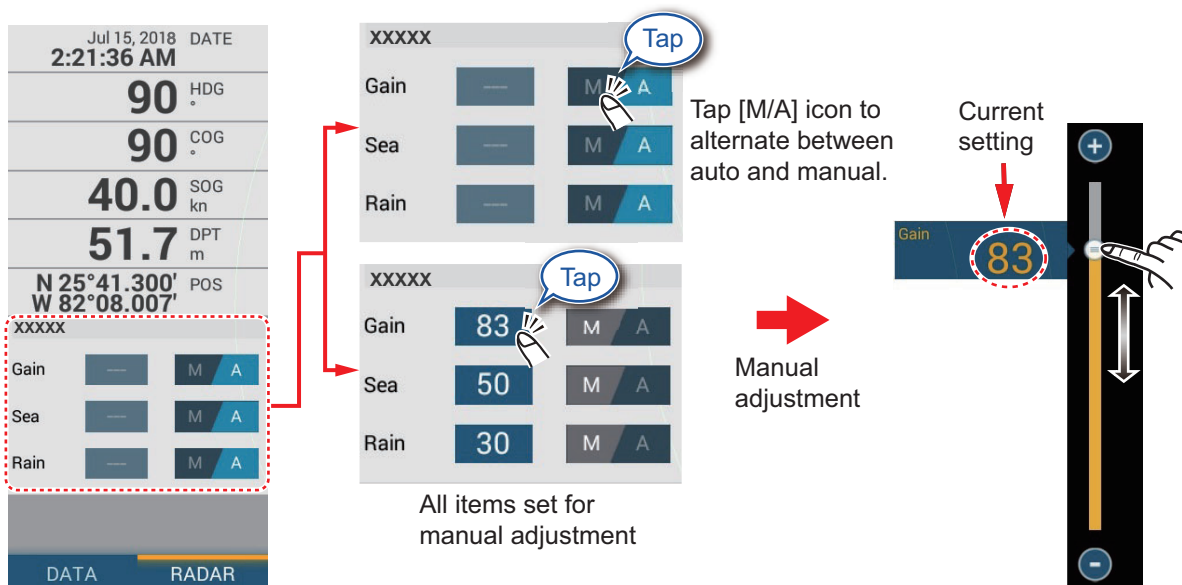

6.4 How to Reduce the Sea Clutter

The reflected echoes from waves appear at the central part of the screen and have the name "sea clutter". The sea clutter increases in width as the height of waves and the height of the antenna above the water increase. If the sea clutter is strong, targets can be hidden inside the clutter, like in the right-hand figure.

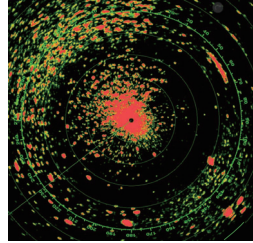

Sea clutter visible at the screen center

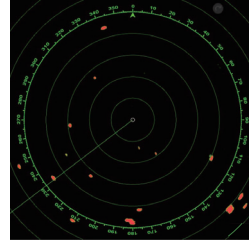

Sea control adjusted; clutter suppressed

When the sea clutter hides targets, adjust the sea control (automatically or manually) to reduce the clutter. Like with gain, sea clutter can be adjusted from the pop-up menu, slider bar, data area. See the procedures in section 6.3.

For automatic sea clutter suppression, there are two methods: [Advanced] and [Coastal]. [Advanced] provides good overall clutter reduction, however some surface reflections may appear on-screen. [Coastal] provides strong clutter reduction based on echo strength, however some objects, such as small land masses, may also be removed.

[Advanced] should be used under normal circumstances and [Coastal] should be used when reflections and clutter are not sufficiently removed under [Advanced].

To select an automatic sea clutter suppression method, open the Layers menu, tap [Advanced] or [Coastal] at [Auto Sea Mode].

6.5 How to Reduce the Rain Clutter

When your ship is in or near rain or snow, the reflections from rain or snow appear on the screen. These reflections have the name "rain clutter". When the rain clutter is strong, targets in or near the rain clutter are hidden in the clutter. Reflections from the rain clutter are easily identified from true targets by their wool-like appearance.

The rain control breaks the continuous display of rain or snow reflections into a random pattern. The rain control also helps to reduce the target clutter in good weather in busy harbors. When the rain clutter hides targets, adjust the rain control (automatic or manual) to reduce the clutter.

Like with gain, rain clutter can be adjusted from the pop-up menu, Rain slider bar, and data area. See the procedures in section 6.3.

6.6 Range Scale

The range setting controls the size of the area (in nautical miles, kilometers or statute miles) that appears on your screen. The range appears at the bottom right-hand corner of the screen.

How to zoom in or out the range scale

The range scale can be selected two ways, as shown below. The slider bar can be shown or hidden with [Show Scale Slider] in the [Settings]→[Radar] menu.

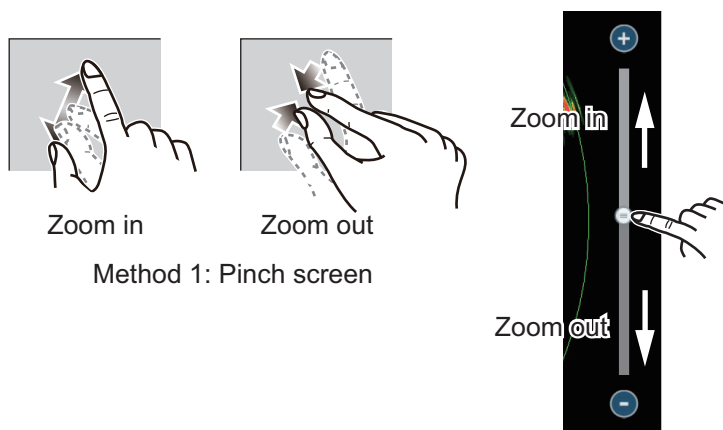

Method 1: Pinch screen

Method 2: Drag slider knob
(or tap bar or “+”, “-” symbols)

6.7 Orientation Mode

The orientation mode determines how you view the positional relationship between your ship and other targets and the state of movement. There are two orientation modes, head up and north up.

Head up: A display without azimuth stabilization in which the line that connects the center with the top of the screen indicates your heading. Targets are shown at their measured distances and in their directions relative to your heading.

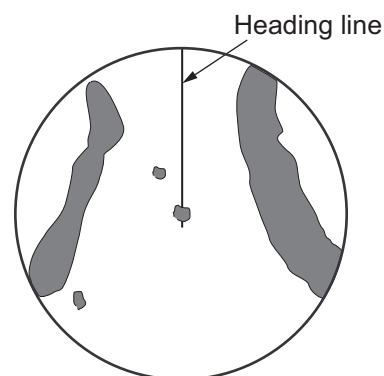

North up: Targets are shown at their measured distances and their true (compass) directions from your ship. North is at the top of the screen. The heading line changes its direction according to your heading.

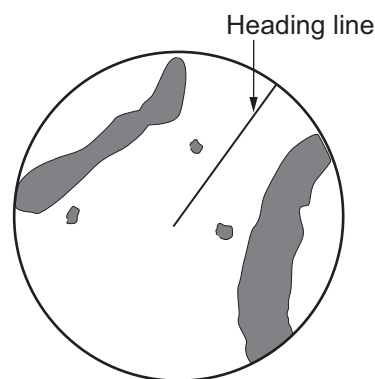

North up requires a heading signal. When the heading signal is lost, the radar automatically switches to the head up mode. To display the heading signal, reset the heading sensor. If necessary, reselect the display mode after the heading sensor is restored.

How to select an orientation mode

To select an orientation mode, tap the orientation mode icon [HU] (or [NU] whichever is shown) at the bottom right corner of the screen to show [HU] (Head-up) or [NU] (North-up).

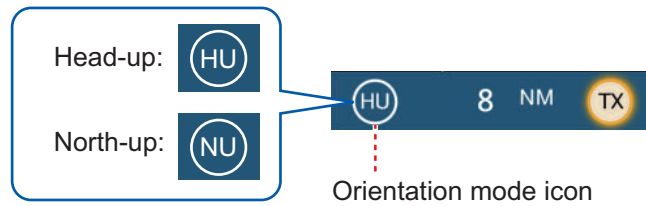

6.8 How to Measure the Range and Bearing from Your Ship to a Target

You can measure the range or bearing to a target by the following four methods.

	Range measurement	Bearing measurement
EBL (Electronic Bearing Line)	No	Yes
Fixed range rings	Yes	No
Ruler	Yes	Yes
Tap	Yes	Yes
VRM (Variable Range Marker)	Yes	No

6.8.1 How to display the range rings

The range rings are the concentric solid circles about your ship. Use the fixed range rings to get a rough estimate of the range to a target.

To show or hide the range rings, open the Layers menu, then turn [Radar Rings] on or off.

To measure the range with the range rings, count the number of rings between the center of the screen and the target. Check the range ring interval and estimate the distance of the echo from the inner edge of the nearest ring.

6.8.2 How to set the number of the range rings to show

1. Open the [Radar] menu.
2. Tap [Rings Interval].



3. Tap a number. [Automatic] automatically selects the number of rings according to the range scale.
4. Tap the close button on the title bar to finish.

6.8.3 How to select the range rings mode

To select the range rings mode, open the [Radar] menu, then set [Bearing Scale Mode] to [True] or [Relative].



6. RADAR

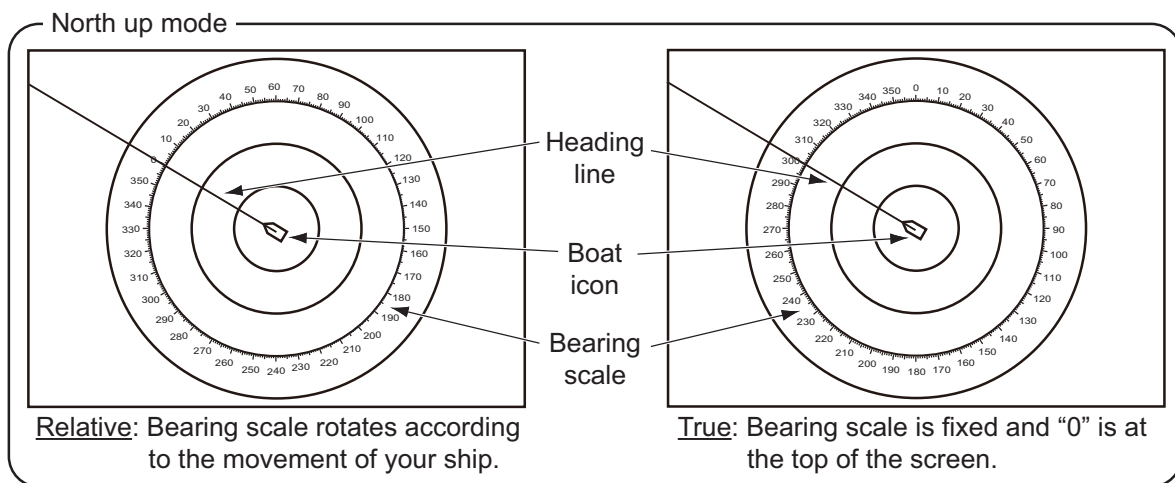
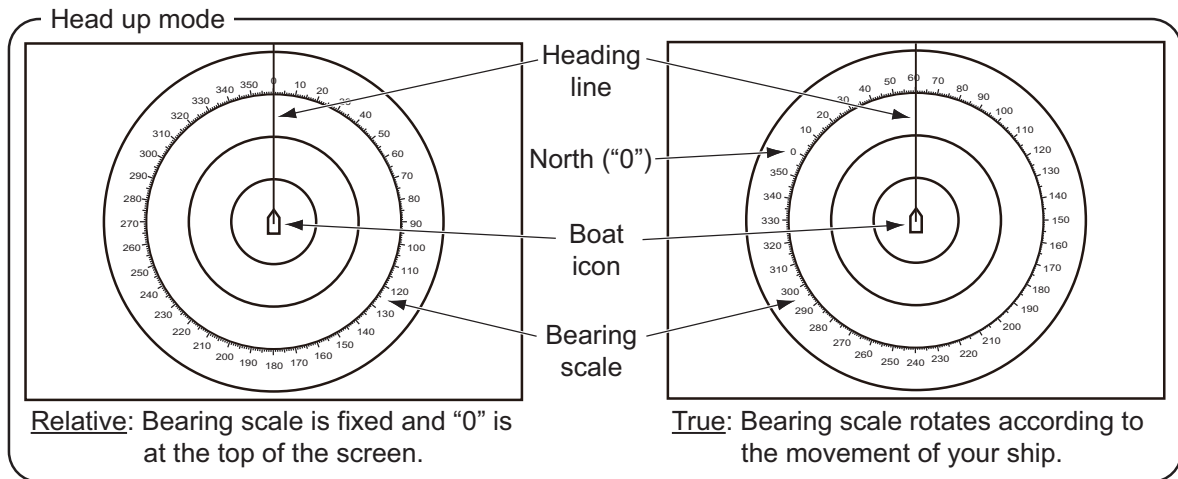

6.8.4 How to measure the range and bearing to an object

Tap an object to get its range and bearing from own ship. Read the range and bearing in the pop-up menu.

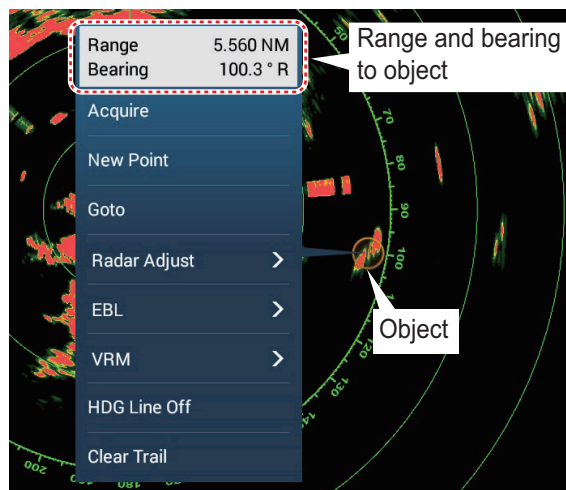

6.8.5 How to measure the range with the VRM

The VRM is a dashed ring so that you can identify the VRM from the fixed range rings.

Method 1: Using the EBL/VRM box in the data area

1. Referring to section 1.9.3, add the [EBL/VRM] data box to the [RADAR] data area.
2. Display the data area, then tap [RADAR].
3. Tap the VRM indication in the [EBL/VRM] data box.
4. Operate the VRM so that it rests on the inner edge of the target. Drag the VRM on the radar display, drag the slider bar, drag the VRM indication box, or tap the "+" or "-" symbol. The current VRM range is shown in the VRM indication box.
5. Tap [End VRM] at the top of screen to finish.
6. To clear the VRM, open the pop-up menu, then tap [VRM]→[Clear].

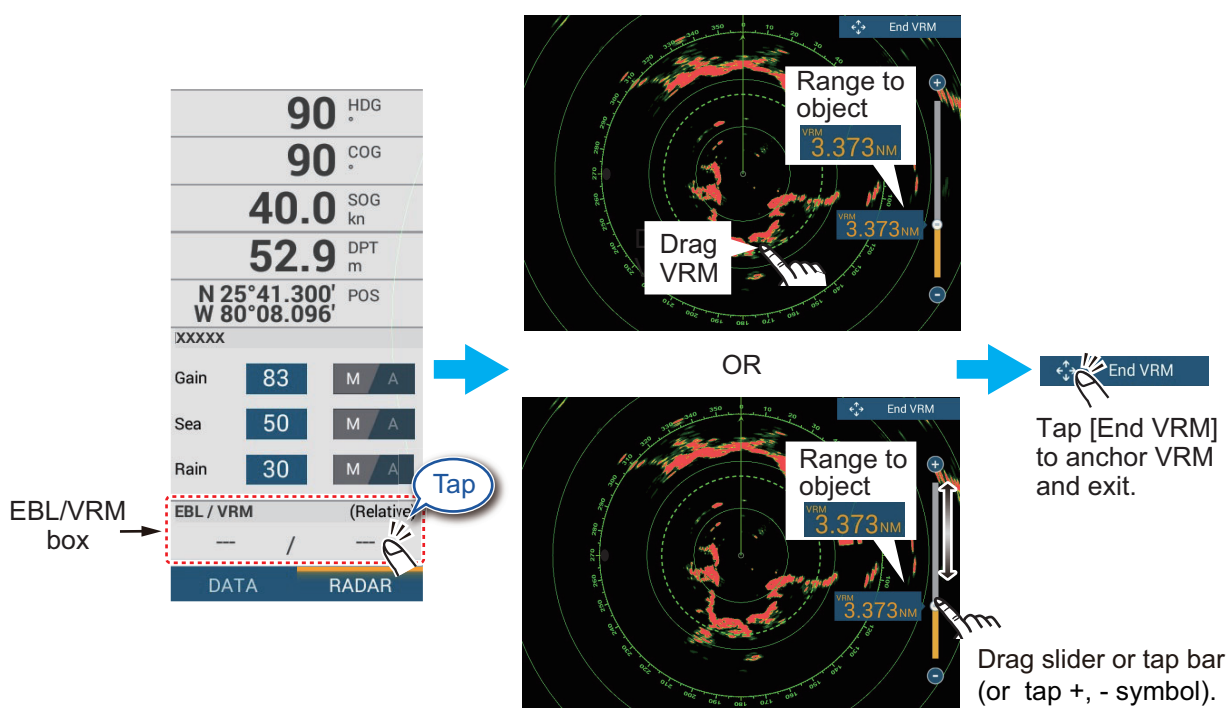

Method 2: Using the pop-up menu

1. Tap the radar display to show the pop-up menu, then tap [VRM]→[Adjust].
2. Operate the VRM rests on the inner edge of the target. Drag the VRM on the radar display, drag the knob on the slider, drag the VRM indication box, or tap the “+” or “-” symbol. The current VRM range is shown in the VRM indication box.
3. Tap [End VRM] at the top of screen to finish.
4. To clear the VRM, open the pop-up menu, then tap [VRM]→[Clear].

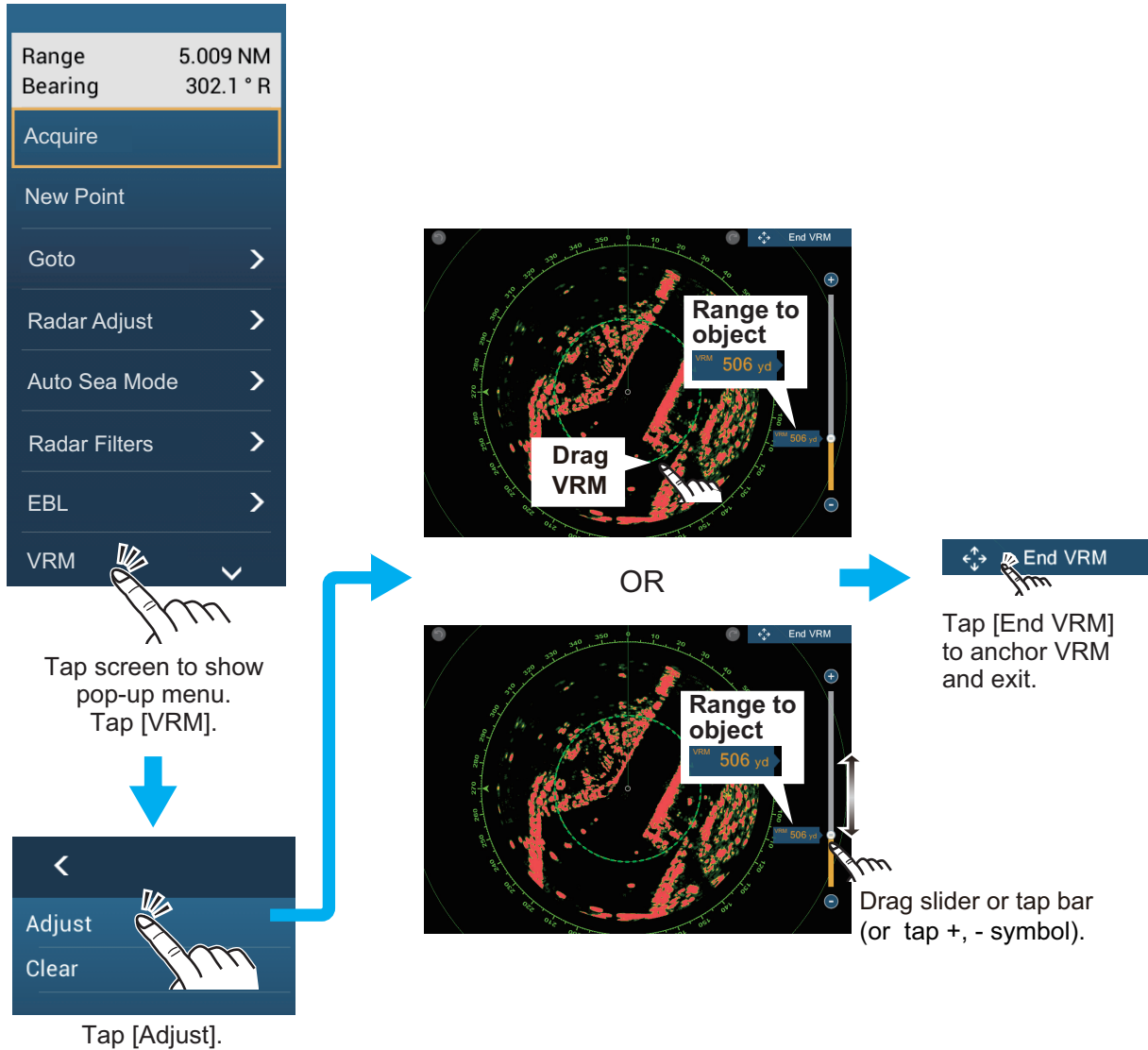

6.8.6 How to measure the bearing with the EBL

Method 1: Using the EBL/VRM box in the data area

1. Referring to section 1.9.3, add the [EBL/VRM] data box to the [RADAR] data area.
2. Display the data area, then tap [RADAR].
3. Tap the EBL indication in the [EBL/VRM] data box.
4. Operate the EBL so that it passes through the center of the target. Drag the EBL on the radar display, drag the knob on the slider, drag the EBL indication box, or tap the "+" or "-" symbol. The current EBL bearing is shown in the EBL indication box.
5. Tap [End EBL] at the top of screen to finish.
6. To clear the EBL, open the pop-up menu, then tap [EBL]→[Clear].

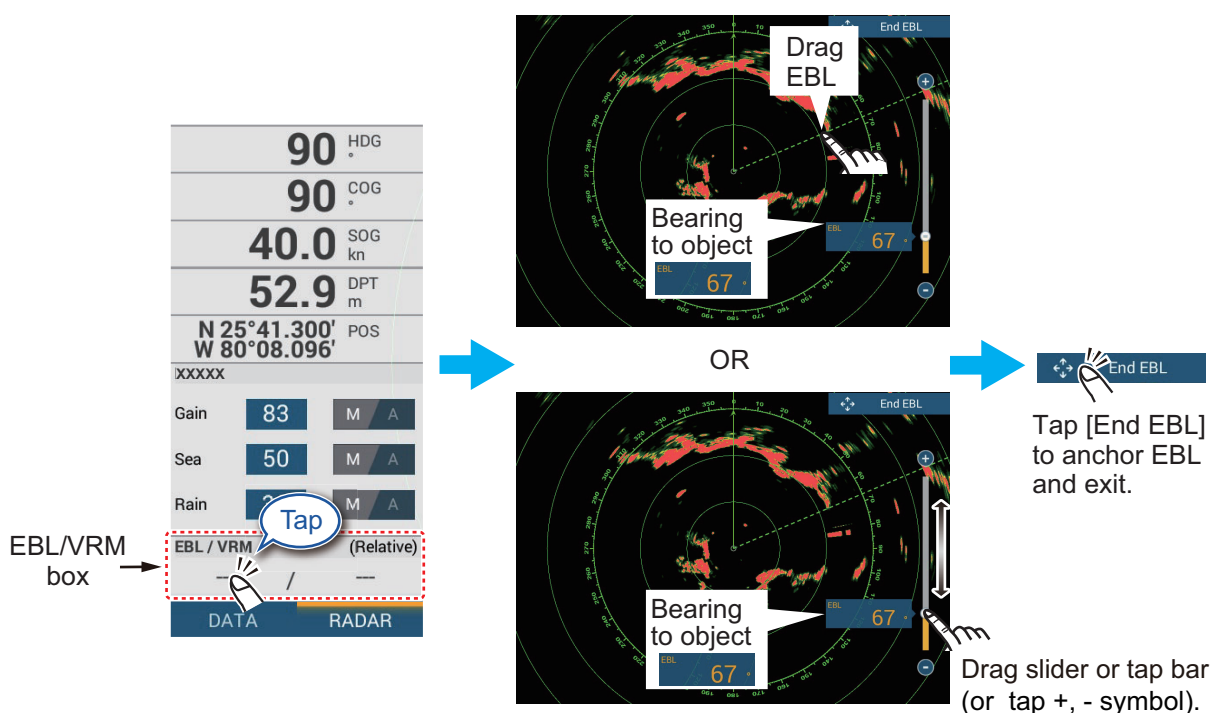

Method 2: Using the pop-up menu

1. Tap the radar display to show the pop-up menu, then tap [EBL]→[Adjust].
2. Operate the EBL so that it passes through the center of the target. Drag the EBL on the radar display, drag the knob on the slider, drag the EBL indication box, or tap the “+” or “-” symbol. The current EBL bearing is shown in the EBL indication box.
3. Tap [End EBL] at the top of screen to finish.
4. To clear the EBL, open the pop-up menu, then tap [EBL]→[Clear].

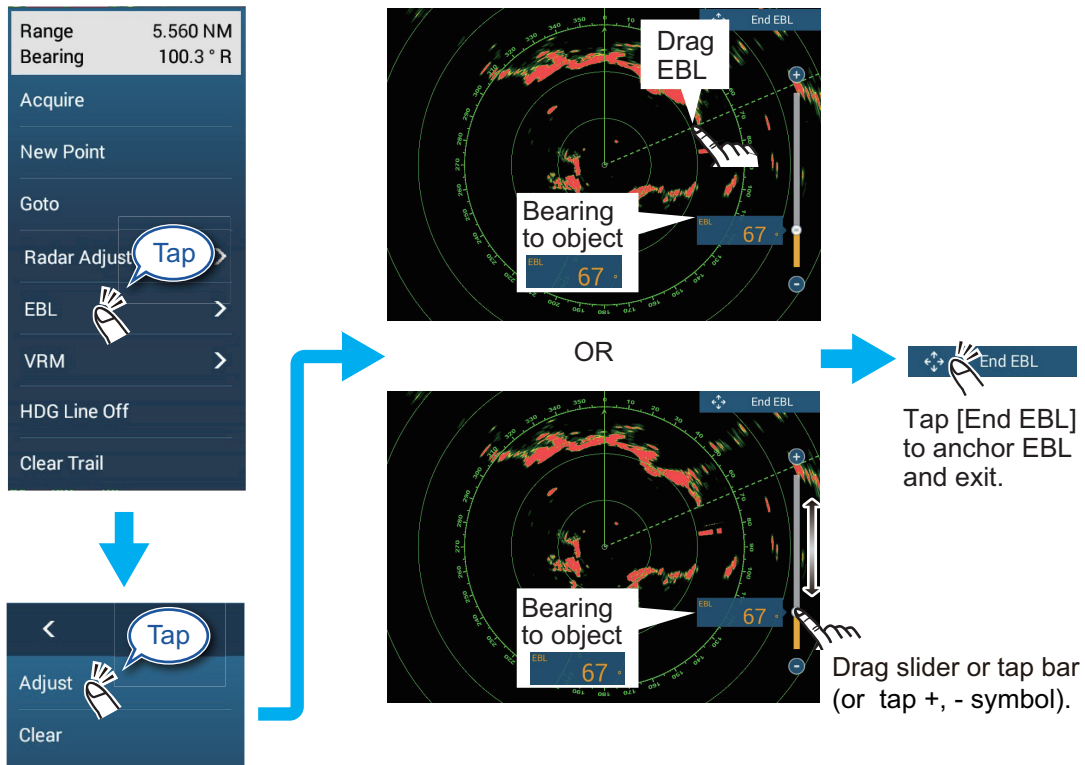
**6.8.7 How to select the EBL reference**

You can select the EBL reference from [True] or [Relative]. [True] means the bearing is in reference to the north. [Relative] means the bearing is relative to the heading of your ship. True bearing requires a heading sensor.

1. Open the Home screen, then tap [Settings]→[Radar].
2. Tap [EBL Reference].
3. Tap [True] or [Relative].
4. Tap the close button on the title bar to finish.

6.9 How to Measure the Range and Bearing Between Two Targets

You can measure the range and bearing between any two targets with the “ruler” feature, which you can access from the Slide-out menu.

1. Open the Slide-out menu then tap [Distance] to display the ruler, which has two drag-able circles connected with a line.

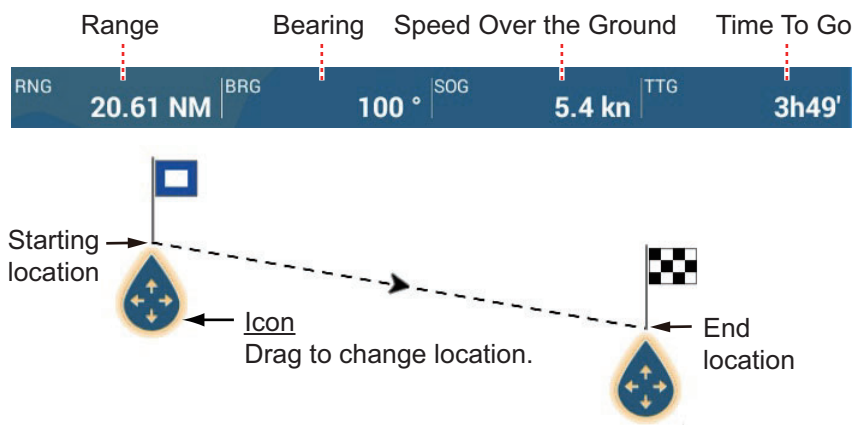

2. Drag the circles to set them on the objects for the measurement. The range and bearing between the objects, SOG and TTG appear at the top of the screen.
3. Tap [Cancel Ruler] at the top right-hand corner of the screen to erase the ruler and the indications.

6.10 How to Off-center the Picture

You can off-center your position to expand the view field without selecting a larger range scale. The position can be off-centered in the bow, stern, port or starboard direction, but not more than 75% of the range in use.

Pan the radar display by dragging with a finger. To return your ship to the center of the screen, tap [Center Radar] at the top right-hand corner of the screen.

Appears when ship is not at the center of the screen.

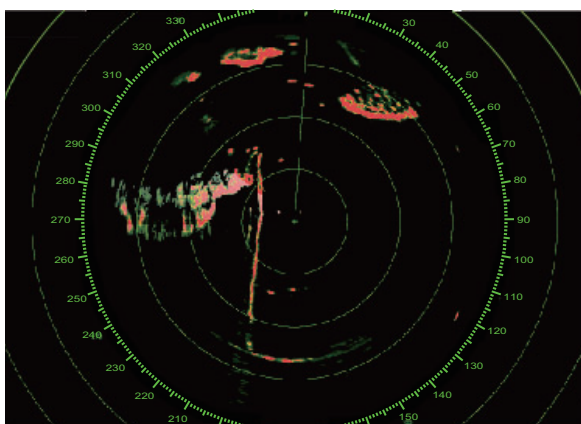

Normal picture

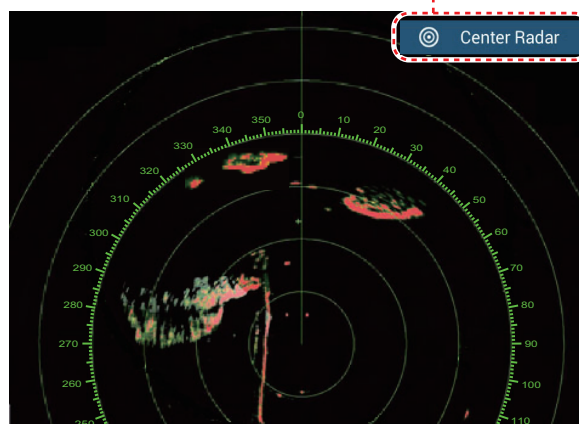

Picture off-centered in stern direction

6.11 Heading Line

The heading line indicates your heading in all orientation modes. This line connects between your position to the outer edge of the radar display. The line is at zero degrees on the bearing scale in the head-up mode. The orientation of the line changes in the north-up mode with the movement of your ship. If it is hard to identify the echoes on the heading line, you can hide the heading line and range rings for a few seconds. Open the pop-up menu, then tap [HDG Line Off] to hide the heading line and range rings. The heading line and the range rings reappear after approx. 5-6 seconds.

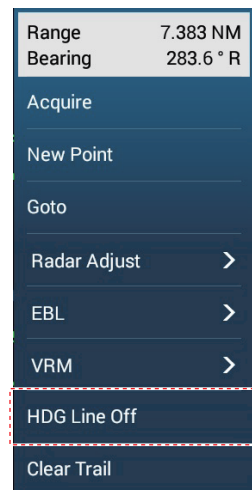

6.12 How to Reduce Radar Interference

Radar interference can occur when your ship is near the radar of another ship that operates on the same frequency band with your radar. The interference shows on the screen in many bright dots. The dots can be random or in the shape of dotted lines that run from the center to the edge of the screen. You can identify the interference from the normal echoes, because the interference does not appear in the same location at the next rotation of the antenna.

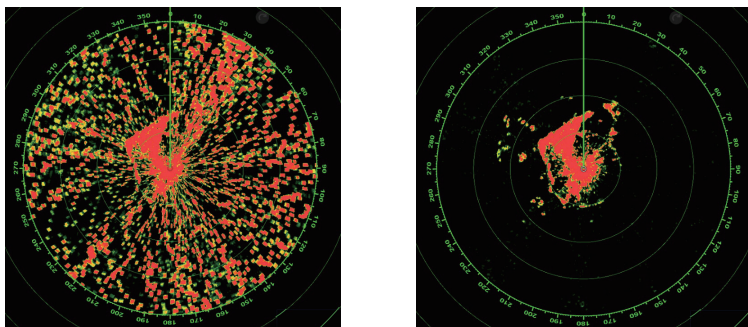

Turn off the interference rejector when there is no interference to prevent the loss of weak targets.

To use the interference rejector, Open the Layers menu, then turn [Interference Rejection] on or off.

6.13 Echo Average

The sea clutter reduction circuit can remove wanted echoes. If this occurs, use the echo average feature. Echo average reduces the brilliance of targets within sea clutter to allow you to better discriminate targets from sea clutter.

Note 1: Echo average requires heading and position data.

Note 2: Do not use echo average during heavy pitching and rolling, to prevent loss of targets.

Note 3: Before using echo average, properly adjust the sea clutter.

Note 4: In the dual radar display, echo average works only on the left half screen.

To turn the echo average feature on or off, open the Layers menu, then turn [Echo Averaging] off or on as required.

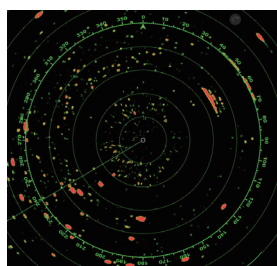

Echo Average OFF

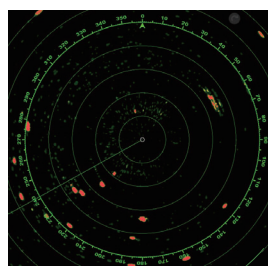

Echo Average ON

6.14 Guard Zone

The guard zone provides aural and visual alarms against targets (ships, islands, land-masses, etc.) that enter the area you set.

6.14.1 How to set a guard zone

Note: You can not set the guard zone with a remote control unit (MCU-002, MCU-004 or MCU-005). Use the touch operation to set the guard zone. The available range changes with the radar sensor.

DRS4D-NXT: 0-24 NM

X-class radar sensors: 0-16 NM

1. Open the Layers menu.
2. Turn on [Guard Zone 1] or [Guard Zone 2].
A dotted white line guard zone appears.
3. Tap on a line of the guard zone, and the pop-up menu appears.

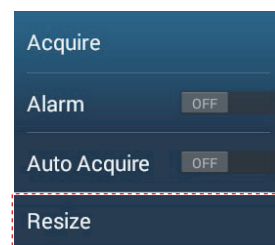

4. Tap [Resize]. Drag icons appear at the corners of the guard zone.

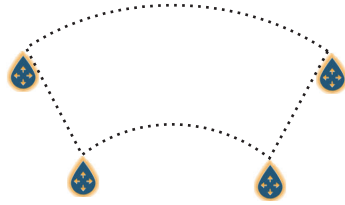

5. Drag the icons to adjust the guard zone.
Note: To create a 360 degree zone about own ship, set all four drag icons in the same direction.
6. Tap [Done] at to finish. The icons disappear.

How to set a guard zone with TZT9F/12F, remote controller (MCU-002/004/005)

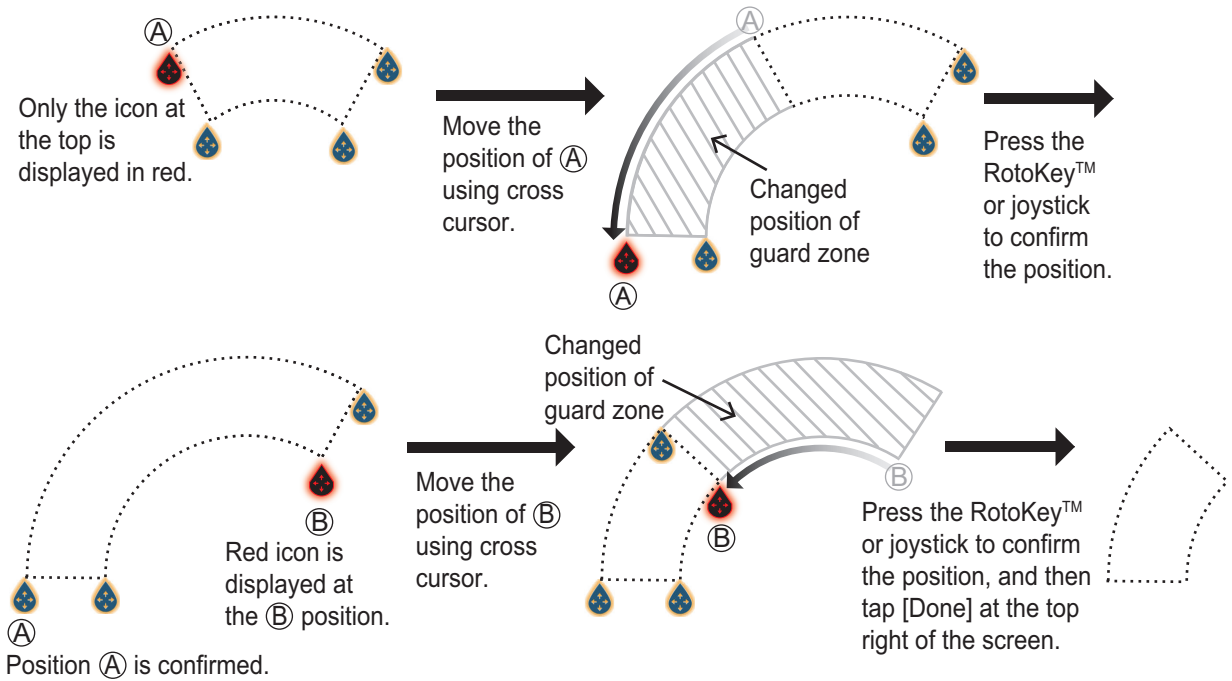

6.14.2 How to activate or deactivate a guard zone

1. Tap on a line of the guard zone to show the pop-up menu.
2. Turn [Alarm] on or off. The alarm is active when the guard zone lines are solid and the lines are dashed when the alarm is deactivated.

When a target (including target with echo trail) enters an active zone, the aural alarm sounds (if active), the target flashes, and the message "TARGET ALARM" flashes in the status bar. Tap the status bar to silence the aural alarm and stop the flashing message. The message remains in the status bar and the target continues to flash until the target leaves the guard zone or the alarm is deactivated.

You can mute the audio alarm by turning off [Alarm Sound] in the [Settings]→[Alarm] menu. (see subsection 2.10.8).

6.14.3 How to hide a guard zone

Open the Layers menu and turn [Guard Zone 1] or [Guard Zone 2] off. The guard zone is erased from the screen.

6.15 Watchman

The watchman feature transmits the radar for one minute at a specified time interval (5, 10 or 20 minutes) to monitor the guard zone. If a target is found in the guard zone, the watchman is canceled and the radar continues to transmit. This feature helps you watch for targets in the area you set when you do not continuously require the radar.

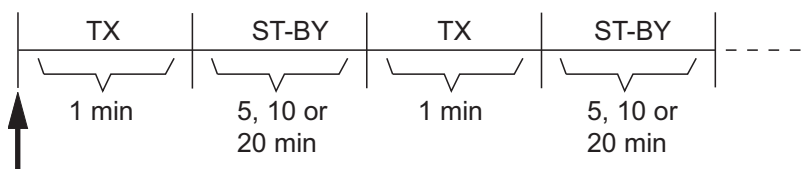

Watchman starts

1. Set a guard zone. See section 6.14. (Watchman does not operate unless a guard zone is active. Set Watchman when the radar is in transmit state.)
2. Open the [Radar] menu.
3. Tap [Watchman].

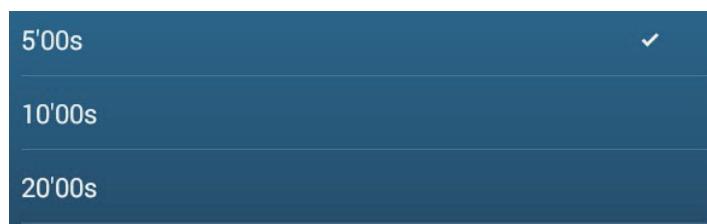

4. Tap a watchman rest interval.
5. Tap the close button on the title bar to finish.
6. On the radar display, tap the screen to show the pop-up menu. Turn [Watchman] on to activate the watchman function.

6.16 Echo Trail

Echo trails show the movements of radar targets relative or true to your ship in imitation afterglow, in a color different from the echo color. This function helps alert you to possible collision conditions.

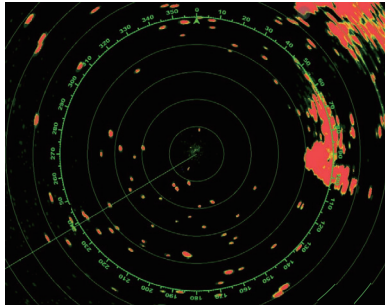

Trails on

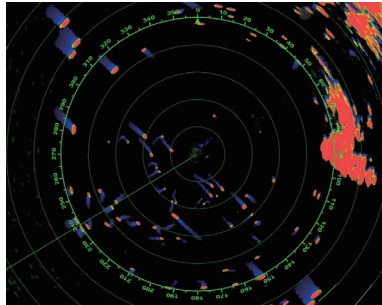

Trails off

Note: In the dual radar display, echo trail works only on the left side screen (shown as (1) in the figure to the right).

6.16.1 How to show, hide echo trails

Tap the screen to show the pop-up menu, then set [Echo Trail] to [OFF] or [ON] as required.

6.16.2 How to clear echo trails

Tap the screen to show the pop-up menu, then select [Clear Trail].

6.16.3 How to select echo trail length

1. Open the [Radar] menu.
2. Set [Trail Length].

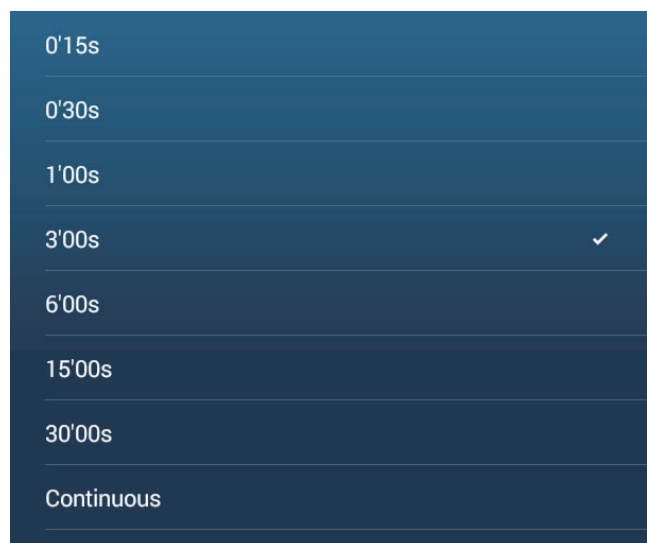

3. Tap desired length.
4. Tap the close button on the title bar to finish

6.16.4 How to select the echo trail mode (reference)

Trail movement can be set for relative or true. Trails require position and heading information.

Relative trails: Show the relative movements between targets and your ship.

True motion trails: Show the movements of targets according to the targets over-the-ground speeds and courses.

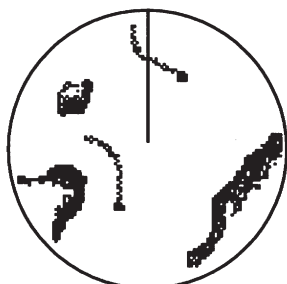

True echo trails
(No smearing of stationary targets)



Relative echo trails
(Targets moving relative to own ship)

1. Open the [Radar] menu.
2. Tap [Trail Mode]

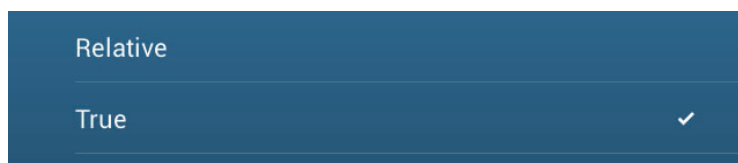

3. Tap [True] or [Relative] as required.
4. Tap the close button on the title bar to finish.

6.16.5 How to select echo trail color

1. Open the [Radar] menu.
2. Set [Trail Color].

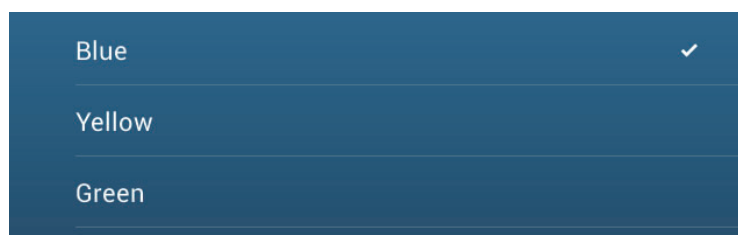

3. Tap desired color.
4. Tap the close button on the title bar to finish

6.16.6 How to select echo trail shading

The afterglow of the target trails can be shown in a single tone or gradual shading.

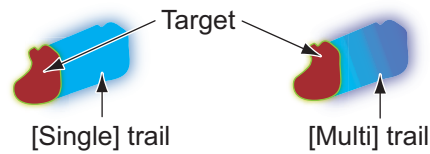

1. Open the [Radar] menu.
2. Set [Trail Shade].

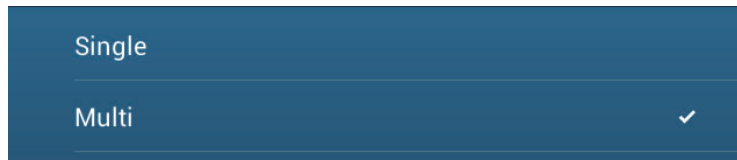

3. Select [Single] or [Multi] as appropriate.
4. Tap the close button on the title bar to finish.

6.17 How to Show, Hide or Cancel an Active Route

You can show, hide the active route on the radar display. Open the Layers menu then turn [Routes] on or off.

To cancel route navigation, tap any part of the route then tap [Stop Nav] on the pop-up menu.

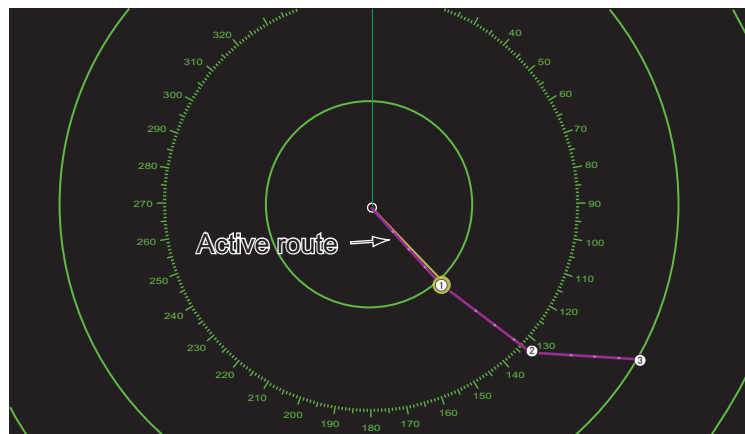

6.18 How to Show or Hide the Own Ship Icon

You can show or hide the own ship icon on the radar display.

1. Open the [Radar] menu.
2. Turn [Own Ship Icon] on or off.
3. Tap the close button on the title bar to finish.

6.19 Echo Color

Echo color is available in colors of green, yellow or multicolor. [Multicolor] displays echoes in colors of red, yellow and green, corresponding to signal levels of strong, medium and weak.

1. Open the [Radar] menu.
2. Tap [Echo Color].

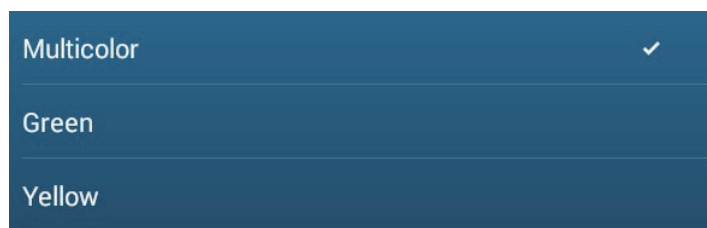

3. Tap desired color.
4. Tap the close button on the title bar to finish.

6.20 Background Color

You can select the background color for daytime and nighttime operations.

1. Open the [Radar] menu.
2. Tap [Day Background Color] or [Night Background Color] menu.

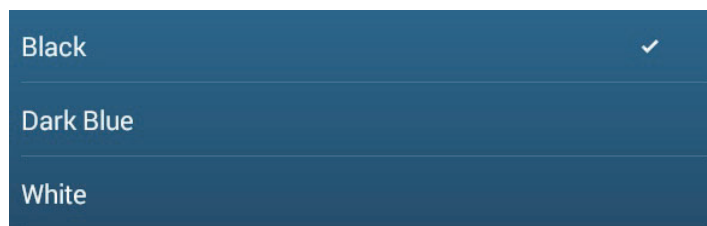

Day Background Color

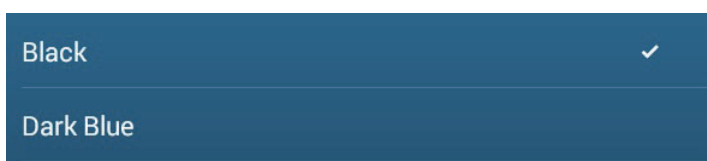

Night Background Color

3. Tap desired color.
4. Tap the close button on the title bar to finish.

6.21 Dual-Range Display

The dual-range display scans and displays two different radar ranges at the same time, with a single antenna. There is no time delay between the two pictures and, with the magnetron radar, you have separate control of each picture. (The solid state radar has some restrictions. See the table below for details.) This feature lets you keep a close watch on close-range targets and far targets.

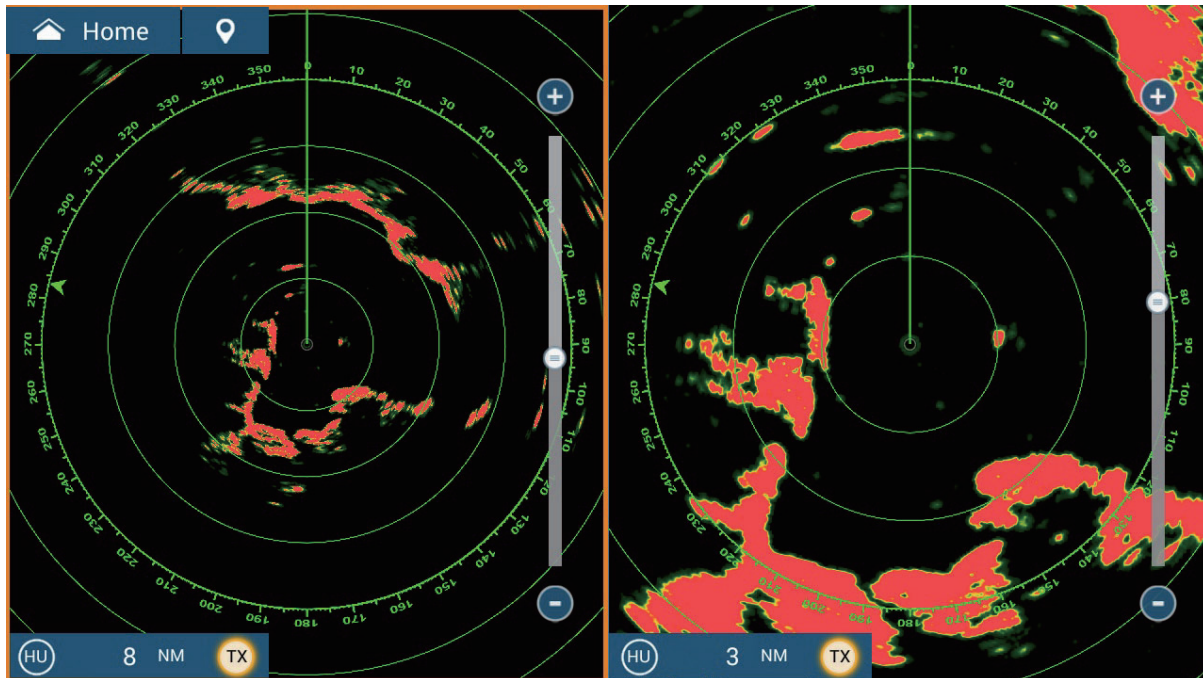

Long range display

Short range display

Note: Radar sensor DRS4DL/DRS4DL+ does not have the dual-range display.

To get the dual-range display, set dual-range displays on the Home screen. See subsection 1.7.1 for the procedure. You can put the dual-range displays in the two-way and three-way split screens.

Most radar functions can be adjusted independently. The table below shows radar function and operability in the dual range mode, for both the magnetron radar and the solid state radar. Note that, in the worst case, the maximum detection range may decrease by approx. 10 dB with the solid state radar.

- | | |
|---|----------------------------|
| • Active route (show, hide) | • Radar TX* |
| • Rain clutter suppression | • Gain adjustment |
| • Heading line, range rings (temporarily erase) | • Sea clutter removal |
| • Range change | • AIS/ARPA (show, hide) |
| • Operation mode (head-up or north-up) | • Range rings (show, hide) |
| • Auto sea mode ([Advanced] or [Coastal]) | • Bird mode |
| • Operation mode (head-up or north-up) | |

*1 This function is not available for DRS4D-NXT/DRS6A-NXT/DRS12A-NXT/DRS25A-NXT.

*2 The no.1 screen is independent of the no.2 screen when the no.2 screen is in stand-by. However, when the no.2 screen goes to transmit state, so does the no.1 screen.

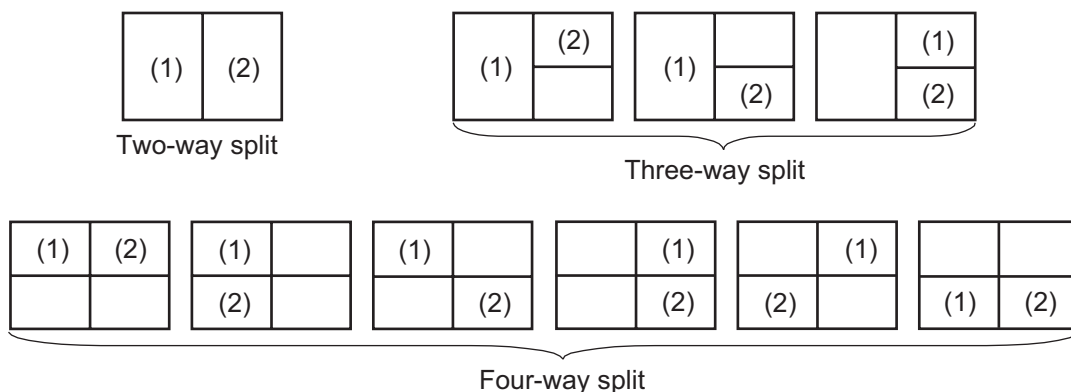

6.22 Bird Mode

The Bird mode sets up the radar for optimal detection of flocks of birds, which indicates the presence of schools of fish. Additionally, the bird mode can be used to detect distant rain clouds.

Gain, sea clutter and rain clutter are automatically adjusted according to the bird mode setting.

The use of echo trail and echo average functions together with the bird mode make it easier to distinguish bird echoes from other echoes. With echo average, echoes from birds are emphasized. With true echo trails, moving vessels show long, steady trails. Unlike those targets, bird echoes appear randomly and show random, short trails.

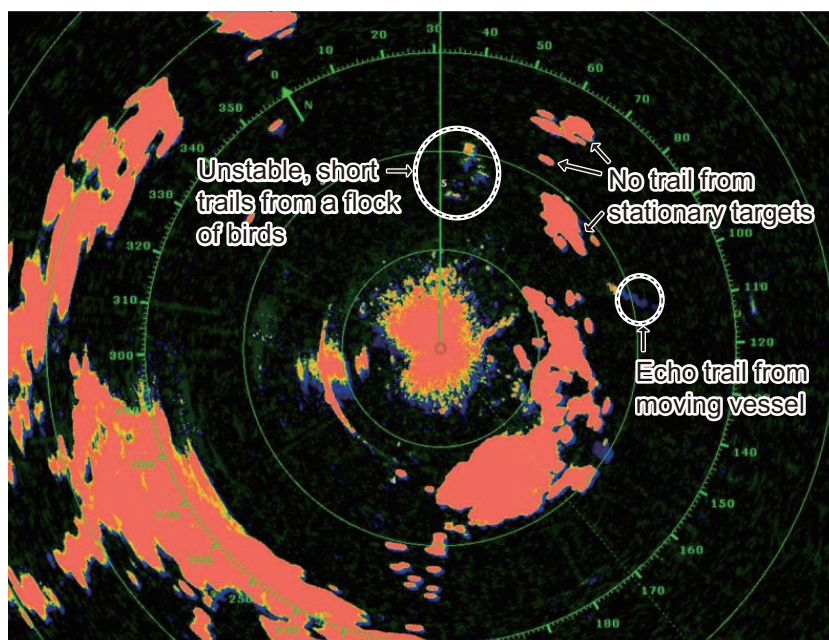

The bird mode has three settings. Select the option according to the severity of the sea clutter.

To select the bird mode setting, open the Layers menu, tap [Bird Mode], then select [Calm], [Moderate], or [Rough].

[Calm]: Suitable in calm conditions where sea clutter is weak. Applies low sea clutter reduction to show weak bird echoes. When sea clutter is strong, bird echoes may be hidden inside the sea clutter.

[Moderate]: Suitable where sea clutter is moderate. Applies medium sea clutter reduction.

[Rough]: Suitable in rough weather conditions where sea clutter is strong. Applies high sea clutter reduction. Weak bird echoes may be suppressed in this setting.

To turn off the bird mode, select [Off]. When the bird mode is active, the bird mode icon appears to the right of the TX/STBY switch, as shown below.



Usage precautions

- Do not use the Bird mode in rough weather.
- Do not use the Bird mode during a voyage. The Bird mode settings are not suitable in a voyage.
- ARPA performance may be reduced when the Bird mode is active.
- Radar Adjust (Gain, Sea, Rain) and Auto Sea Mode cannot be adjusted when the Bird mode is active.
- Schools of fish that attract birds tend to dive suddenly, which may result in unstable or disappearing echoes.

6.23 Target Analyzer™

The Target Analyzer™ analyzes echoes and displays targets in different colors to help you distinguish targets that are moving and approaching own ship. Use this function to distinguish targets from heavy rain or snow.

Note 1: Requires one of the following radar sensors and GPS position data.

- DRS4D-NXT
- DRS12A-NXT
- DRS6A-NXT
- DRS25A-NXT

Note 2: [Radar Adjust] (Gain, Sea, Rain) and [Auto Sea Mode] cannot be adjusted when the Target Analyzer™ is active.

Note 3: The Target Analyzer™ works only against moving targets. Stationary targets, such as a buoy, are not identified as an approaching target.

Note 4: When the radial component* of target velocity (see below for description) is 50 kn or higher, the target may be painted in a wrong color. For example, an approaching target whose speed is 50 kn or higher should be painted in red, but is painted in green.

* **Radial component of target velocity:** The target velocity can be separated into two components, the radial and transverse components, as in the figure below. The radar is only able to sense the motion directly along the radial, either towards or away from the radar, because the transverse component has no effect on the phase of the returning electromagnetic wave.

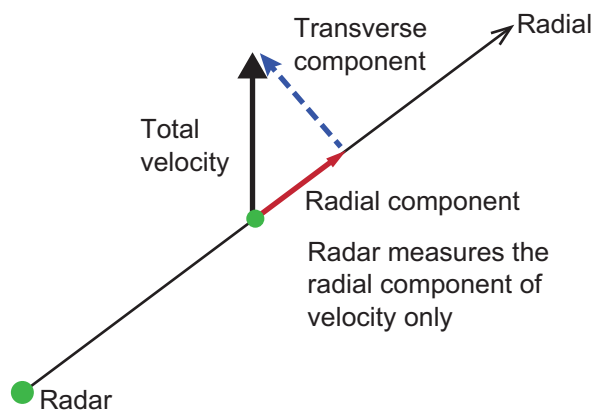

The Target Analyzer™ is activated, deactivated from the Layers menu. Select [Target], [Rain] or [Off] as appropriate. Targets are shown in colors according to the setting on the Layers menu, as shown in the table below.

Setting	Target	Rain	Echo color
[Off]	OFF	OFF	Echoes are painted according to the echo color selected in section 6.19.
[Target]	ON	OFF	Moving targets: Red Other targets: Green
[Rain]	ON	ON	Rain: Blue Moving targets: Red Other targets: Green

6. RADAR

The figure below shows an actual radar image with the Target Analyzer™ activated.

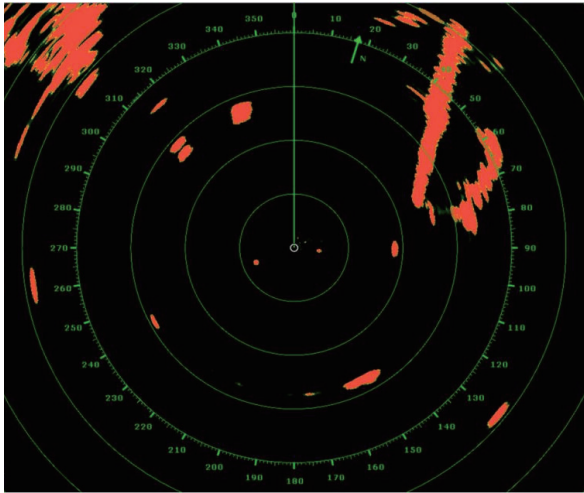

Target Analyzer™: OFF



Target Analyzer™: Target Mode

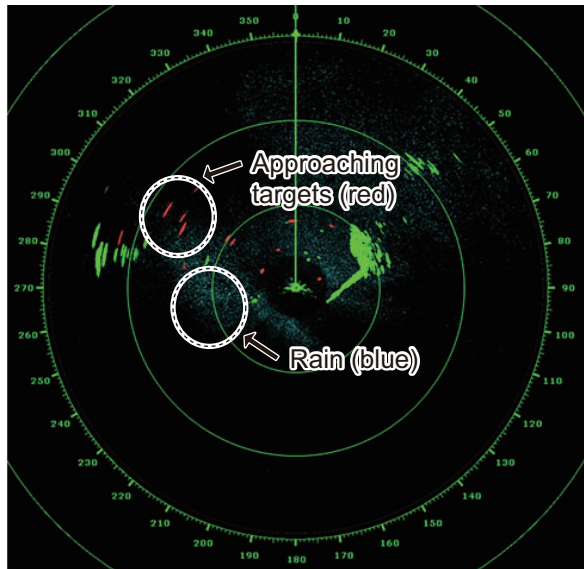

Target Analyzer™: Rain Mode

Operating mode and range

	Range (Target Analyzer™ OFF)	Range (Target Analyzer™ ON)
Single range display	0.063 - 72 NM	0.063 - 24 NM
Dual range display	0.063 - 12 NM	0.063 - 12 NM

6.24 RezBoost™

The azimuth resolution of the radar echoes can DRS4D-NXT/DRS6A-NXT/DRS12A-NXT/DRS25A-NXT/DRS4D-NXT/DRS6A-NXT. Four settings are available, [Standard], [Enhanced1], [Enhanced2], or [Enhanced 3]. Select [Enhanced 3] for better echo resolution.

1. Open the Layers menu.
2. Select [RezBoost].
3. Select desired setting, referring to the figure below for information.

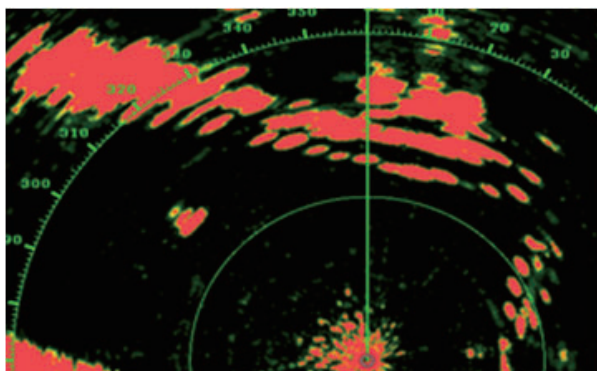

Standard setting
Conventional radar echoes

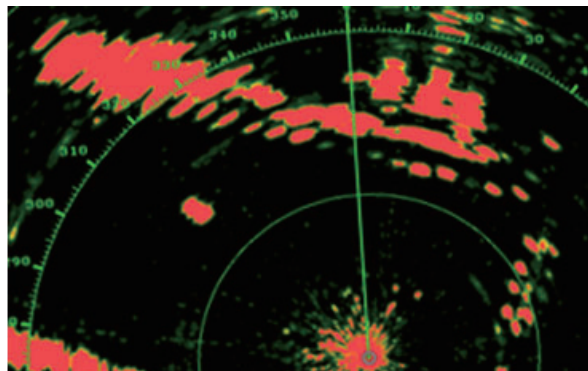

Enhanced 1 setting
Sharper than standard by 1.2 times
Equivalent to 3.4° beam width

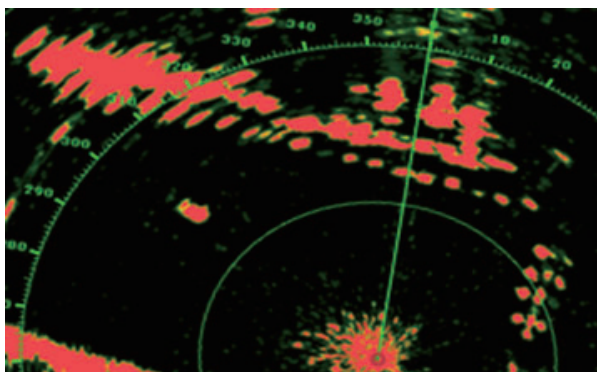

Enhanced 2 setting
Sharper than standard by 1.5 times
Equivalent to 2.7° beam width

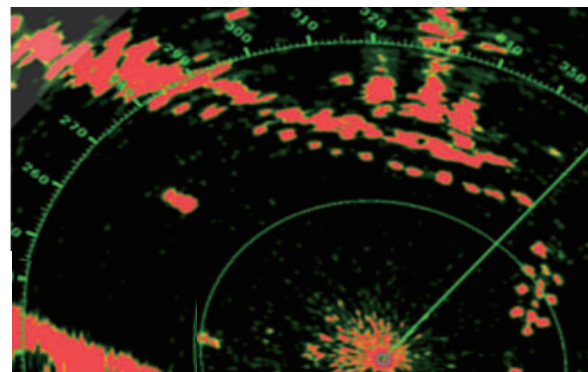

Enhanced 3 setting
Sharper than standard by 2 times
Equivalent to 2.0° beam width

Operating mode and range

Single range: 0.063 to 72 NM, Target Analyzer ON, single range: 0.063 to 24 NM
Dual range: 0.063 to 12 NM, Target Analyzer ON, dual range: 0.063 to 12 NM

6.25 ARPA Operation

The ARPA (Automatic Radar Plotting Aid) tracks manually and automatically acquired radar targets. ARPA requires speed and heading data. The number of targets acquirable is as shown below.

- **No automatic acquisition area:** Targets are acquired manually (max. 30 targets).
- **Automatic acquisition area active:** Targets are acquired both manually and automatically (max. 30 targets total). *
 - * For the DRS4D-NXT/DRS6A-NXT/DRS12A-NXT/DRS25A-NXT, target acquisition by Doppler is as follows:
 - Automatic acquisition: 40 targets
 - Automatic acquisition w/guard zone: 30 targets
 - Manual acquisition: 30 targets

WARNING

No one navigational aid should be relied upon for the safety of vessel and crew. The navigator has the responsibility to check all aids available to confirm position. Electronic aids are not a substitute for basic navigational principles and common sense.

- This auto plotter automatically tracks an automatically or manually acquired radar target and calculates its course and speed, indicating them by a vector. Since the data generated by the auto plotter are based on what radar targets are selected, the radar must always be optimally tuned for use with the auto plotter, to ensure required targets will not be lost or unwanted targets such as sea returns and noise will not be acquired and tracked.

- A target does not always mean a landmass, reef, ships or other surface vessels but can imply returns from sea surface and clutter. As the level of clutter changes with environment, the operator should properly adjust the Sea, Rain and Gain to be sure target echoes are not eliminated from the radar screen.

CAUTION

The plotting accuracy and response of this auto plotter meets IMO standards. Tracking accuracy is affected by the following:

- Tracking accuracy is affected by course change. One to two minutes is required to restore vectors to full accuracy after an abrupt course change. (The actual amount depends on gyrocompass specifications.)
- The amount of tracking delay is inversely proportional to the relative speed of the target. Delay ranges from 15 - 30 seconds for high relative speed; 30 - 60 seconds for low relative speed.

Display accuracy is affected by the following:

- Echo intensity
- Radar transmission pulsewidth
- Radar bearing error
- Gyrocompass error
- Course change (your ship or target)





6.25.1 How to show or hide the ARPA display

From the radar display or chart plotter display, open the Layers menu, then turn [ARPA Targets] on or off (hides ARPA symbols).

6.25.2 How to manually acquire a target

You can manually acquire a target from both the radar display and the radar display overlay. Up to 30 targets can be acquired manually. Tap the target to acquire to show the pop-up menu, then tap [Acquire].

After you acquire a target, the radar marks the target with a broken square and a vector appears within 30 s (default setting). The vector indicates the direction of the target. Within 90 s after you acquire the target, the first tracking step is finished and the target is tracked continuously. At this point, the broken square changes to a solid circle.

ARPA Symbol	Meaning	ARPA Symbol	Meaning
 Color: green	At acquisition of the target.	 Color: green	30 s after the acquisition, the plotting symbol changes to a small circle, which indicates steady-state tracking. A vector (dashed line) shows the direction of the target.
 Color: green	A lost target is indicated by a diamond symbol, created from two equal triangles.	 Color: red	A target that meets the criteria of the CPA/TCPA alarm is changed to a dangerous target.

Note 1: For successful acquisition, the target must be within 0.05 to 16 NM from your ship and not hidden in sea or rain clutter.

Note 2: When the capacity for manual acquisition is reached, you cannot acquire more targets. Cancel tracking of non-threatening targets to acquire additional targets manually.

6.25.3 How to automatically acquire a target

Any target that enters the ARPA acquisition area is acquired and tracked automatically. When a target enters the area, the buzzer sounds. To disable the buzzer, set [Alarm] to [OFF] in the pop-up menu at step 2 in the below procedure.

1. Create a guard zone referring to section 6.14.
2. Tap a line on the guard zone to show the pop-up menu. Turn on [Auto Acquire]. The dotted lines for the guard zone turn into solid lines.
3. Turn on [Auto Acquire]. The dotted lines for the guard zone turn into solid lines.

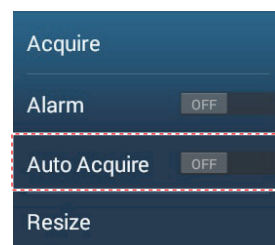

6.25.4 How to automatically acquire targets by Doppler

With acquisition by Doppler active, you can track up to 100 targets in total as follows.

- 40 targets by auto acquire by Doppler
- 30 targets by auto acquire by guard zones
- 30 targets by manual tracking

When automatic acquisition by Doppler is activated, approaching targets (ships, rain clutter, etc.) within 3 NM from own ship are automatically acquired by the Doppler calculated from the radar echo.

This feature, when active, runs in the background immediately after the start of transmission. Targets are acquired in order of distance from own ship, from nearest to furthest. Once a target is acquired, tracking continues regardless of subsequent Doppler behavior, even if the target becomes stationary. Targets can still be manually acquired provided that the capacity for automatic acquisition has not been reached.

Auto acquisition by Doppler is [OFF] in the default setting. To activate this feature, open the [Radar] menu, then turn on [Auto acquire by Doppler].

This feature requires the radar sensor DRS4D-NXT/DRS6A-NXT/DRS12A-NXT/DRS25A-NXT and position and heading inputs.

6.25.5 How to display target data

You can find the bearing, range, etc. of an ARPA target. Tap the ARPA target to get its simple information in the pop-up menu. For detailed information, tap the ARPA target to display the pop-up menu, then tap [Info].

ID	18
COG	239.8 °
SOG	41.2 kn
Range	2.262 NM
Bearing	244.7 °
CPA	1.682 NM
TCPA	3'07s
Acquire	
Cancel	
Clear	
New Point	
Info	

Simple information

ID	18
COG	242.7 °
SOG	39.2 kn
CPA	1.534 NM
TCPA	3'07s
Range	2.193 NM
Bearing	245.7 °
Status	Tracking
Lat	N 26°29.045'
Lon	W 79°44.501'

Detailed information

6.25.6 How to stop tracking targets

You can stop tracking ARPA targets individually or all together.

Individual target

Tap the ARPA target to display the pop-up menu, then tap [Cancel] to stop tracking and delete the ARPA target from the screen.

All targets

Open the Slide-out menu, tap [ARPA], then tap [Cancel All] to delete all targets from the screen.

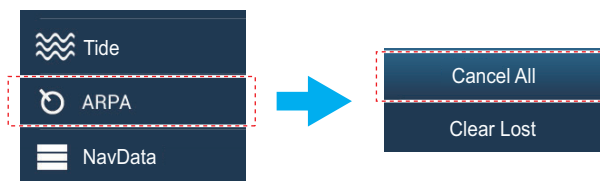

6.25.7 ARPA list

The [ARPA] list displays data for all ARPA targets being tracked.

How to show the ARPA list

To show the list, go the Home screen, then tap [Lists]→[ARPA]. The color bars at the left side of the list denote ARPA symbol status, green for tracking or lost target, red for dangerous target.

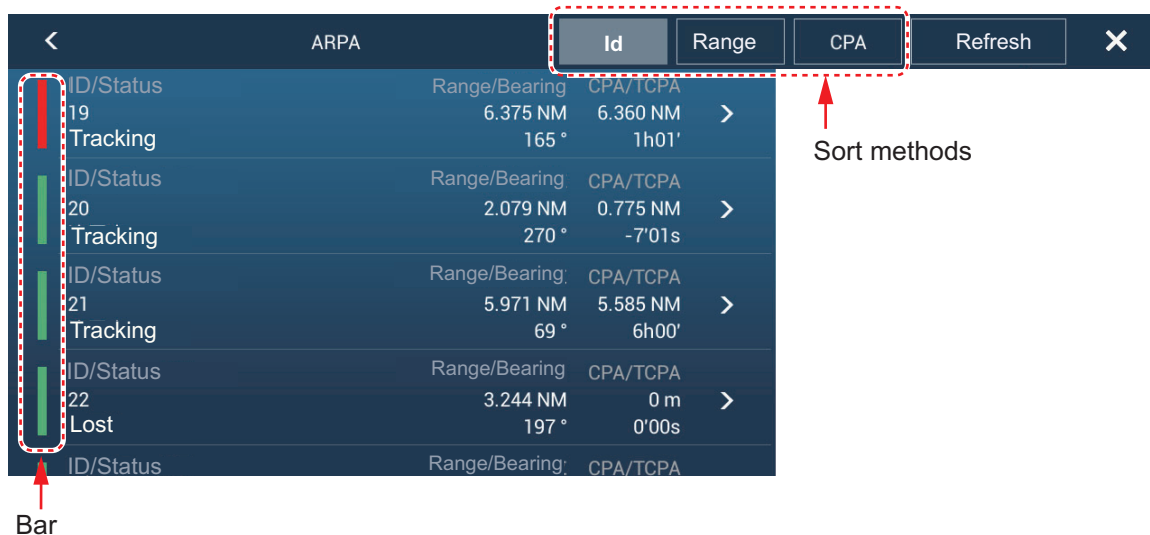

To sort the list, tap appropriate sort method button at the top of the list.

[ID]: Sort by ID no.

[Range]: Sort by range, closest to furthest from own ship.

[CPA]: Sort in CPA order.

The [Refresh] button updates target data.

How to show detailed ARPA target information

Tap the target on the [ARPA] list to see its information.

ID	18
COG	242.7 °
SOG	39.2 kn
CPA	1.534 NM
TCPA	3'07s
Range	2.193 NM
Bearing	245.7 °
Status	Tracking
Lat	N 26°29.045'
Lon	W 79°44.501'
ACTIONS	
Find on Chart	

How to put an ARPA target at the center of the chart plotter display

Tap a target on the list. Tap [Find on Chart] to put the ARPA target at the center of the chart plotter display.

6.25.8 How to clear lost targets

Tracking of a target cannot be continued when the echo from that target becomes lost. A lost target can be tracked after it is reacquired. Lost targets can be erased individually or collectively.

Individual target

Tap the target to display the pop-up menu, then tap [Clear] to remove the target from the screen.

Clear all targets

Open the Slide-out menu, tap [ARPA], then tap [Clear Lost] to delete all lost targets from the screen.

6.25.9 CPA/TCPA alarm

This alarm helps you keep your ship away from collision by warning of targets on a collision course. The ARPA continuously monitors the predicted range at the Closest Point of Approach (CPA) and predicted time to CPA (TCPA) of each tracked target. When both the predicted CPA and TCPA are less than their set values, the target symbol turns red, the alarm sounds and the flashing message "CPA/TCPA Alarm" appears at the top of the screen.

CPA/TCPA alarm ranges must be set correctly according to the size, tonnage, speed, turning performance and other characteristics of your ship.

How to set the CPA/TCPA alarm

1. Open the Home screen, then tap [Settings]→[Targets].
2. Turn on [CPA/TCPA Alarm].
3. Tap [CPA Alarm Value] or [TCPA Alarm Value] to display the software keyboard.
4. Set the value, then tap [✓] to confirm.
5. Tap the close button on the title bar to finish.

How to acknowledge the CPA/TCPA alarm

The CPA/TCPA alarm sounds when the CPA and TCPA of an ARPA target are within the CPA/TCPA alarm range. The alarm indication "CPA/TCPA Alarm" appears and flashes at the top of the screen. To acknowledge the alarm and stop the audio alarm and flashing of the indication, tap the indication "CPA/TCPA Alarm" (see subsection 2.10.9). (The ARPA vector must be displayed at least 30 seconds to calculate CPA and TCPA.)

How to deactivate the CPA/TCPA alarm

1. Open the Home screen, then tap [Settings]→[Targets].
2. Turn off [CPA/TCPA Alarm].
3. Tap the close button on the title bar to finish.

6.25.10 CPA graphic display

The CPA graphic display shows the CPA between own vessel and the selected ARPA (or AIS) target with a line, called the "CPA line." Whenever you change your vessel's course and speed, you can see the new CPA between your vessel and the selected ARPA target.

To activate or deactivate the CPA graphic display, open the [Targets] menu and turn [CPA Graphic Display] on or off.

To find the CPA of a ARPA target on the radar or chart plotter display, tap the ARPA target. The CPA line connects between your vessel and the CPA of the ARPA target. The color of the line is the same as that of the target symbol. To find the CPA of another ARPA target, select it, and the CPA line moves to the newly selected target. (Only one line can be displayed at a time.) The example at right shows the appearance of the CPA line on the radar display.

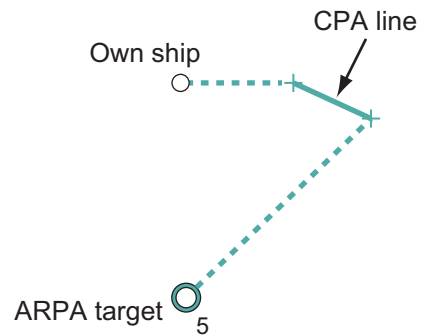

If the CPA/TCPA alarm is generated while the CPA line is in use, the CPA line and the symbol of the selected target turn red.

The CPA graphic display is not available in the following conditions:

- The CPA line is turned off. The line can be turned off by tapping the CPA line (or own ship icon* or target) to show the pop-up menu, then select [CPA].
* Chart plotter display only
- The feature is turned off.
- The TCPA is a minus (-) value.
- The target is a lost target.
- The CPA and TCPA of the target cannot be calculated (no speed or heading data for own ship).

6.26 Connecting With FAR-2xx7/FAR-15xx Series Marine Radars

Your NavNet TZtouch3 can connect with the FAR-2xx7 series and FAR-15xx series Marine Radars. The following radar type and software version restrictions apply; FAR-15xx series: Non IMO-types only with software version 01.19, or later. FAR-2xx7 series: C-types only with software version 04.08, or later.

Note 1: Polygon acquisition zones must be also be disabled at the radar.

Note 2: For FAR-15xx series users, the Echo Average function is only applied to images from EAV1 when displayed on your TZtouch3 unit.

Radar function	Available from the TZtouch3	Remarks
Split-screen display	Not available	
Display AIS target data	Available	
ARPA automatic acquisition	Not Available	
ARPA manual acquisition and removal	Available	Up to 100 targets.
AUTO RAIN	Not available	
AUTO SEA	Available	ON/OFF operation only, setting adjustment must be done at the radar.
Automatic gain adjustment	Not available	
Manual rain/snow clutter removal	Available	
Manual gain adjustment	Available	
Toggle transmit and standby modes	Available	
Interference Rejector	Available	
Tuning, antenna sped and other post-installation adjustments	Not available	
Radar source selection, display of echoes	Available	
Selection of range unit	Not available	Fixed at [NM].
Changing the range	Available	Following ranges only: 0.125, 0.25, 0.5, 0.75, 1, 1.5, 2, 3, 4, 6, 8, 12, 16, 24, 32, 48, 96 (nm).
Watchman feature	Not available	
ACE GAIN	Available*	*: This function is only available for the FAR-15xx series and requires ACE GAIN to be enabled from the radar.

6.27 Radar Menu

This section provides the descriptions for the radar menu items not mentioned earlier.

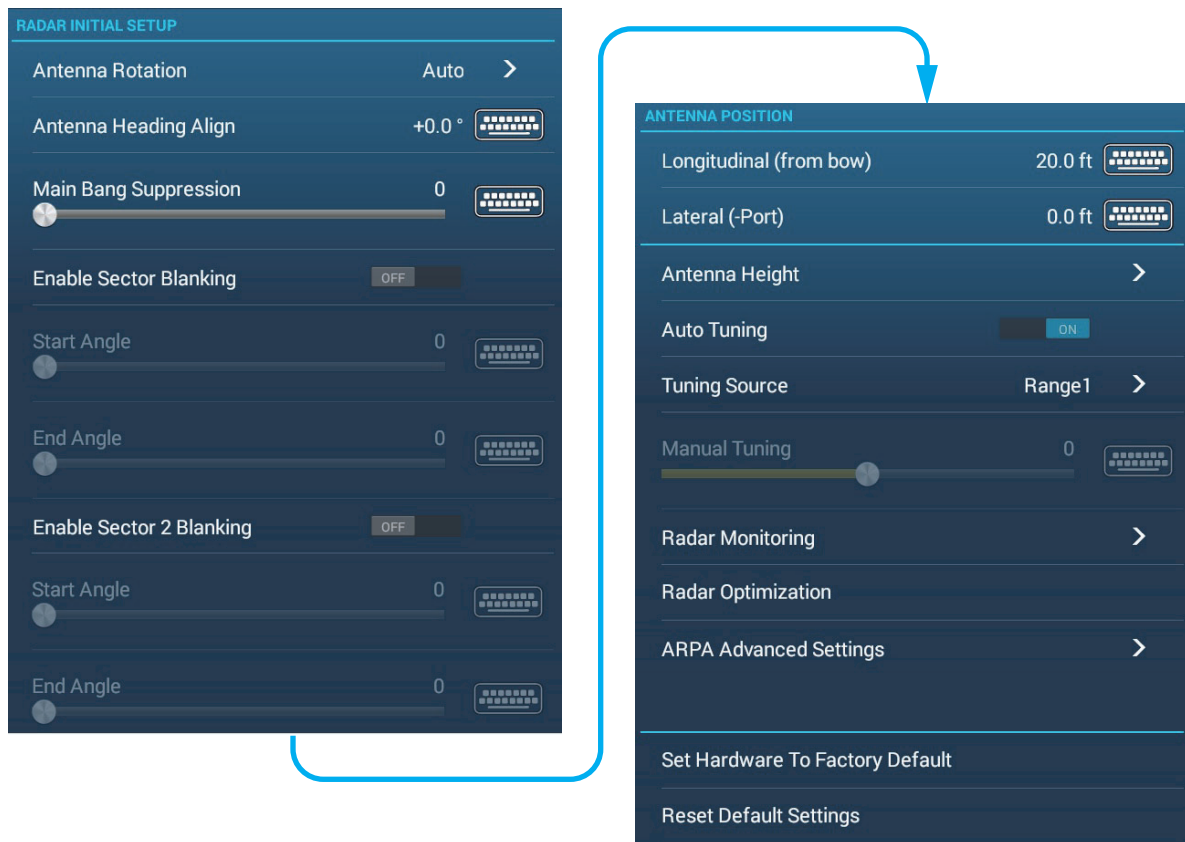

RADAR INITIAL SETUP section

[Antenna Rotation]: Starts or stop antenna rotation. For the serviceman. See the installation manual.

[Antenna Heading Align]: Compensates for error in positioning of the antenna unit at installation. See the installation manual for the adjustment procedure.

[Main Bang Suppression]: Reduces main bang, the clutter appearing at the screen center. See the installation manual for the adjustment procedure.

[Enable Sector Blanking]: Sets the area(s) where to prevent transmission. For example, set the area where an interfering object at the rear of the antenna would produce a dead sector (area where no echoes appear) on the display. See the installation manual for the procedure.

ANTENNA POSITION section

[Longitudinal (from bow)], [Lateral (-Port)]: Set the position of the radar antenna in relation to the bow and port.

Other items

[Antenna Height]: Set the height of the radar antenna above the waterline. Not available (grayed out) with the radar sensor DRS4DL/DRS4DL+.

[Auto Tuning]: Activate or deactivate auto tuning for the connected radar. Not available (grayed out) with the radar sensor DRS4D-NXT.

[Tuning Source]: For the dual range display, select the range to use as the manual tuning source. Not available (grayed out) with the radar sensor DRS4DL/DRS4DL+, DRS4D-NXT.

[Radar Monitoring]: Show various voltage levels, and ARPA data. For the service technician.

[Radar Optimization]: Automatically adjust magnetron output and tuning for the connected radar. **Be sure to do this after replacing the magnetron.** Not available (grayed out) with the radar sensor DRS4D-NXT.

[ARPA Advanced Settings]: Sets ARPA parameters. For the service technician only. Do not change the settings. Set [TX/STBY] to [ON] to access. Not available (grayed out) with the radar sensor DRS4DL/DRS4DL+, FAR-2xx7 series radar antenna.

[Set Hardware to Factory Default]: For the service technician only.

[Reset Default Settings]: Restore default settings for radar items other than those in the [RADAR INITIAL SETUP] section.

6.28 How to Interpret the Radar Display

6.28.1 False echoes

Echo signals can appear on the screen at positions where there is no target or disappear where there are targets. You can identify false targets when you understand why the false echoes appear. A description of false echoes follows.

Multiple echoes

Multiple echoes occur when a transmitted pulse returns from a solid object like a large ship, bridge, or breakwater. A second, a third or more echoes can be seen on the screen at two, three or more times the true range of the target as shown below. You can reduce and sometimes remove these multiple echoes if you decrease the gain, or correctly adjust the sea clutter.

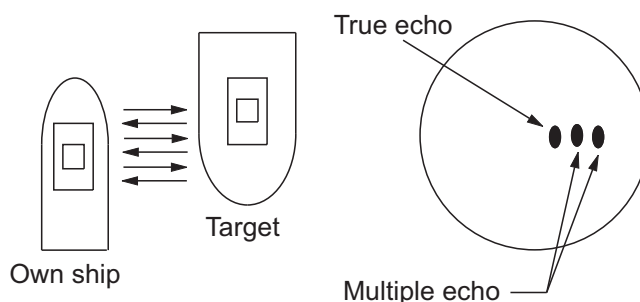

Virtual image

A large target near your ship can show at two positions on the screen. One of the positions is the true echo reflected by the target. The other position is a false echo which is caused by the "mirror effect" of a large object on or near your ship. See the figure shown below for an example of this type of false echo. If your ship gets near a large metal bridge, for example, a false echo appears on the screen. The echo disappears after move some distance from the bridge.

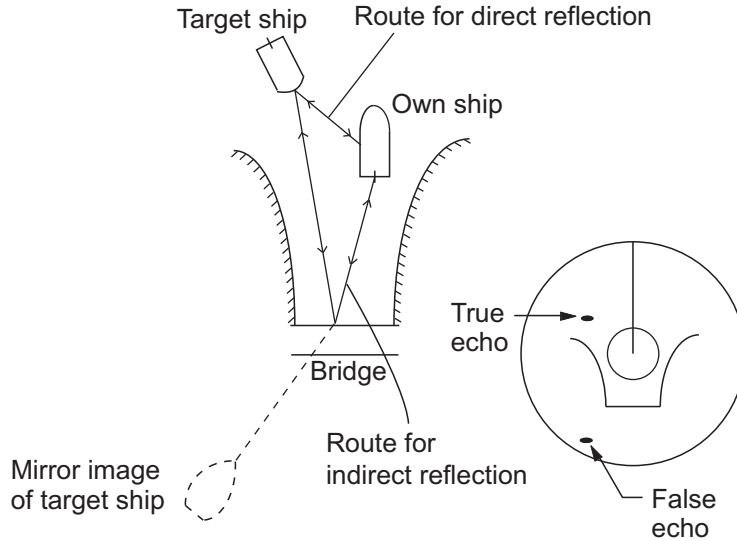

Sector blanking

Funnels, stacks, masts, or derricks in the path of the antenna stop the radar beam. If the angle opposite the antenna is more than one or two degrees, a sector or shadow sector appears on the screen. Targets are not displayed within the sector.

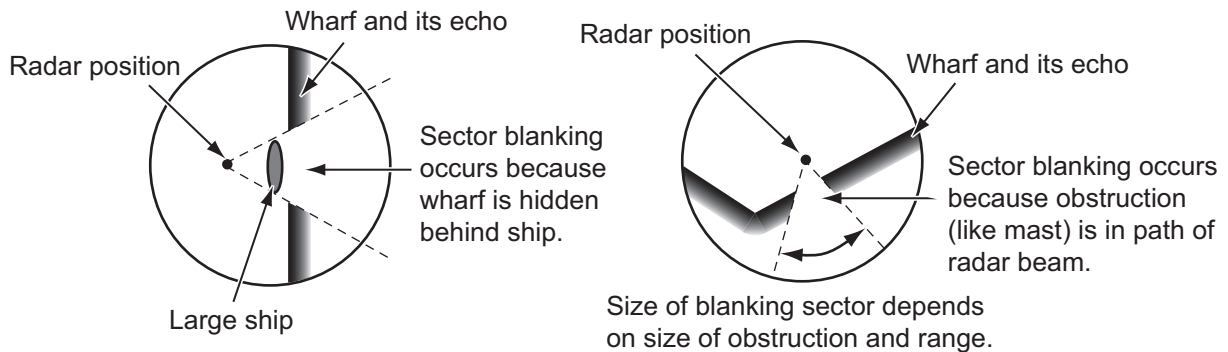

Sidelobe echoes

Each time the radar transmits, some radiation leaves on each side of the beam. This lost energy has the name "sidelobes" If a target is detected by both the sidelobes and the mainlobe, the sidelobe echoes can appear at both sides of the true echo at the same range. Sidelobes normally show only on short ranges and from strong targets. You can reduce sidelobes if you reduce the gain, or correctly adjust the sea clutter.

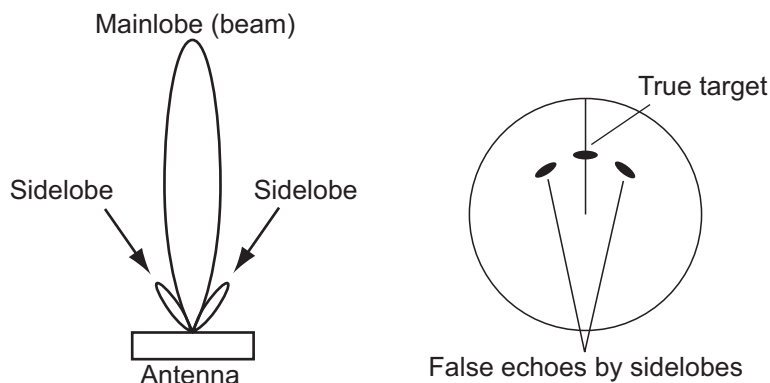

6.28.2 Search and rescue transponder (SART)

A ship in distress uses a radar-SART to show a series of dots on the radar display of nearby ships to indicate distress. A SART transmits when it receives a radar pulse from any X-Band (3 cm) radar within a range of approximately 8 nm. When a SART receives a radar pulse, the SART transmits a response across all the radar frequency band.

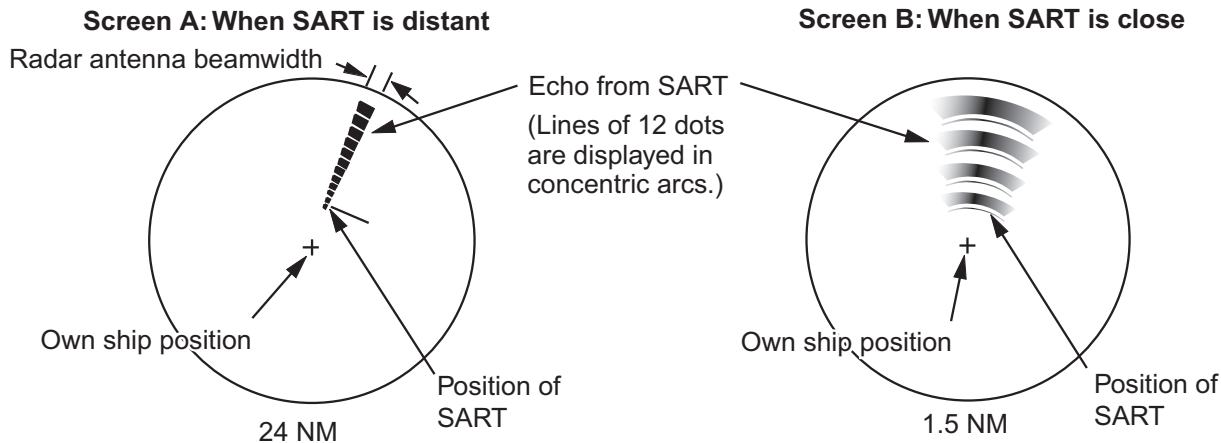

How to detect the SART response

- Use the range scale of 6 or 12 NM.
- Turn off all the automatic clutter filters.
- Turn off the interference rejector.

6.28.3 RACON (Radar Beacon)

A RACON is a radar transponder that sends a characteristic signal when the RACON receives a radar pulse (normally only the three-centimeter band). If the RACON signal is sent on the same frequency as that of the radar, the signal appears on the radar display. The RACON signal appears on the radar in one of two methods:

- A line that starts just after the position of the RACON
- A Morse code signal displayed with a line just after the position of the RACON.

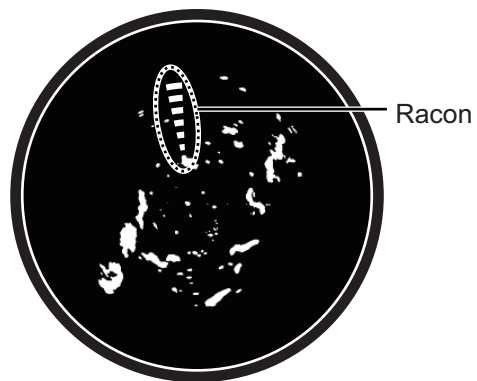

7. FISH FINDER (SOUNDER)

This chapter describes the functions of the built-in fish finder.

The fish finder is set up from the [Fish Finder] menu, which can be opened by the following two methods.

- From the Home screen, tap [Settings]→[Fish Finder].
- With the fish finder display active, open the Layers menu, then tap [Fish Finder Setting].

Unless otherwise written, this manual uses the first method.

Note 1: To change the fish finder source, open the [Fish Finder] menu, tap [Fish Finder Source], then tap the source to use. The source can also be selected from the Layers menu with [Fish Finder Source].

Note 2: The names of menu items change according to the fish finder source.

7.1 How the Fish Finder Operates

The fish finder calculates the distance between its transducer and underwater objects like fish, lake bottom or seabed. The results are shown in different colors or shades of gray according to echo strength.

The ultrasonic waves transmitted through water move at a constant speed of approximately 4800 feet (1500 meters) per second. When a sound wave "hits" an underwater object like fish or sea bottom, part of the sound wave is reflected toward the source. To find the depth to an object, the fish finder calculates the time difference between the transmission of a sound wave and the time the reflected sound wave is received.

The picture displayed by the fish finder contains a series of vertical scan lines. Each line is a "picture" of the objects under the boat. The series of pictures are put side-by-side across the screen to show the contours of the bottom and echoes from fish. The amount of history of objects that have moved under the boat can be less than a minute to more than one minute depending on the picture advance speed.

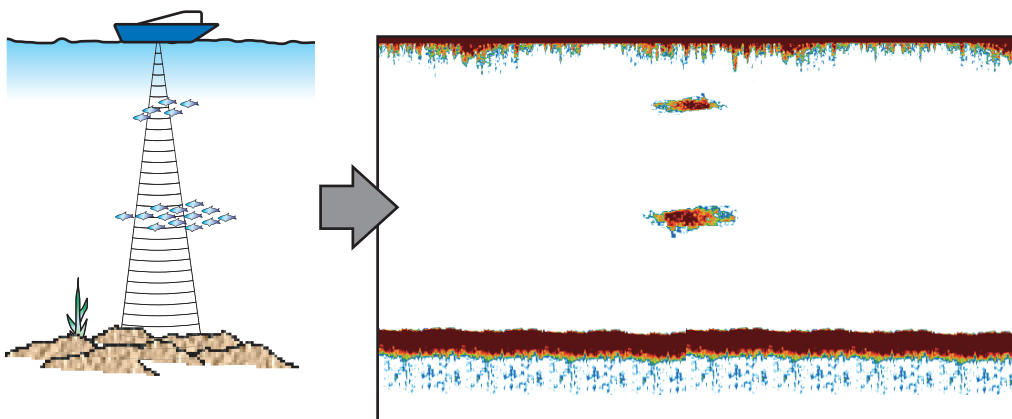

7.2 How to Transmit, Go to Stand-by

From the Home screen, tap the Fish Finder icon to activate the fish finder. Open the Layers menu, then tap the flipswitch [TX/STBY]. Select [ON] to transmit; [OFF] to go to stand-by. "Stand-by" appears at the screen center when in stand-by.

7.3 How to Select a Display

Your fish finder has four display modes, single frequency, dual frequency, bottom lock, and bottom zoom. A-scope or bottom discrimination displays can also be displayed together with each of the four display modes.

7.3.1 Single frequency display

The single frequency display shows either the low-frequency or high-frequency picture over the entire screen. Select a frequency according to your purpose, considering the description below.

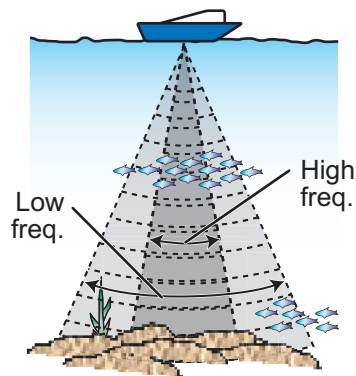

- A low frequency gives a wide detection area. Use the low frequency for general search and to find bottom conditions.
- A high frequency gives better resolution. Use the high frequency to inspect a school of fish in detail.

How to select a single frequency display

1. Open the Layers menu.
2. Tap [Single Freq] at [Display Mode].
3. Turn on [Single Freq.].

How to switch between the low- and high-frequency displays

You can switch between the low- and high-frequency displays by tapping the frequency icon, which is at bottom of the screen.

Note: In the same way as shown in the figure, you can switch the video on the side-by-side screen and enlarged screen explained in the following sections by the above method.

Side-by-side screen: Swap low frequency and high frequency images (factory default, low frequency on the left and high-frequency on the right).

Zoomed screen: Switch between single frequency (low frequency, high frequency).

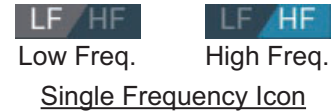

Single Frequency Icon

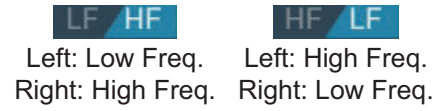

Dual Frequency Icon

7.3.2 Dual frequency display

The dual frequency display provides both low and high frequency pictures, the low frequency on the left half (default). Use the dual frequency display to compare the same picture with two different sounding frequencies.

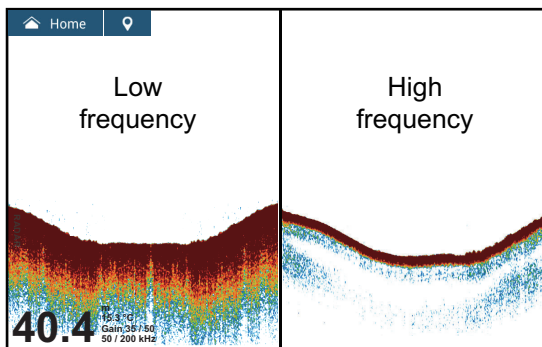

Freq. (kHz)	Beamwidth	Resolution	Detection range	Bottom tail
Low	Wide	Low	Deep	Long
High	Narrow	High	Shallow	Short

How to select the dual frequency display

On the Layers menu, then tap [Dual Freq] at [Display Mode].

How to set separate ranges for the low- and high-frequency displays

1. Open the [Fish Finder] menu.
2. Turn on [Split Range]. A message informs you that ACCU-FISH™ will be disabled when the split range is used.
3. Tap [OK].
4. Tap the close button on the title bar to finish.
5. Pinch the high- and low-frequency displays to change their range.

Note: The slider bar can be used to adjust the range of the image shown on the left-half of the screen.

7.3.3 Zoom displays

Zoom mode expands selected area of the single frequency picture. Three modes are available: bottom lock, bottom zoom, and marker zoom.

How to activate, deactivate a zoom display

Open the Layers menu. Tap [Bot. Lock], [Bot. Zoom] or [Marker Zoom] at [Display Mode], To quit the zoom display and go to the single frequency display, open the Layers menu, then tap [Single Freq] at [Display Mode].

Bottom lock display

The bottom lock display provides a compressed normal picture on the right half and a 7 to 400 feet (2 to 120 meter) wide layer in contact with the bottom is expanded on the left half. This display helps you separate the fish near the bottom from the bottom echo. You can select the bottom lock range with [Bottom Lock Range Span] in the [Fish Finder] menu.

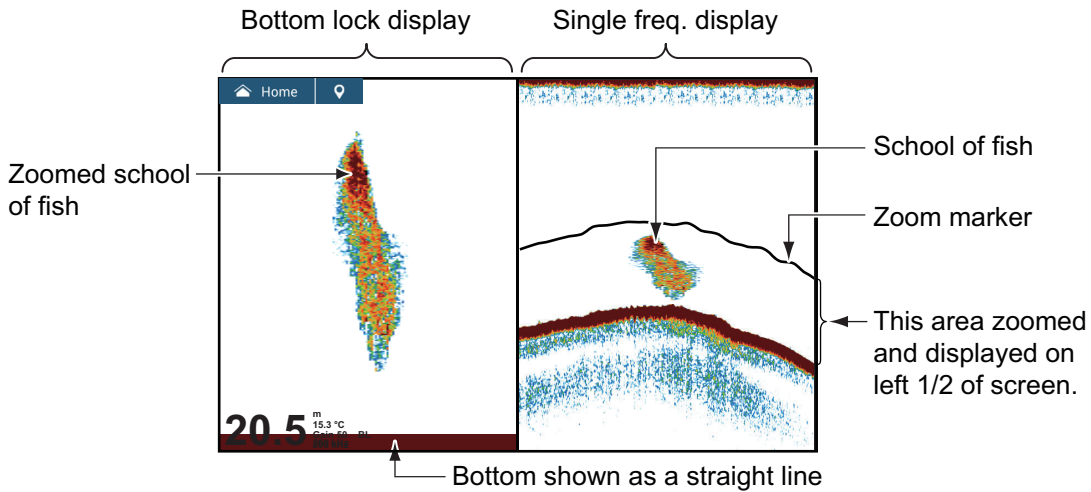

Bottom zoom display

The bottom zoom display expands the bottom and the fish near the bottom according to the zoom range selected on [Zoom Range Span] in the [Fish Finder] menu. This display helps you find the density of the bottom. A short echo tail normally indicates a soft bottom (sand bottom, etc.). A long echo tail indicates a hard bottom.

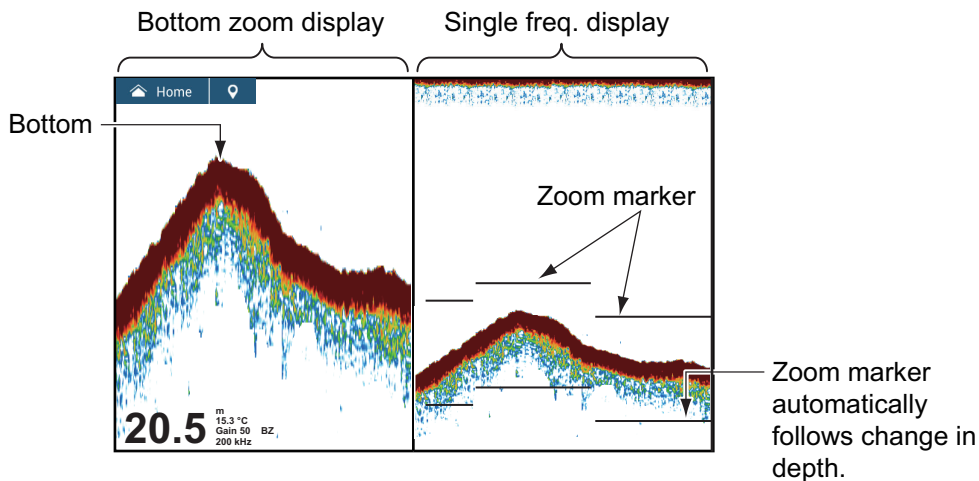

Marker zoom display

The single frequency picture is shown on the right half of the screen, and the area surrounded by the yellow enlargement marker on the right-half of the screen is enlarged on the left half. This display is useful for determining the size of a school of fish in the middle layer.

To change the range of the zoom marker, pinch on the screen, operate the slider bar, or use the menu item [Bottom Lock Range Span], in the [Fish Finder] menu. To shift the zoom marker (see section 7.4), drag it up or down on the screen, or use [Marker Zoom Shift] from the [Fish Finder] menu to set the start position (top of marker) of the zoom marker. For TZT9F/12F, you can also adjust the marker by turning the Ro-toKey™.

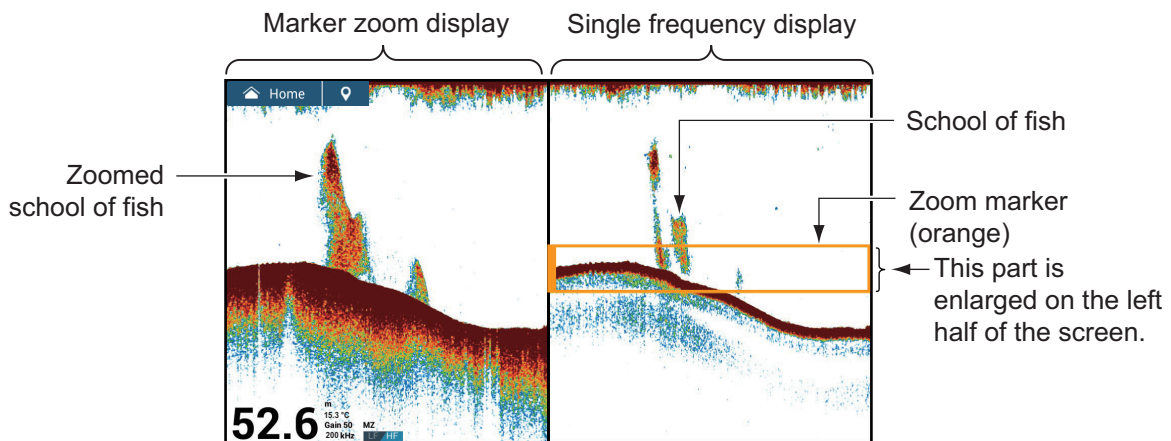

7.3.4 A-scope display (monitoring only)

The A-scope display appears at the right of the screen and is available in any display mode. This display shows the echoes at each transmission with the amplitudes and tone in balance with their intensities. This display helps you identify possible fish species and bottom structure.

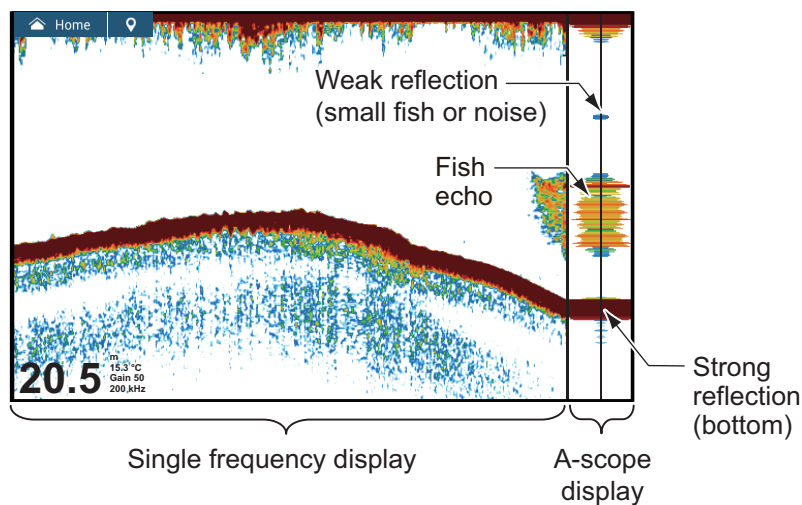

How to show or hide the A-scope display

Tap the screen to show the pop-up menu, then turn [A-Scope] on or off.

7. FISH FINDER (SOUNDER)

A-scope peak hold

You can show the peak-hold amplitude image on the A-scope display. With [A-Scope Peak Hold] turned on, the image is slowly erased to help discern amplitude condition more easily.

1. Open the Home screen, tap [Settings]→[Fish Finder]→turn on [A-Scope Peak Hold].
2. Tap the close button on the title bar to finish.

7.3.5 Bottom discrimination display

The bottom discrimination display, which requires a bottom discrimination capable transducer or Bottom Discrimination Sounder BBDS1 or Network Fish Finder DFF1-UHD, identifies probable bottom composition. The display is available in all screen divisions, single or dual frequency mode, and occupies the bottom 1/6 of the screen in the full screen display.

Use this feature with ship speed 10 knots or less and depths between 5 and 100 m.

Note 1: Composition estimate accuracy may be affected when the transducer is not parallel with the seabed.

Note 2: Picture advance speed become slow while the bottom discrimination display is active.

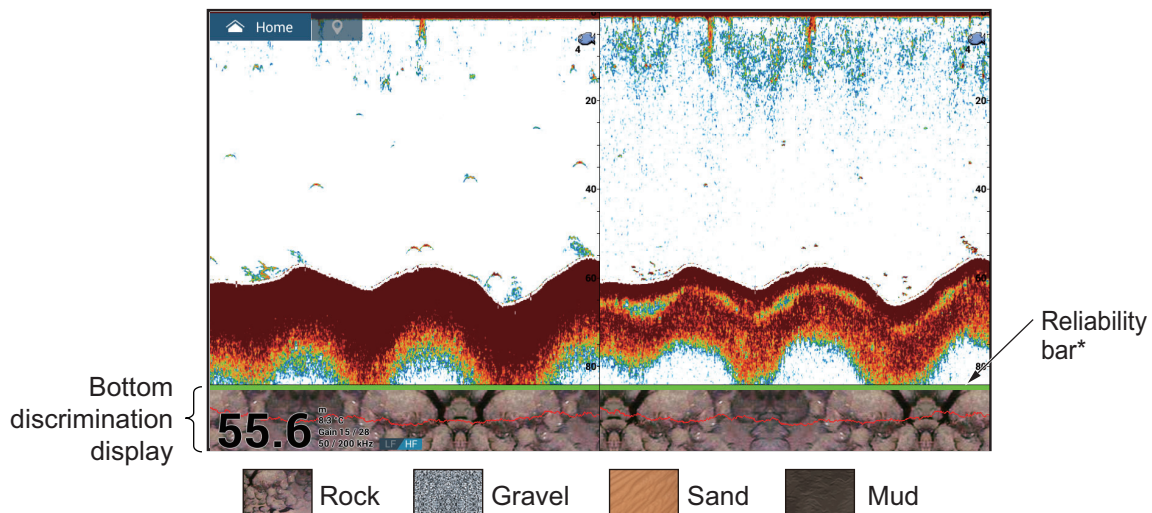

Sand and rock are the most likely bottom type in this example.

* Reliability of bottom discrimination display shown with a color.

- Green: Normal
- Yellow: Caution
- Background color: Abnormal

How to activate or deactivate the bottom discrimination display

1. Open the Home screen, then tap [Settings]→[Fish Sounder]→[Fish Finder Source].
2. Tap [TZZ9F], [TZZ12F], [TZZ16F], [TZZ19F], [BBDS1] or [DFF1-UHD] as applicable. For internal fish finder, select [TZZ9F], [TZZ12F], [TZZ16F] or [TZZ19F] as applicable. Fish finder source can also be selected from the Layers menu.
3. Tap the close button on the title bar to finish.
4. On the Layers menu, set [Bottom Discrimination] to [ON] or [OFF] as appropriate.

How to display bottom discrimination display information

Tap the bottom discrimination display to show bottom discrimination information, an example of which is shown right.

The bottom discrimination display can be turned off from the pop-up menu with [Bottom].

The percentage of main bottom type is also displayed in the graph.

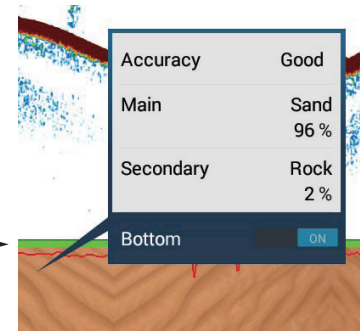

7.4 How to Select the Range

The range can be selected automatically or manually. To set the range selection method, open the Layers menu, then set [Auto Range] to [ON] (automatic) or [OFF] (manual) as appropriate.

Automatic range selection: The range is automatically changed to display the bottom echo. The slider bar for range adjustment is turned off on modes other than bottom lock* and bottom zoom*.

* The range for the bottom lock and bottom zoom displays can be adjusted with the slider bar.

Manual range selection: Pinch the screen to change the range. Additionally, you can adjust the range with the slider bar at the right side of the screen. Drag the slider knob, or tap the [+] or [-] symbol at the top, bottom of the bar. The slider bar can be disabled with [Show Range Slider] in the [Fish Finder] menu.

How to shift the display range

You can shift the display range up or down to see deep or shallow place. This function is disabled during auto range operation. To shift the display range, drag the screen up or down.

7.5 How to Adjust the Gain

Gain can be adjusted automatically (two methods, fishing, cruising) or manually.

7.5.1 Automatic gain adjustment

The automatic gain adjustment feature is convenient when you don't have the time to adjust the gain because you are busy with other tasks. With the automatic gain mode activated, gain, clutter, and TVG are automatically adjusted. The main functions of the automatic mode are as shown below.

- The gain is automatically adjusted to show the bottom echo in reddish-brown color.
- The clutter function removes weak echoes such as noise and plankton.
- TVG is automatically adjusted.
- The gain between low- and high-frequencies is automatically adjusted.

7. FISH FINDER (SOUNDER)

There are two types of automatic gain adjustment, fishing and cruising.

[Auto Fishing]: The gain is automatically adjusted to emphasize weak echoes from schools of fish. Use this mode for fishing. Select from the Layers menu. When this mode is active, the indication [Gain Auto F] appears at the bottom left corner.

[Auto Cruising]: The gain is automatically adjusted to suppress weak echoes and emphasize the bottom echo. Use this mode for cruising. Select from the Layers menu. When this mode is active, the indication [Gain Auto C] appears at the bottom left corner.

To select an automatic gain adjustment mode, open the Layers menu, then tap [Auto Fishing] or [Auto Cruising] as appropriate.

7.5.2 Manual gain adjustment

To adjust the gain manually, open the Layers menu, then activate [Manual Gain] at [Gain Mode].

The gain controls how echoes of different strengths are displayed. Set the gain to show a slight amount of noise on the screen. Increase the gain for greater depths and lower the gain for shallow waters. The figures below show examples for gain set too high, too low and with a proper setting, for reference.

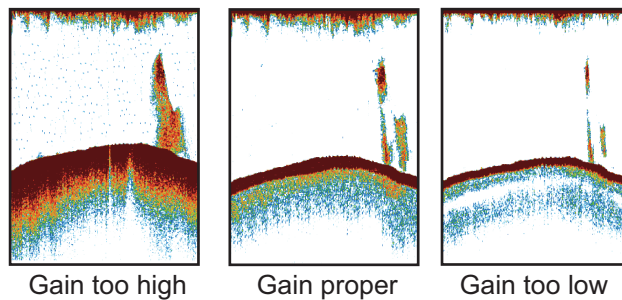

You can adjust the gain two ways.

Method 1: Layers menu

1. Open the Layers menu, then tap [xx kHz Gain]. (xx=transducer frequency, according to transducer used.)
2. Using the slider bar at right edge of the screen, drag the handle or tap the [+] or [-] symbol to adjust the gain. The gain setting is applied to both current and past echoes.
3. Tap [Done] at the top of screen to finish.

Method 2: Two finger tap

Note: Set [Two Finger Tap Function] (or [Two Finger Long Tap Function]) to [Gain Control] in the [General] menu to enable on-screen gain adjustment. See section 1.16.

Tap (long tap) the screen with two fingers to show the Gain slider bar. Adjust the slider bar referring to the illustration above.

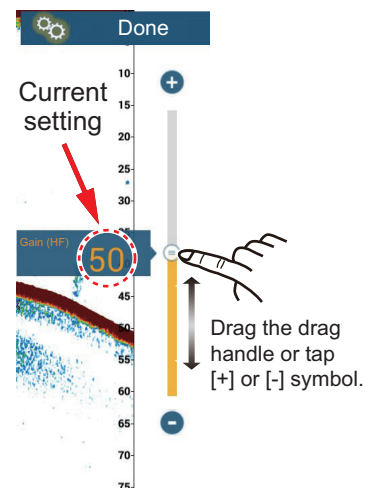

Method 3: Fish Finder/or Multi beamSonar box in the data area

Follow the procedure in section 1.9.2, section 1.9.3 to add [Fish Finder Gain Control] or [Multi-Sounder Gain Control] box in the data area. Then, do as follows:

1. Show the fish finder display, multi-beam sounder display, side scan display, or cross-section display. Tap [FISH FINDER] or [DFF3D] at the bottom of the data area.
2. Tap [HF Gain], [LF Gain], then [M](Manual) or [A](Automatic). Tap [M]/[A] to alternately select Manual, Automatic. For manual gain adjustment, go to the next step.
3. Tap the numeric of the gain frequency tapped in step 2.
4. Use the slider bar at the right edge of the screen to adjust the gain - drag the knob or tap the [+], [-] symbols.
5. Tap [Done] at the top-right corner of the screen to finish.

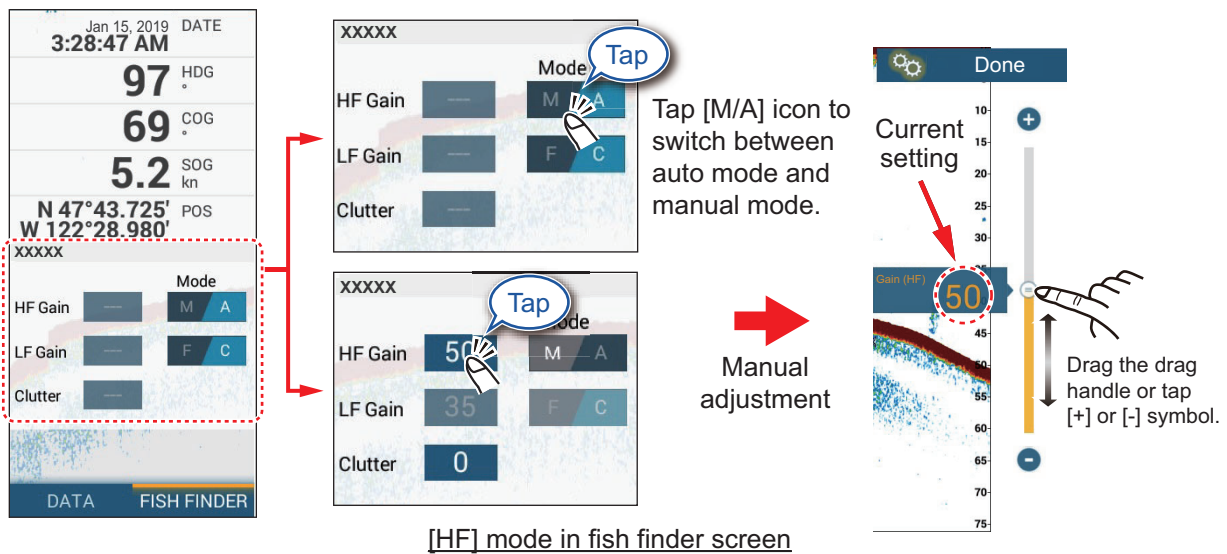

7.6 How to Reduce Clutter

Low intensity "spots" of noise appear over most of the screen like in the illustration shown right. These spots are caused by sediment in the water or noise. You can reduce this type of noise with the clutter function.

Note: This function is not available in the auto mode.

Method 1: Layers menu

1. Open the Layers menu, then tap [Clutter].
2. The slider bar for clutter adjustment appears at the right side of the screen. Drag the slider bar to set the degree of clutter reduction. The larger the setting, the greater the degree of reduction.
3. Tap [Done] at the top right-corner of the screen to finish.

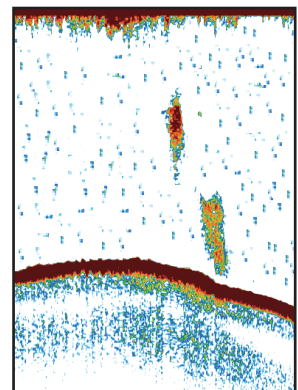

7. FISH FINDER (SOUNDER)

Method 2: Fish Finder menu

1. Open the Home screen, then tap [Settings]→[Fish Finder].
2. Drag the slider at [Clutter] to set the degree of clutter reduction. The larger the setting the greater the degree of reduction.
3. Tap the close button on the title bar to finish.

Method 3: Data area

Follow the procedure in section 1.9.2, section 1.9.3 to add [Fish Finder Gain Control] or [Multi-Sounder Gain Control] box in the data area. Then, do as follows:

1. Show the fish finder display, multi-beam sounder display, side scan display, or cross-section display. Tap [FISH FINDER] or [DFF3D] at the bottom of the data area.
2. Tap [Clutter].
3. Drag the circle on the slider bar to adjust the clutter.
4. Tap [Done] at the top right-corner of the screen to finish.

7.7 Picture Advance Speed

The picture advance speed controls how quickly the vertical scan lines move across the screen. A fast advance speed expands the size of a school of fish horizontally on the screen. A slow advance speed shortens the school of fish. Use a fast advance speed to see the hard bottom. Use a slow advance speed to see the smooth bottom.

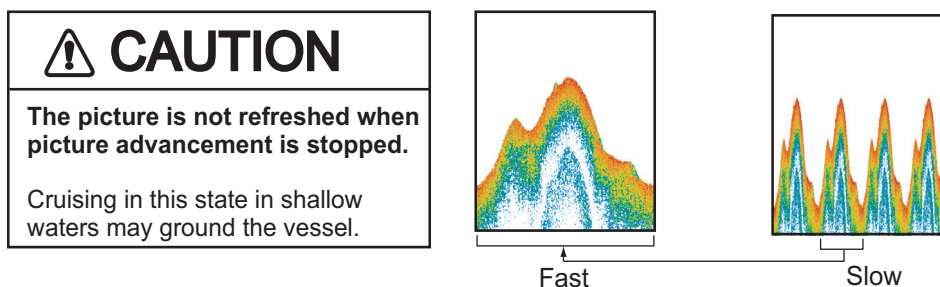

Note: The picture advances slightly slower when using ACCU-FISH™ or the bottom discrimination feature.

1. Open the Home screen, then tap [Settings]→[Fish Finder].
2. Tap [Picture Advance].
3. Tap a picture advance speed. [1/16] is the slowest advance speed (16 transmissions per one image feed) and [4] is the fastest speed (4 transmissions per one image feed). [Stop] stops picture advance, and is useful for taking a photo of the screen.
4. Tap the close button on the title bar to finish.

Picture advance speed can also be set from the Layers menu.

7.8 How to Reduce Interference

Interference from other fish finders and electrical equipment appears on the screen as shown in the illustration. When these types of interference appear on the screen, use the interference rejector to reduce the interference. Turn off the interference rejector when there is no interference, so that you do not erase weak echoes.

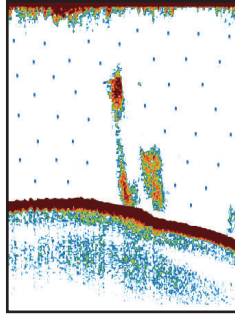

Interference from other sounder

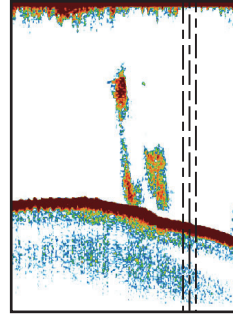

Interference from electrical equipment

1. Open the Home screen, then tap [Settings]→[Fish Finder].
2. At Turn [Interference Rejection], tap [Low], [Medium], [High] or [Auto]. [High] provides the greatest interference rejection. [Auto] automatically selects suitable interference setting. [Off] disables the interference rejector.

Note: If two sounders (especially, CHIRP transducer) in the network are used simultaneously, refer to the table below for interference rejector setting information.

	Unit	Interference rejector setting
	Other CHIRP sounder	Set to [Medium] or [High].
	DFF-3D	If the DFF-3D and the internal sounder are set to [High], the interference rejector can be adjusted from the internal sounder, from the Layers menu.

3. Tap the close button on the title bar to finish.

The interference rejector can also be set from the Layers menu.

7.9 How to Erase Unnecessary Echoes

You can erase unnecessary echoes that fill the entire screen. Weaker echoes are erased sequentially to show only strong echoes and clear the picture.

1. Open the Home screen, then tap [Settings]→[Fish Finder].
2. Operate the slider bar of [Color Erase] to set the level of echo erasure. Echoes are erased in sequential strength.
3. Tap the close button on the title bar to finish.

The [Color Erase] function can also be set from the Layers menu.

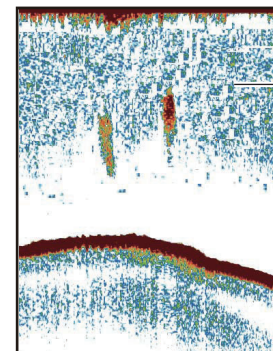

Weak echoes

7.10 How to Measure Range, Depth to an Object

You can measure the range and depth from the fish finder transducer to an object (school of fish, reef, etc.) with the VRM.

To display the VRM, tap an object. Read the range and depth to the object in the pop-up menu.

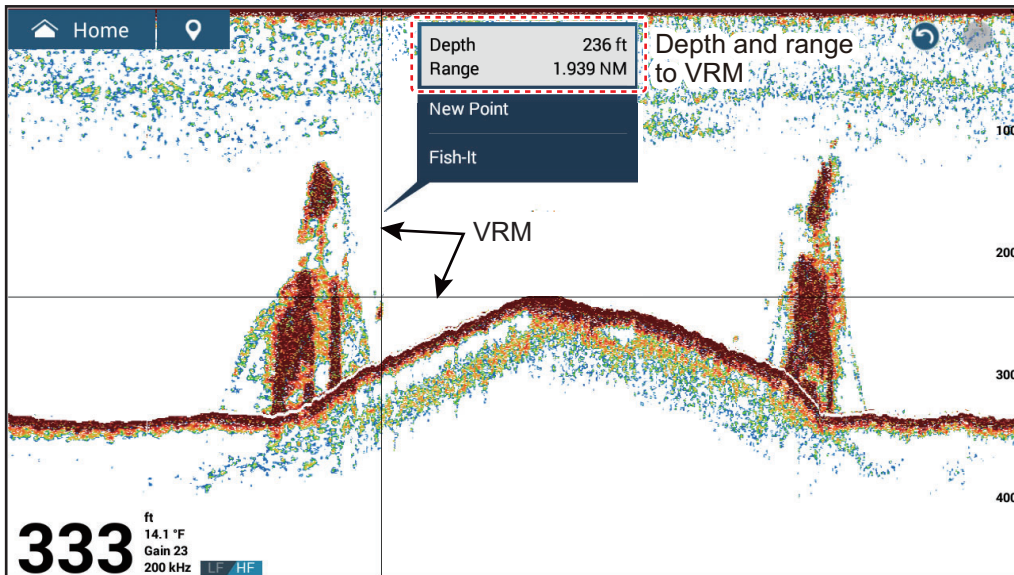

7.11 Echo History Display

You can view past echoes which are off the screen. Swipe the screen to the right to display past echoes. To return to the active display, tap [Cancel Hist] at the top right-hand corner of the screen.

7.12 How to Balance Echo Strength

Depending on local ultrasound characteristics, the reflection from a school of fish in deep water may appear in weaker colors than that from a school in shallow water even though their strengths are equal. To show the schools of fish in equal strengths (colors), use the TVG. The gain level is adjusted according to TVG level and TVG distance*, so that echoes of the same strength are displayed in the same colors.

* DFF-3D only.

Note: This function is not available in the auto mode.

The figure shows an example display with proper TVG setting.

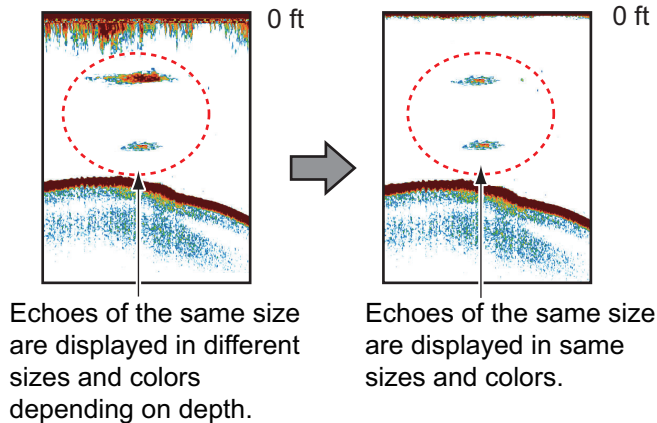

1. Open the Home screen, then tap [Settings]→[Fish Finder].
2. Drag the slider in [TVG HF] (or [TVG MF], [TVG LF]) to set the level. The TVG's function changes according to the fish finder model used, as shown in the table below.

Fish finder	TVG setting method
DFF1, DFF1-UHD, BBDS1, DFF-3D (version 1.04 or earlier)	The higher the setting, the greater the sensitivity at close ranges.
Internal sounder (TZT9F, TZT12F, TZT16F, TZT19F), DFF3. DFF-3D (version 1.05 or later)	The higher the setting, the lower the sensitivity at close ranges.

3. Tap the close button on the title bar to finish.

The TVG can also be set from the Layers menu.

7.13 Fish Finder Alarms

Two types of fish alarms release audio and visual alarms to tell you that echoes from fish are in the area you selected. These alarms are [Fish Alarm] and [Fish Alarm for Bottom Lock].

The [Fish Alarm] function tells you when an echo above some strength (selectable) is within the alarm range you specify.

The [Fish Alarm for Bottom Lock] function tells you when fish are within some distance from the bottom. The bottom lock display must be active to use this alarm.

7.13.1 How to set an alarm

1. Open the Home screen, then tap [Settings]→[Fish Finder]. Scroll the menu to show the [FISH FINDER ALARMS] section.
2. **[Fish Alarm]:** Tap [Range Minimum Value] or [Range Maximum Value] below [Fish Alarm] to display the software keyboard.
[Fish Alarm for Bottom Lock]: Tap [Range Minimum Value] or [Range Maximum Value] below [Fish Alarm for Bottom Lock] to display the software keyboard.

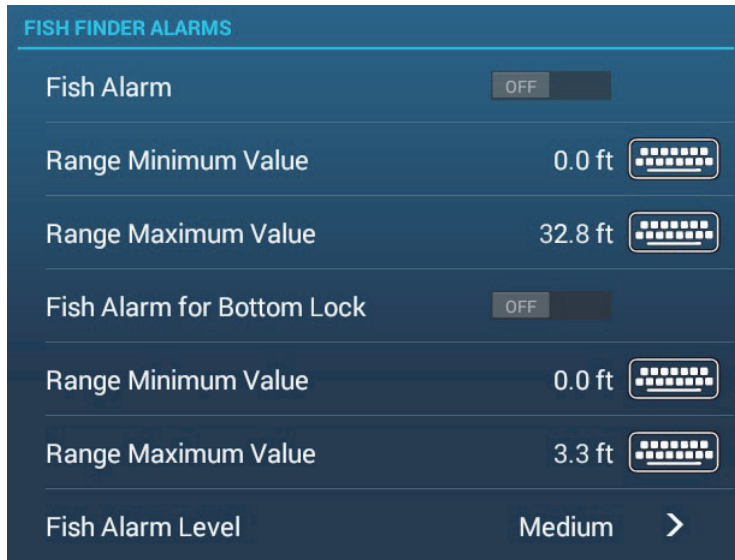

3. Set the start depth in [Range Minimum Value], the end depth in [Range Maximum Value].

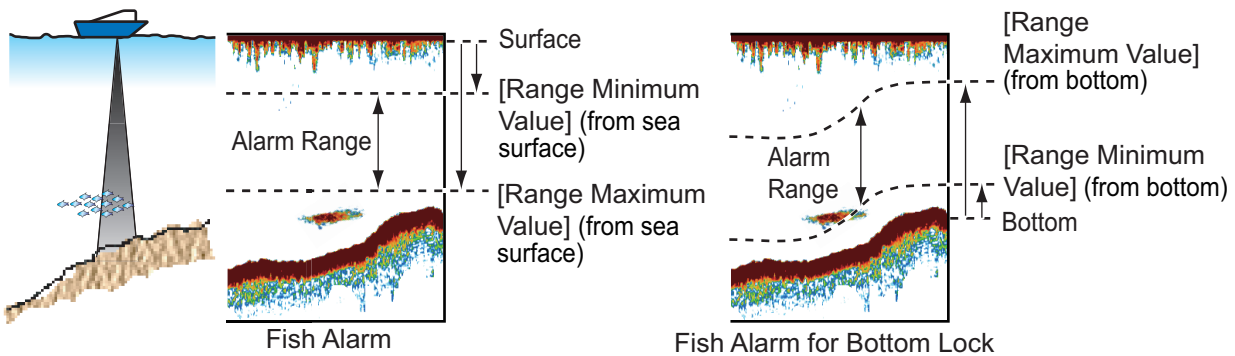

4. Tap the close button on the title bar to finish.

7.13.2 How to activate or deactivate an alarm

Fish alarm

1. Open the Home screen, then tap [Settings]→[Fish Finder].
2. Turn [Fish Alarm] on or off.
3. Tap the close button on the title bar to finish.

The fish alarm can also be activated or deactivated with [Fish Alarm] on the pop-up menu.

Bottom lock fish alarm

1. Open the Home screen, then tap [Settings]→[Fish Finder].
2. Turn [Fish Alarm for Bottom Lock] on or off.
3. Tap the close button on the title bar to finish.

Open the Home screen, then tap [Settings]→[Fish Finder]. Turn [Fish Alarm for Bottom Lock] on or off.

7.13.3 Alarm sensitivity

You can select the echo strength that releases the fish alarms.

1. Open the Home screen, then tap [Settings]→[Fish Finder].
2. Tap [Fish Alarm Level].
3. Tap which echo strength releases the fish and bottom lock alarms. Low releases the alarm against weak-to-strong echoes.
4. Tap the close button on the title bar to finish.

7.14 ACCU-FISH™

The ACCU-FISH™ feature, which requires an ACCU-FISH™ capable transducer (see Appendix 3 for compatible transducers), Bottom Discrimination Sounder BBDS1 or Network Fish Finder DFF series, calculates the length of each fish and shows a fish symbol and depth value or fish length.





Usage guidelines

- The information provided by this feature is intended for reference only. It does not indicate the exact length of a fish.
- ACCU-FISH™ is available for use on both the high and low frequencies.
- The intensity of an echo depends on fish species. If the indicated length is different from the true length, you can apply an offset. See section 7.14.2.
- Two frequencies are transmitted alternately without reference to the current display mode.
- Use this feature with ship speed of 10 knots or less and depth between 2 and 100 m.
- This feature cannot be used with the inside-hull transducer since a fish may not be detected depending on the frequency of the transducer. Even if a fish is detected, the fish length indicated may be smaller than the actual length.
- ACCU-FISH™ uses both low and high frequency echoes for the measurements regardless of the frequency mode in use.
- Echoes from a school of fish can be in more than one layer, which can cause wrong length indication.
- The fish symbol indication is not shown when the bottom echo is not shown on the screen.
- The split range feature is inoperative when ACCU-FISH™ is on.

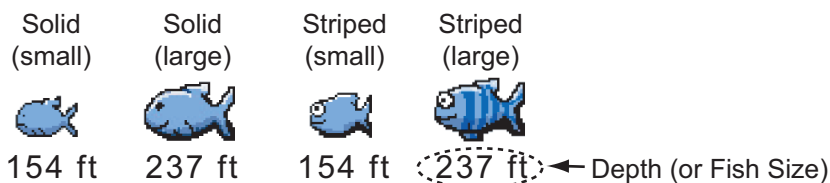
7.14.1 How to set ACCU-FISH™

1. Open the Home screen, then tap [Settings] → [Fish Finder].
2. Tap [ACCU-FISH Info].
3. Tap [Fish Size] or [Depth]. Tap [<] on the title bar to go back one layer in the menu.
[Fish Size]: Show length of fish.
[Depth]: Show depth of fish.
4. Tap [ACCU-FISH Symbols].
5. Tap [Solid], [Striped] or [Off] (turn off fish symbol).



Fish size	Solid	Striped
Large fish symbol (more than 51 cm (20.08 inch))		
Small fish symbol (10 to 50 cm (3.9. to 19.69 inch))		

6. Tap the close button on the title bar to finish.

7.14.2 Fish size correction

The fish size shown on the screen can be different from the true size. If the size is wrong, add an offset to the measured value to get a more accurate indication on the screen.

1. Open the Home screen, then tap [Settings]→[Fish Finder].
2. Drag the slider at [ACCU-FISH Size Correction] to set correction percentage (setting range: -80% to 100%).

Setting	Revised size	Setting	Revised size
+100	Two times	-65	1/3
+50	1.5 times	-75	1/4
-50	1/2	-80	1/5

3. Tap the close button on the title bar to finish.

7.14.3 How to turn the fish symbol indication on or off

Tap the screen to open the pop-up menu. Turn [ACCU-FISH] on or off. Fish symbols and their depth values or fish lengths appear on the screen. If you selected [Off] at step 5 in subsection 7.14.1, the fish symbols are hidden and only the depth values or fish lengths appear.

Note: The ACCU-FISH icon is always OFF on the weather display.

7.14.4 How to display the fish information

Tap a fish symbol to display the information (size, depth, bearing and range) about the fish.

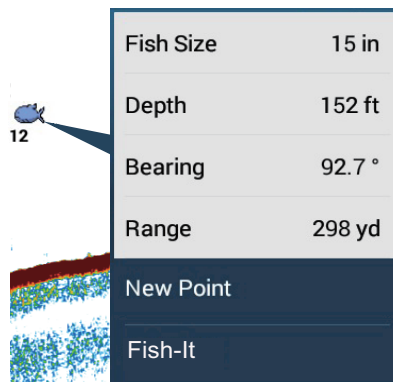

7.14.5 How to set the minimum size of ACCU-FISH™ symbols

If you are in an area where there are many fish, the screen may become congested with ACCU-FISH™ symbols. To prevent this, you can set the minimum size for the symbols.

1. Open the [Fish Finder] menu.
2. Tap [ACCU-FISH Minimum Size] to show the software keyboard.
3. Enter the minimum size (0 to 79.98 (inch)), then tap ✓.
4. Tap the close button on the title bar to finish.

7.15 RezBoost™

With connection of a RezBoost™ capable transducer, echo resolution can be improved. In the example below, it is difficult to distinguish fish from the bottom. With [Enhanced] RezBoost™, however, fish near the bottom are clearly seen.

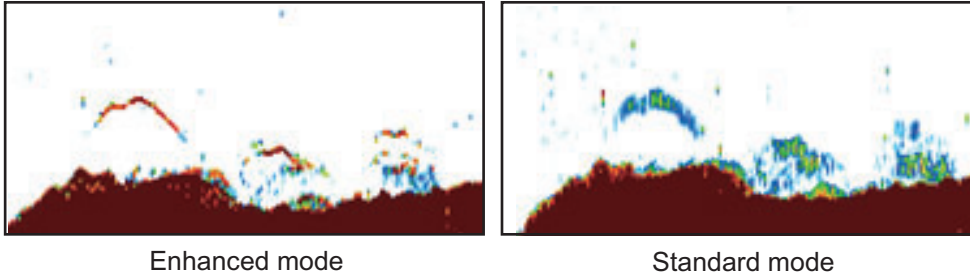

Enhanced mode

Standard mode

RezBoost™ is available with the transducers listed in Appendix 3.

Note: To enable RezBoost™, set the fish finder source as [TZT9F], [TZ12F], [TZT16F] or [TZT19F] as applicable.

1. Open the Layers menu.
2. Set [RezBoost] to [Enhanced].

To deactivate RezBoost, select [Standard] at step 2 in the procedure.

7.16 White Edge

The white edge function gives the seabed echo a white edge, making it easier to differentiate bottom-feeding fish from the seabed itself.

Note 1: The white edge function is compatible with the internal fish finder, as well as the following transducers and their software versions. Use of other transducers or software versions is not recommended.

Transducer	Software version
BBDS1	0252379-02.01, or later
DFF1	0252353-03.01, or later
DFF1-UHD	0252405-03.01, or later
DFF3	0252362-02.01, or later
DFF-3D	0252440-01.03, or later

Note 2: White edge is not available when a TZT9, TZT14 or TZTBB is connected in the same network.

To activate the white edge function, do the following:

1. Open the Layers menu.
2. At [White Edge], tap the desired width for the white edge. The higher the number the greater the width.

To deactivate the white edge function, tap [Off] at step 2 in this procedure.

Note: With the DFF-3D's triple beam display, white edge is available only with the downward picture.

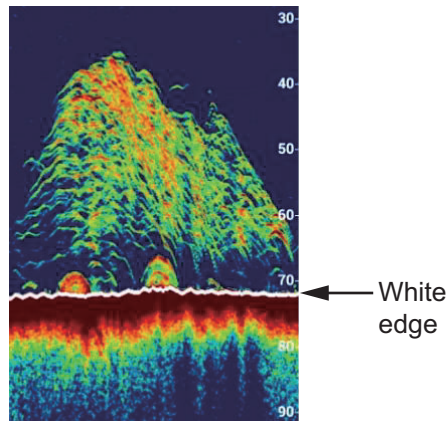

7.17 Water Temperature Graph

With connection of a water temperature sensor, you can plot sea surface temperature over time. Open the Layers menu and turn on [Temperature Graph]. The sea surface temperature graph runs across the screen from right to left, the latest temperature at the right edge. The temperature scale is at the left edge of the display. The unit of measurement ($^{\circ}\text{C}$ or $^{\circ}\text{F}$) can be selected with [Temperature] in the [Units] menu.

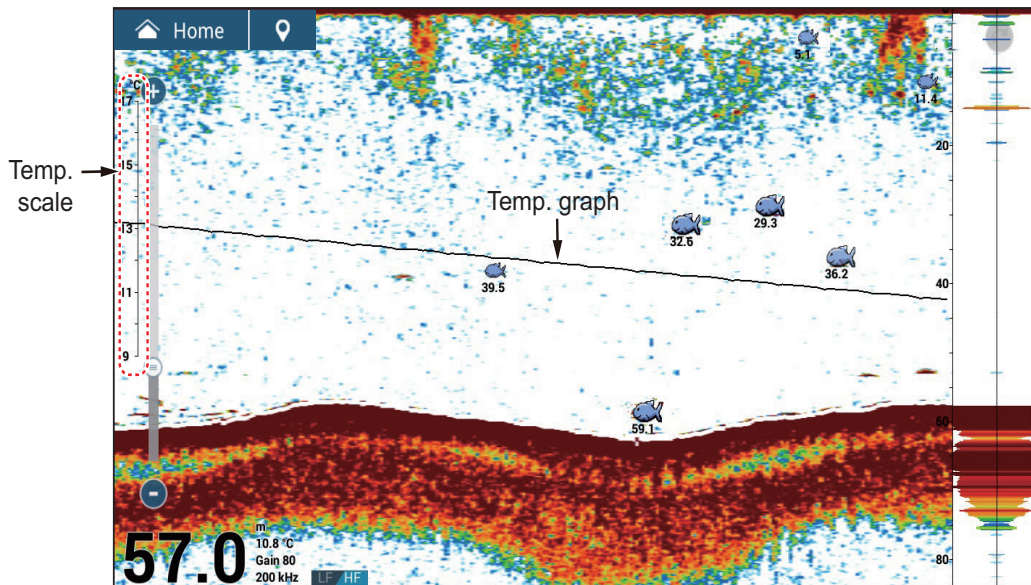

7.18 Preset Frequency

The optional fish finder power amp DI-FFAMP (TZT12F/TZT16F/TZT19F) lets you preset three distinct frequencies when using the internal fish finder.

Note 1: The DI-FFAMP does not support the bottom discrimination display, ACCU-FISH™ or RezBoost™.

Note 2: The present frequency function is only available when the transducer is selected by model or TDID ([Fish Finder]→[Transducer Setup]→[Transducer Setup Type]→[Model] or [TDID]). See the Installation Manual for details.

1. Open the [Fish Finder] menu.
2. Tap [Preset Frequency Setup].

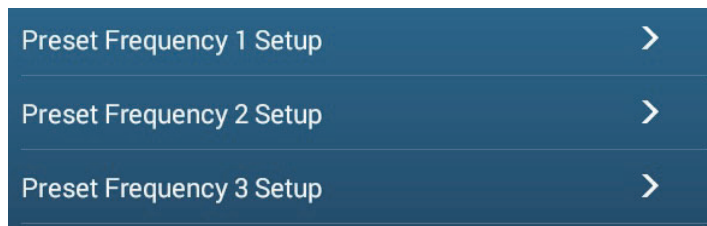

3. Tap [Preset Frequency 1 Setup] (or 2, 3).

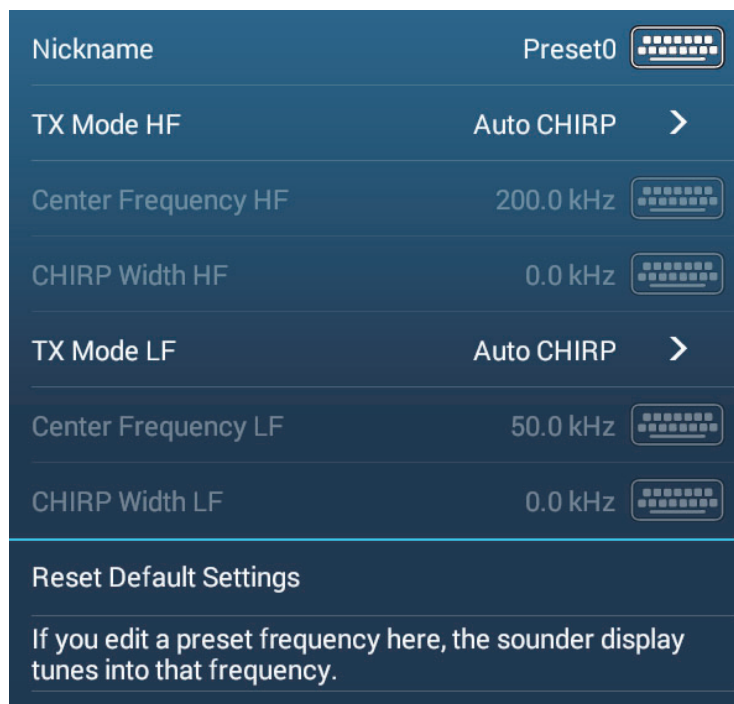

4. Tap [Nickname]. The software keyboard appears.
5. Change the nickname, then tap [✓].
6. Tap [TX Mode HF] or [TX Mode LF]

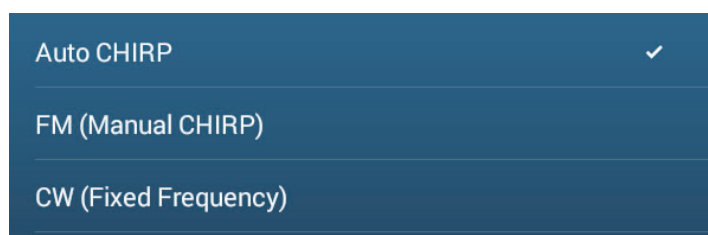

7. Select [Auto], [FM (Manual CHIRP)], or [CW (Fixed Frequency)] as appropriate. [Auto] automatically adjusts CHIRP center frequency and frequency bandwidth according to the depth. For [Auto], go to step 12. For [FM (Manual CHIRP)] or [CW (Fixed Frequency)] go to step 8.
8. Tap [Center Frequency HF] or [Center Frequency LF] to show the software keyboard.
9. Set the center frequency, then tap [✓]. For [FM (Manual CHIRP)] go to step 10. For [CW (Fixed Frequency)] go to step 12.
10. Tap [Chirp Width HF] or [Chirp Width LF] to show the software keyboard.
11. Set the chirp frequency bandwidth, then tap [✓].
Note: A new frequency is applied after changing it and returning to the fish finder display.
12. Tap the close button on the title bar to finish.

You can switch the frequencies from the Layers menu; tap [Preset 0] (1 or 2) at [Preset Frequencies].

For other, related menu settings, see section 7.19.

7.19 Fish Finder Menu

This section describes the fish finder functions not described in previous sections. Open the Home screen, then tap [Settings]→[Fish Finder] to show the menu.



[Fish Finder Source]: Set the fish finder to use (TZT9F, TZT12F, TZT16F, TZT19F, BBDS1, DFF1, DFF3, DFF1-UHD). When using the built-in fish finder, select [TZT9F], [TZT12F], [TZT16F] or [TZT19F] as applicable. You can switch the fish finder source with [Fish Finder Source] in the [FISH FINDER INITIAL SETUP] section.

[Day Background Color]: Select the background color for use during daylight hours. The options are [White], [Light Blue], [Black], [Dark Blue], and [Blue].

[Night Background Color]: Select the background color for use at nighttime. The options are [Black], [Dark Blue], and [Blue].

[Echo Color Levels]: Select the number of colors shown on the screen. The selections are [8 Colors], [16 Colors] and [64 Colors].

[Cancel Smoothing]: When you select [OFF], smoothed echoes are displayed, however, the screen resolution is lower. To get higher screen resolution and greater detail, select [ON].

[Bottom Search Mode]: This function eliminates the timing of acquiring echoes from the bottom, in order to improve the fish finder performance in the water layer. When turned ON, transmission is turned off once every three transmissions to check the water depth and eliminate false echoes. When turned off, transmission is not turned off, so the transmission cycle is 1.5 times faster. This is convenient for offshore lure fishing. You can also set this item from the Layers menu.

[Bottom Range Shift Area]: Select the area where to show the bottom echo, when [Auto Range] is active. For example, setting 75% would place the bottom echo at a position equivalent to 75% from the top of the screen.

[Heaving Correction]: Turn to apply heaving correction, to stabilize the picture in heavy seas.

Note: [Heaving Correction] requires connection of a Satellite Compass™ and motion sensor configuration (see section 3.5 of the Installation Manual). This function is inoperative without a Satellite Compass™.

[Transmit Rate Mode]: Select the transmission rate selection method. [Auto] sets the rate according to ship's speed. Select [Manual] to set the rate manually.

[Transmit Rate Manual]: Change the TX pulse repetition rate in 21 levels (21 is highest power.). Use 20 in normal use. Lower the TX rate in shallow waters to prevent the second reflection echo.

[Fish Finder Transmit]: Turn sounder transmission on or off.

Fish Finder initial setup

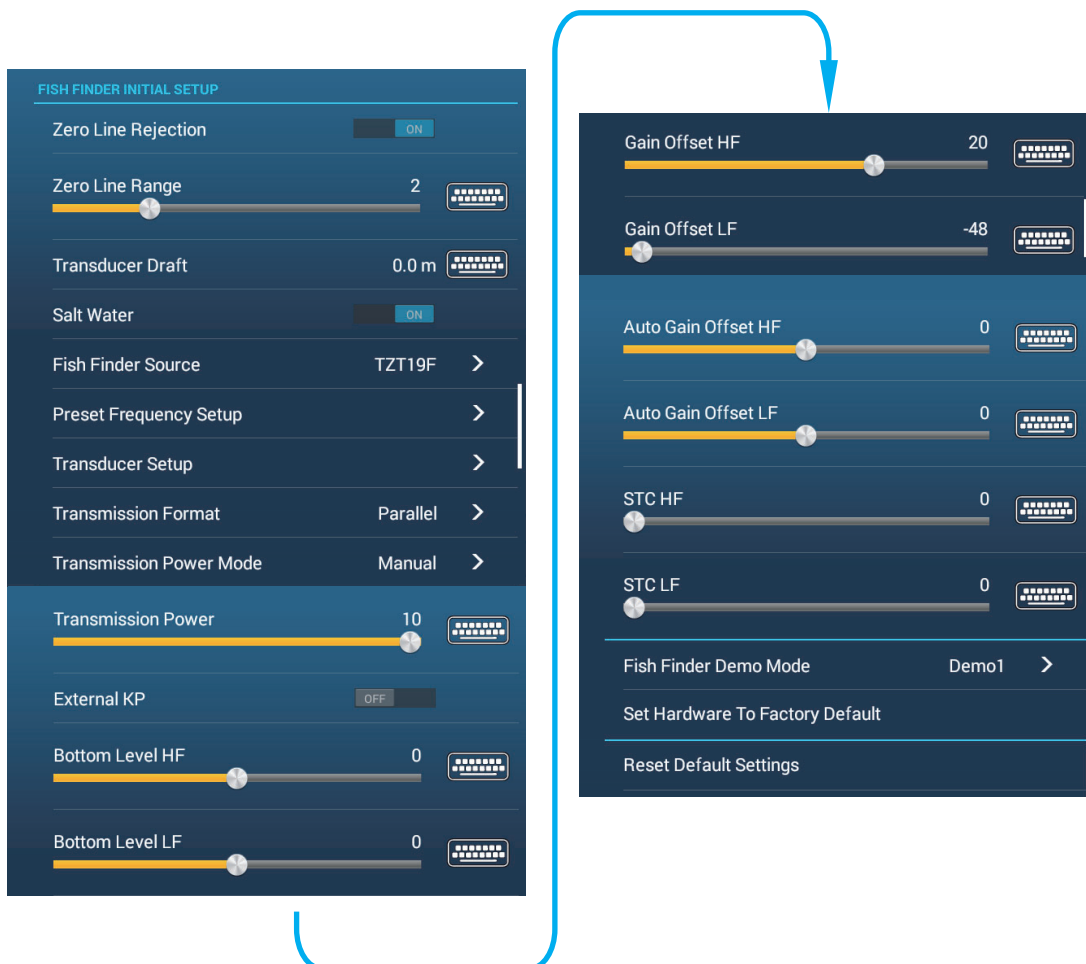

[Zero Line Rejection]: Turn the zero line (transmission line) on or off. When turned on, the transmission line disappears, which allows you to better watch fish echoes near the surface. The length of the transmission line changes with transducer used and installation characteristics.

Note: If the sounder source is [DFF3], adjust [Zero Line Range] (below) to set the area where to reject the zero line.

7. FISH FINDER (SOUNDER)

[Zero Line Range]: This feature adjusts the transmission line so that the transmission line disappears when the menu item [Zero Line Rejector] is turned on. Available with DFF3 and DI-FFAMP. The setting range is 1.4 to 2.5 for DFF3; 1.4 to 3.8 For DI-FFAMP. For a long tail, increase the value. If the transmission line does not disappear, lower the TX power. Applicable to Network Sounder DFF3.

[Transducer Draft]: Set the distance between the transducer and the draft line to show the distance from the sea surface (Setting range: 0.0 to 99.9 ft).

[Salt Water]: Select [ON] to use this equipment in salt water.

[Fish Finder Source]: Select the fish finder used.

[Transducer Setup]: Select the method to setup the transducer, by model, manually, or TDID (transducer ID). See the installation manual for details.

[Transmission Format]: Select whether to transmit high frequency and low frequency simultaneously or with a time difference (DI-FFAMP exclusive menu item). [Parallel] transmits the frequency simultaneously. [Sequential] transmits with a delay between transmissions. Use [Sequential] if [Parallel] is generating interference.

[Transmission Power]: Interference can appear on the screen when the fish finder on your ship and one on another ship have the same TX frequency. To prevent this interference, lower your TX power and ask the other ship to lower their TX power. For the DI-FFAMP, the setting range is 0 (off) to 10. For the DFF1-UHD the settings are "minimum" and "maximum".

[External KP]: Turn on to sync with external keying pulse. The default setting uses the internal sync pulse. For external keying pulse synchronization, set this item to [ON].

[Bottom Level HF (MF, LF)]: The default bottom level setting (0) determines that two strong echoes received in sequence are bottom echoes. If the depth indication is not stable in the default setting, adjust the bottom level here. The setting range is -40 to 40. If vertical bars appear on the bottom line in the bottom expansion display, lower the bottom level until the vertical bars disappear. Be careful not to lower the level excessively; bottom fish may be judged as the bottom echo.

[Gain Offset HF (MF, LF)]: If the gain setting is wrong, or there is a difference in the gain between the low and high frequencies, you can balance the gain for the two frequencies here.

[Auto Gain Offset HF (MF, LF)]: If the auto gain offset is wrong, or there is a difference in the gain between the low and high frequencies, set an offset here to balance auto gain for the two frequencies. Auto adjustment of gain offset can also be done from the Layers menu.

[STC HF (MF, LF)]: Delete unnecessary echoes (plankton, air bubbles, etc.) near the surface that hide the fish near the surface. The setting range is 0 to 10, and 0 is off. 10 deletes unnecessary echoes from the surface to approximately 16 ft. Make sure you do not use more STC than necessary, because you can erase the small echoes near the surface. (For DFF3, DFF1-UHD)

[Frequency Adjust HF (MF, LF)]: You can adjust the TX frequency of both the low- and high-frequency transducers. Use this feature when your fish finder and another fish finder operate on the same frequency, causing interference. Change the frequency of your transducer by enough percentage points to remove the interference. (For DFF3)

[TX Pulse HF (MF, LF)]: The pulse length is automatically set according to range and shift. Use a short pulse for better resolution and a long pulse when detection range is important. To improve resolution on zoom displays, use [Short 1] or [Short 2]. [Short 1] improves the detection resolution, but the detection range is shorter than with [Std] (pulse length is 1/4 of [Std]). [Short 2] raises the detection resolution, however detection range is shorter (pulse length is about 1/2 of [Std]) than [Std]. [Std] is the standard pulse length, and is suitable for general use. [Long] increases the detection range but lowers the resolution (about 1/2 compared to the [Std] pulse length). (For DFF3, DI-FFAMP)

[Rx Band HF (MF, LF)]: The RX bandwidth is automatically set according to pulse length. To decrease noise, select [Narrow]. For better resolution, select [Wide]. (For DFF3)

[Temperature Port]: Select the data source for water temperature (For DFF3, DFF1-UHD).

[MJ]: The water temperature data from the water temperature/speed sensor.

[Low Frequency]: The low frequency measured water temperature.

[High Frequency]: The high frequency measured water temperature.

[Fish Finder Demo Mode]: Activates, deactivates the fish finder demo mode, which provides a fish finder display with data stored in the memory. Connection of the transducer is not required. Requires connection to the internal fish finder, DFF1, BBDS1, DFF3, DFF1-UHD, or DI-FFAMP.

[Off]: Disables the fish finder demo display.

[Set Hardware to Factory Default]: Select this menu item to restore default settings for the unit selected in [Fish Finder Source] (excludes TZTL12F/15F and TZT2BB).

[Reset Default Settings]: Select this menu item to restore default settings for the [Fish Finder] menu.

7.20 Interpreting the Display

Zero line

The zero line (transmission line) shows the position of the transducer. The line disappears from the screen when the range is shifted.

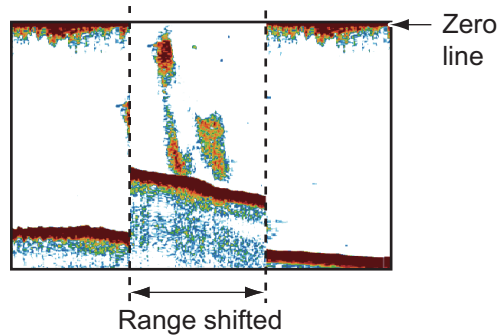

Bottom echoes

The strongest echoes are from the bottom, and are normally shown in reddish-brown or red. The colors and the width change with bottom material, depth, sea condition, installation, frequency, pulse length and sensitivity.

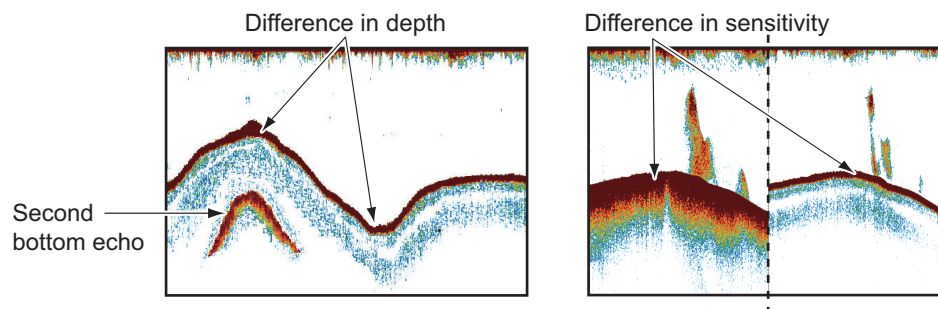

Bottom contour

The tail from a hard bottom is longer than the tail from a soft bottom, because the hard bottom reflects more of the ultrasonic pulse. An echo from shallow water gives a stronger reflection than the echo received from deep water. A longer bottom tail appears on slopes, because of the difference in travel time at both edges of the beam angle. For the rough bottom, echoes are reflected on many different planes, which displays echoes in many layers, giving a 3D effect.

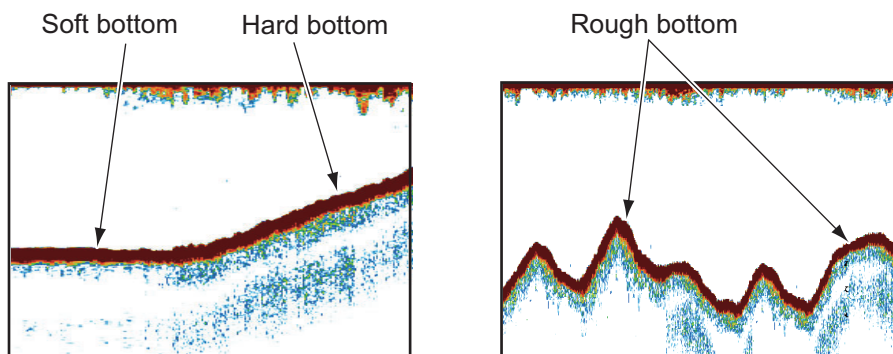

Nature of a bottom

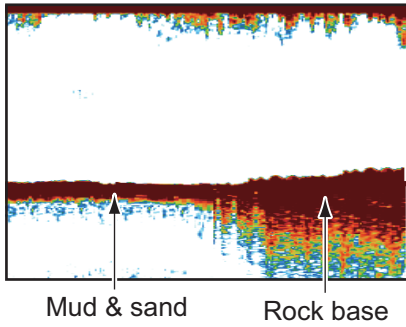

The nature of a bottom is known from the intensity and length of the bottom tail. To find the nature of a bottom, use a long pulse length and normal gain. For the hard and rough bottom, the bottom echo is reddish-brown with a long tail. For the mud or sand bottom, the bottom echo has less red and with a short tail. A bottom with a lot of small particles can give a long tail on the low frequency picture.

Fish volume

The size and density of a school of fish are indicators of the quantity of fish.

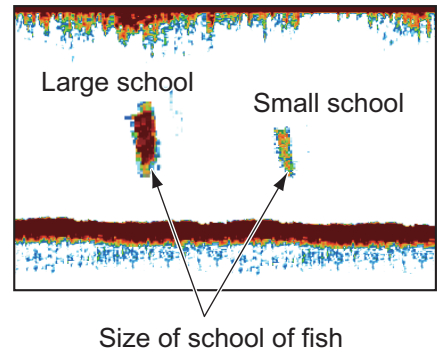

Size of a school of fish

Usually the size of fish echoes on the screen is proportional to the actual size of the school of fish. However, if two fish echoes appear at different depths with the same size, the school of fish at the shallower depth is larger because the ultrasonic beam widens as it propagates and a school of fish in deep water is displayed larger.

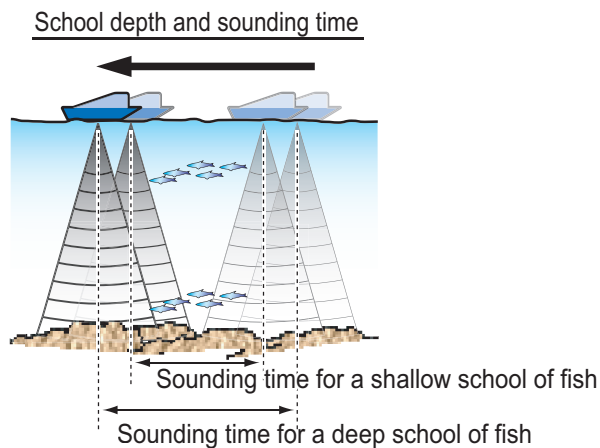

7. FISH FINDER (SOUNDER)

Density of a school of fish

If two schools appear with the same color at different depths, the one in deeper water is denser because the ultrasonic wave attenuates as it propagates and the school of fish in deep water tends to be displayed in a weaker color.

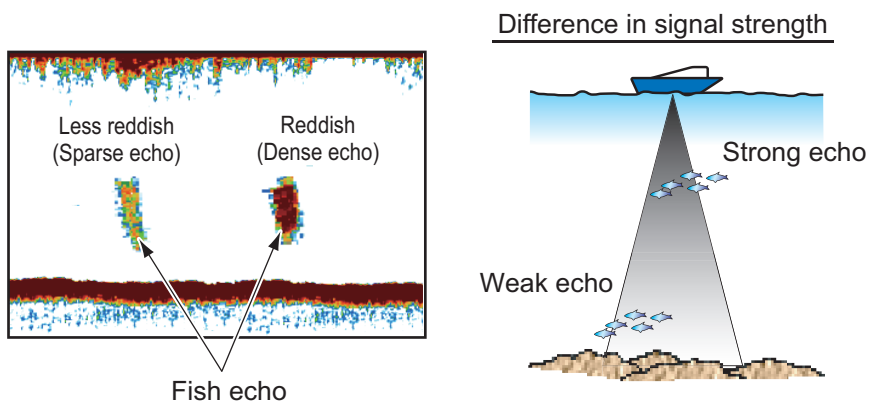

Bottom fish

The echoes from the bottom are stronger than the bottom fish echoes so that you can distinguish between them by colors. The bottom echoes are normally shown in reddish-brown or red, the bottom fish echoes in weaker color.

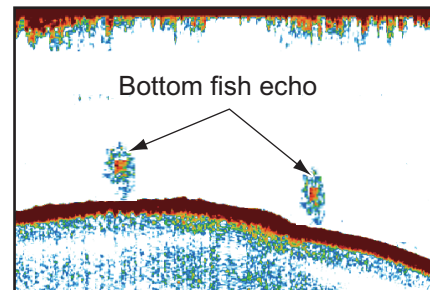

Plankton

Plankton, seen on the screen as a mass of green or blue dots, appears between the transmission line and the seabed. Plankton move down in the day and up at night. Because fish feed of the plankton, you can observe schools of fish within the plankton layer.

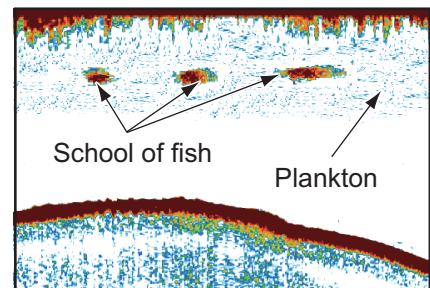

Current rip

When two ocean currents of different speeds directions and water temperatures meet, a current rip occurs. A current rip appears on the screen as shown in the right illustration.

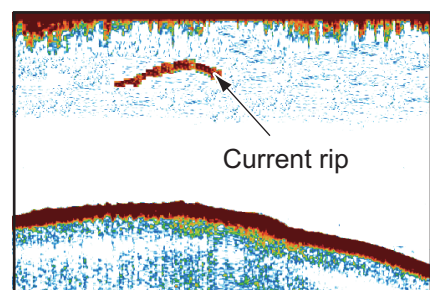

Surface noise

When the sea is rough or the ship moves over a wake, surface noise can appear at the top of the screen.

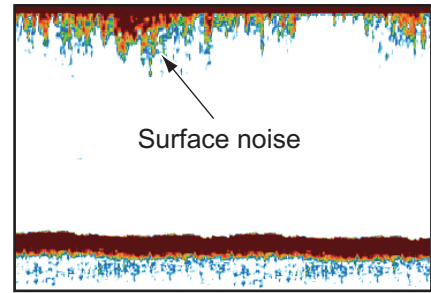

Air bubbles in the water

When the sea is rough or the ship makes a quick turn, there can be blank spots in the bottom echo (see the right illustration). These blank spots are caused by air bubbles which stop the movement of the sound wave. These air bubbles can occur with the low frequency ultrasonic waves.

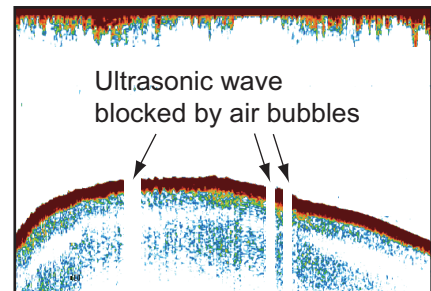

Unstable bottom echo

The bottom echoes can have a saw-tooth appearance. This occurs in heavy weather because pitching and rolling changes the direction of the ultrasonic pulses and the vertical motion of the ship causes the distance to the bottom to change.

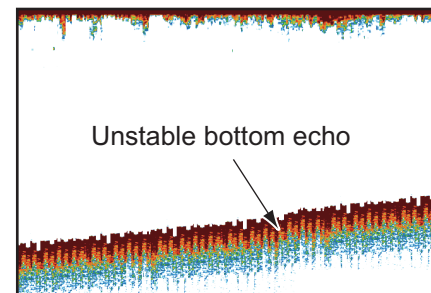

False echo

When an ultrasonic pulse is transmitted, some energy leaves from each side of the beam. This energy has the name "sidelobe". Echoes from sidelobes show on the screen as false images like in the illustration shown below.

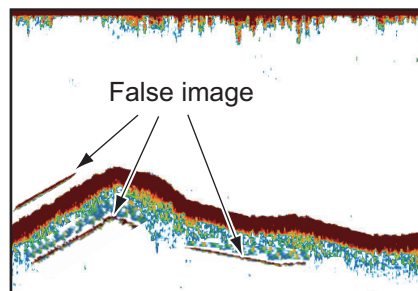
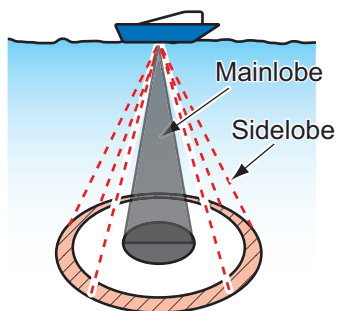

7. FISH FINDER (SOUNDER)

This page is intentionally left blank.

8. MULTI BEAM SONAR DFF-3D

This chapter describes the display screens (modes) available with the Multi Beam Sonar DFF-3D, which displays images of the underwater and the ocean floor with high precision. Four display screens are provided, multi-sounder, side scan, cross section, and 3D sounder history.

With connection of the DFF-3D, high resolution seafloor maps (PBG recordings) can be created and seen on the chart plotter display.

8.1 Menu Operations

This section covers the top layer of the [Multi Beam Sonar] menu. For details regarding menu operations with each of the displays, see the respective section.

Display	Section no.
Multi-Sounder	section 8.3
Side Scan	section 8.4
Cross Section	section 8.5
3D Sounder	section 8.6

8.1.1 How to start/stop transmission

You can start/stop transmissions from the multi-beam sonar by using the menu.

1. Open the Home screen, then tap [Settings]→[Multi Beam Sonar].
2. Tap the [Multi Beam Sonar Transmit] item to toggle between [OFF] and [ON].

8.1.2 How set the background color

You can set the background color for Day mode and Night mode to suit your preferences.

1. Open the Home screen, then tap [Settings]→[Multi Beam Sonar].
2. Tap [Day Background Color] or [Night Background Color] as required.

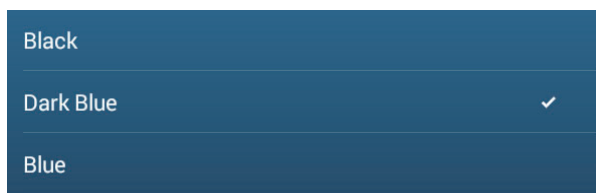

[Day Background Color] options

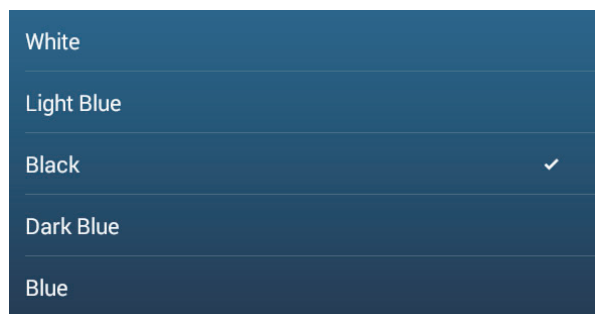

[Night Background Color] options

3. Tap the desired color.

8.1.3 How to adjust the bottom range shift

The bottom range shift feature changes the location at which the seabed appears on the screen. This is particularly useful when the seabed is “off-screen”.

Note: This feature requires [Auto Range] to be active. See your respective Operator’s Manual for details.

1. Open the Home screen, then tap [Settings]→[Multi Beam Sonar].
2. Slide the slide bar at [Bottom Range Shift Area] to adjust the value as required. The following figure shows some examples of how the settings affect the on-screen display.

A lower value places the seabed at a higher location on-screen. A higher value places the seabed at a lower location on-screen.

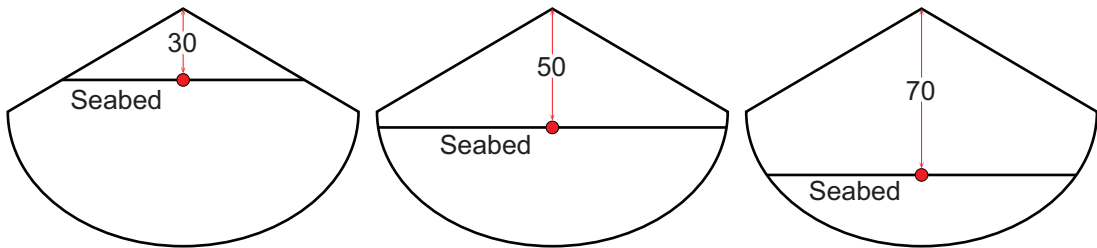

8.1.4 How to change the transmission rate

You can adjust the rate at which the sonar beam is transmitted using one of the three available settings. Each setting has distinct characteristics allowing for a broad range of applications.

Setting	Characteristics
[Manual]	Affected by the selected range. A shorter range has a faster transmission rate; a longer range has a slower rate.
[Auto]	Affected by vessel speed. Slow speeds have a slower transmission rate; high speeds have a faster rate. Note: Speeds of 20 kn or higher are fixed at a transmission rate of 20.
[Maximum]	Affected by detected depth. Shallows have a faster transmission rate; deeper waters have a slower rate. Note: Where the selected range exceeds the detected depth, the transmission rate may exceed 20.

1. Open the Home screen, then tap [Settings]→[Multi Beam Sonar].
2. Tap [Transmit Rate Mode].
3. Tap [Manual], [Auto] or [Maximum] as required.
4. If you selected [Manual], adjust the rate at [Transmit Rate Manual Value], using the slide-bar or the software keyboard. For [Auto] or [Maximum], go to step 4.

Note: Adjustments made to the transmission rate also affect how the on-screen display appears for the Multi-Sounder and 3D Sounder History features. The following figures show examples of the same object and how the echo display is affected.

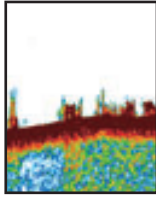
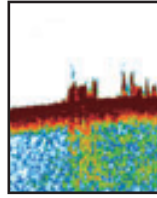
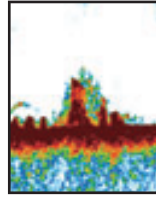
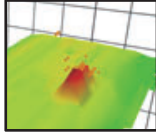
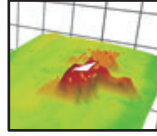
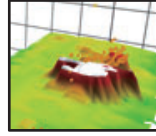
Display Screen	Rate = 0	Rate = 10	Rate = 20
Multi Sounder			
3D History			

8.2 Display Screens Overview

Multi-sounder display

From the home screen, tap the Multi Sounder icon to show the multi-sounder display.

The multi-sounder display operates similar to the conventional fish finder, providing information about the seabed and underwater conditions. The video display scrolls from the right to left with the passing of time.

The echoes appearing at the right edge of the display are the latest echoes. Echoes from individual fish, schools of fish and the seabed are shown. With the gain set properly, the distance to the seabed appears on the screen. Past echoes can be displayed.

The gain, clutter suppressor and TVG are adjusted according to the mode selected, auto fishing or auto cruising. Manual adjustment of those controls is also possible.

The single beam presentation displays the information detected by the downward-looking beam. The triple beam presentation displays the information detected by the port beam, starboard beam, and downward-looking beam.

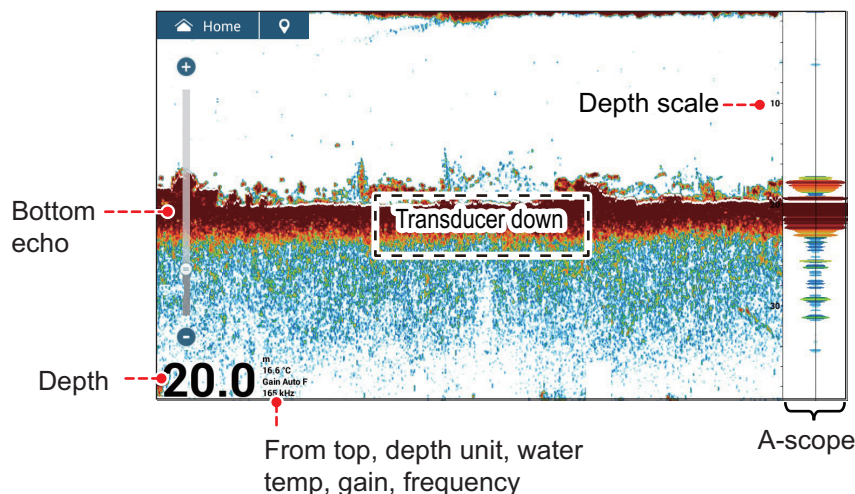

From top, depth unit, water temp, gain, frequency

Single beam display

8. MULTI BEAM SONAR DFF-3D

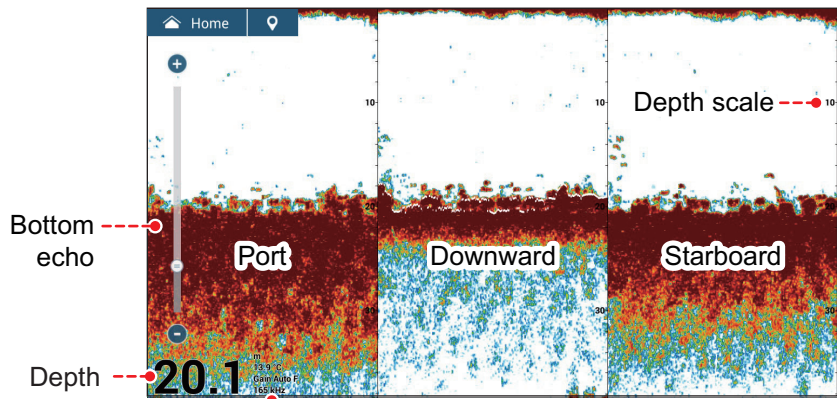

From top, depth unit, water temp, gain, frequency

Triple beam display

Side scan display

From the home screen, tap the Side Scan icon to show the side scan display.

The side scan display shows the echoes received from the port and starboard directions.

The side scan display starts from the center of the vessel, and traces in the port and starboard directions. The most recent echoes are at the top of the screen and the oldest are at the bottom of the screen.

The side scan display is different from the other modes employed by this equipment - it clearly displays the shape of echoes (fish bed, etc.).

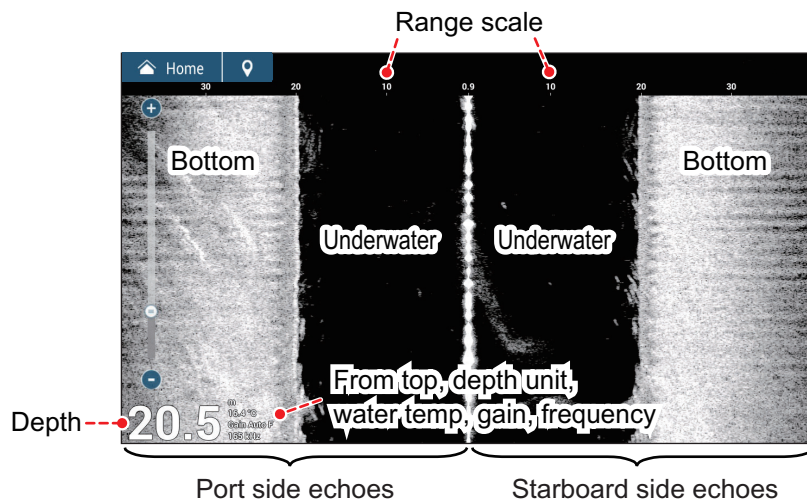

Side scan display

Cross section display

From the home screen, tap the Cross Section icon to show the cross section display.

The cross section display shows seabed and underwater conditions.

This multi beam sonar uses a 120° beam (downward to port 60°; downward to starboard 60°), providing highly accurate underwater images.

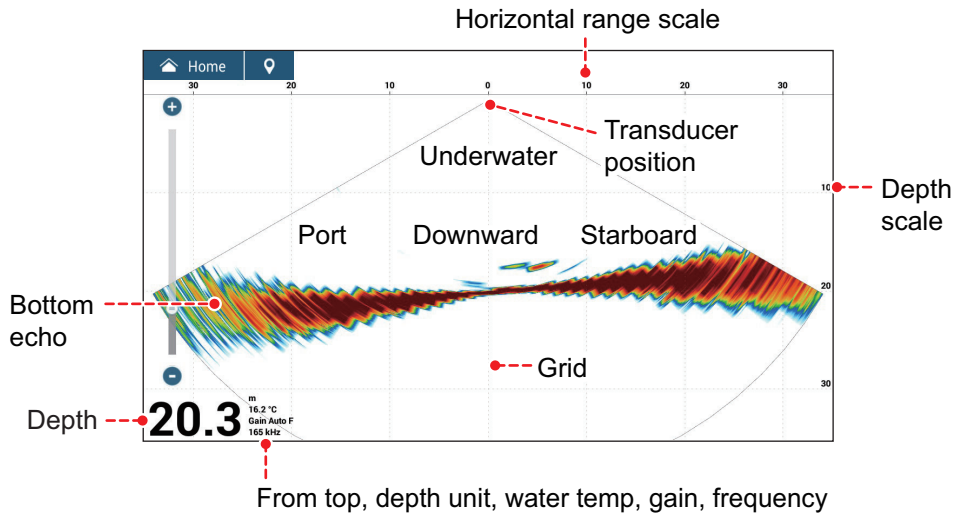
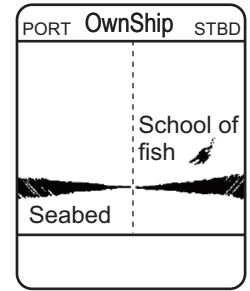
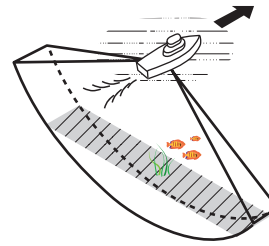

Cross section display

3D sounder history display

From the home screen, tap the 3D History icon to show the 3D sounder history display.

The 3D sounder history provides a 3D graphic of the past seabed and underwater echoes detected by your vessel. The display can be used to detect schools of fish.

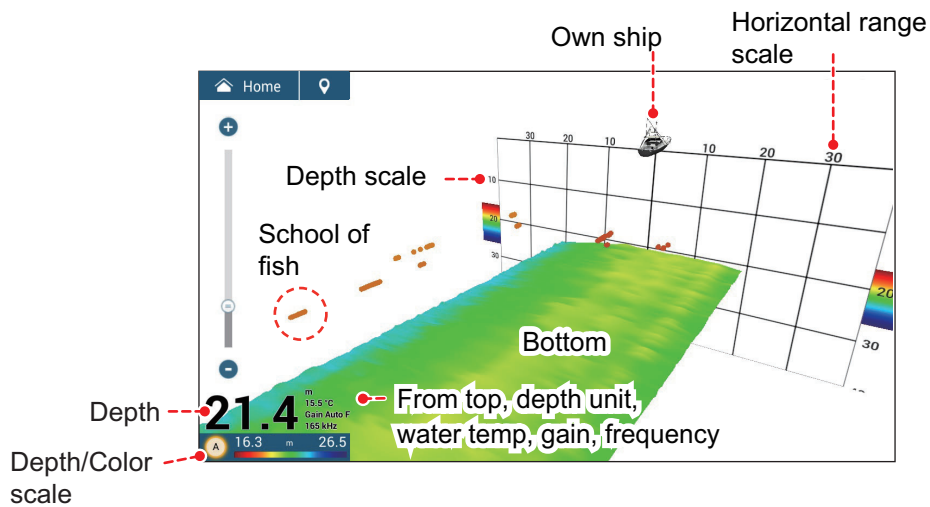

3D sounder history display

8.3 Multi-Sounder Display Operations

This section covers the functions available with the multi-sounder display. To show the [Multi-Sounder] menu, open the Layers menu and then tap [Multi-Sounder Settings]. The [Multi-Sounder] menu can also be accessed from the home screen: Tap [Settings]→[Multi Beam Sonar]→[Multi-Sounder].



Layers menu for multi-sounder

8.3.1 How to switch between TX and STBY

Open the Layers menu and then select [ON] for [TX/STBY] to start transmitting, [OFF] to stop transmitting. "Stand-by" appears at the center of the screen when transmission is stopped.

8.3.2 How to switch between single beam and triple beam presentations

1. Open the Layers menu.
2. Tap [Beam Mode].
3. Select [Single Beam] or [Triple Beam].

8.3.3 How to set the TX beam angle

You can set the TX beam angle for the port, starboard and downward beams.

1. Open the Layers menu.
2. Tap [Beam Angle].
3. Select the beam angle.

8.3.4 How to set the TX beam width

You can set the TX beam width for the port, starboard and downward beams.

1. Open the Layers menu.
2. Tap [Beam Width].
3. Select the beam width.

8.3.5 How to change the picture advance speed

The Picture Advance setting sets how quickly vertical scan lines move across the display. When viewing a seabed with sharp rises and falls, such as a reef-bed or submerged wreck, a fast advance speed helps to “smooth” out the seabed for easier viewing. On the other hand, when viewing a smooth seabed with little to no undulations, a slow advance speed helps to identify rises and falls.

Do the following to change the picture advance speed.

1. Open the Home screen, then tap [Settings]→[Multi Beam Sonar].
2. Tap [Multi-Sounder].
3. Tap [Picture Advance].
4. Select an advance speed to suit your requirements.
The default speed is [1/1] (normal speed), the fastest speed is [4/1] (four times normal speed) and the slowest speed is [1/8] (eight times slower than normal speed). Select [Stop] to stop the picture advance for closer examination and screenshots/photos.

The picture advance speed can also be changed from the Layers menu.

8.3.6 How to change the display mode

In addition to the normal multi beam sonar display, there is a “bottom zoom” display that enlarges and displays an image of a certain distance from the seabed, and a “bottom lock” display that enlarges and displays the area near the bottom. To switch the display mode, do the following:

1. Open the Layers menu.
2. At [Display Mode], tap [Full], [Bottom Zoom] or [Bottom Lock].

8.3.7 How to show or hide the depth and frequency indications

You can show or hide the depth and TX frequency at the bottom left corner of the screen.

1. Open the Layers menu.
2. Select [ON] or [OFF] for [Depth Information].

8.3.8 Availability of points and event marks registration, and go to a point

For operation, see chapter 4.

The table below shows function availability according to latitude/longitude, heading data presence or absence. If there is no latitude/longitude data, none of the functions below are available.

Latitude/Longitude / Heading data: YES

Item	Starboard	Downward	Port
Point registration	Yes	Yes	Yes
Go to point	Yes	Yes	Yes
Event mark registration	Yes	Yes	Yes

Latitude/Longitude: YES. Heading data: NO

Item	Starboard	Downward	Port
Point registration	No	Yes	No
Go to point	No	Yes	No
Event mark registration	No	Yes	No

For starboard, downward, and port, see the illustration "Triple beam display" on page 8-4.

8.4 Side Scan Display Operations

This section covers the functions available with the side scan display. For the menu items shared with the conventional fish finder, see chapter 7. To show the [Side Scan] menu, open the Layers menu and then tap [Side Scan Settings]; or from the home screen, tap [Settings]→[Multi Beam Sonar]→[Side Scan].

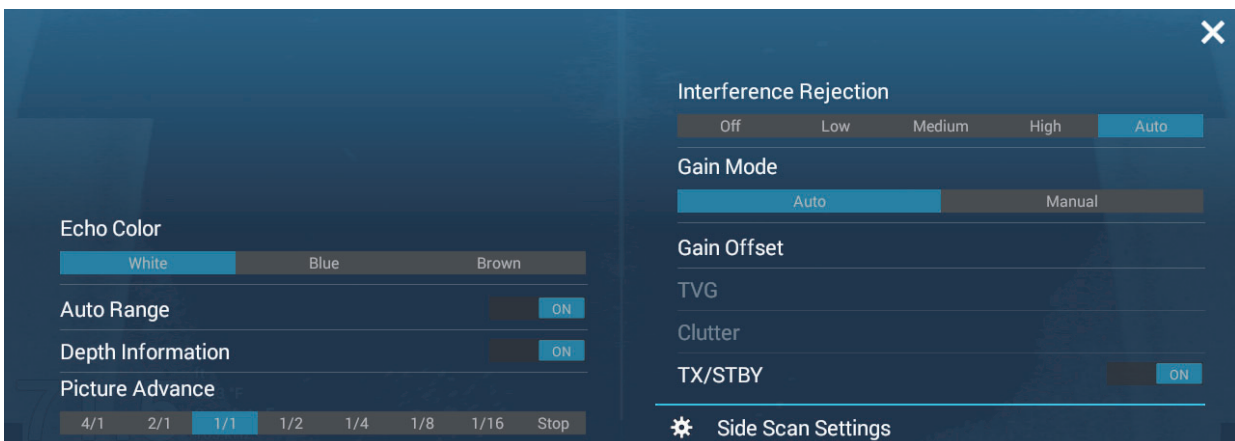

Layers menu for side scan

8.4.1 How to switch between TX and STBY

Open the Layers menu and then select [ON] for [TX/STBY] to start transmitting, [OFF] to stop transmitting. "Stand-by" appears at the center of the screen when transmission is stopped.

8.4.2 How to change echo color

You can select the echo color.

1. Open the [Side Scan] menu.
2. Tap [Echo Color].
3. Select [White], [Blue] or [Brown].
4. Tap the close button on the title bar to finish.

You can select the echo color from the Layers menu.

8.4.3 How to show or hide the depth and frequency indications

You can show or hide the depth and TX frequency at the bottom left corner of the screen.

1. Open the Layers menu.
2. Select [ON] or [OFF] for [Depth Information].

8.4.4 Availability of points and event marks registration, and go to a point

For how to register points and event marks, see chapter 4.

The table below shows function availability according to latitude/longitude, heading data presence or absence. If there is no latitude/longitude data, none of the functions below are available.

Latitude/Longitude / Heading data: YES

Item	Starboard	Port
Point registration	Yes	Yes
Go to point	Yes	Yes
Event mark registration	Yes	Yes

Latitude/Longitude: YES, Heading data: NO

Item	Starboard	Port
Point registration	No	No
Go to point	No	No
Event mark registration	Yes (registered at the center)	

8.5 Cross Section Display Operations

This section covers the functions available with the cross section display. For the menu items shared with the conventional fish finder, see chapter 7. To show the [Cross Section] menu, open the Layers menu and then tap [Cross Section Settings]; or from the home screen, tap [Settings]→[Multi Beam Sonar]→[Cross Section]. The procedures in this manual, for sake of brevity, replace “open the [Cross Section] menu.”

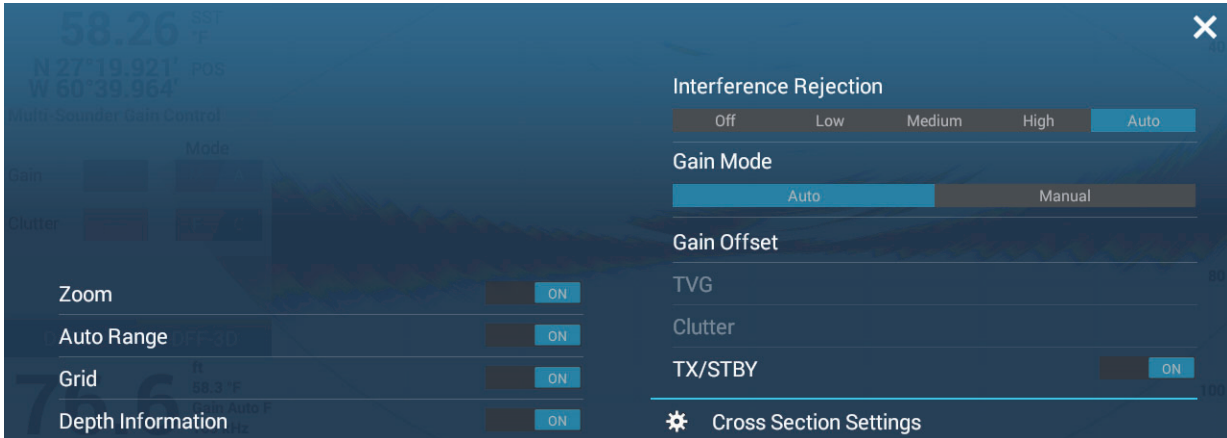

Layers menu for cross section

8.5.1 How to switch between TX and STBY

Open the Layers menu and then select [ON] for [TX/STBY] to start transmitting, [OFF] to stop transmitting. "Stand-by" appears at the center of the screen when transmission is stopped.

8.5.2 How to show or hide the grid

The grid, which is useful for measuring the distance to a target, can be shown or hidden as follows.

1. Open the Layers menu.
2. Select [ON] or [OFF] for [Grid].

8.5.3 Zoom display

The seabed echo can be zoomed.

1. Open the Layers menu.
2. Select [ON] (zoom display) or [OFF] (normal display) for [Zoom].

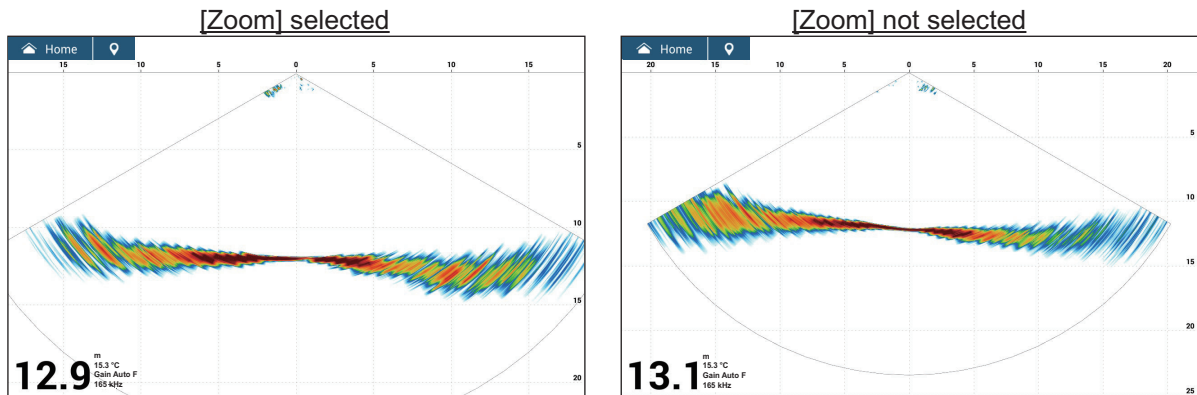

8.5.4 How to smooth echoes (distance)

If echoes are "disconnected" because of an undulating seabed, change the setting to [Low], [Medium] or [High] as necessary. Smoothing is done in the range direction to smooth the echo presentation.

1. Open the [Cross Section] menu.
2. Tap [Echo Smoothing (Distance)].
3. Select [Low], [Medium] or [High]. The default setting is [Medium]. Select [Off] to stop smoothing.
4. Tap the close button on the title bar to finish.

8.5.5 How to smooth echoes (time)

If echoes are difficult to see because they appear "speckled," use the echo smoothing feature to suppress the speckling by time.

1. Open the [Cross Section] menu.
2. Tap [Echo Smoothing (Time)].
3. Select [Low], [Medium] or [High]. The default setting is [Medium]. Select [Off] to stop smoothing.
4. Tap the close button on the title bar to finish.

8.5.6 How to apply correction to the speed of sound

Even though the sea bottom is flat, the left or right edge, up or down may be distorted. To compensate for this problem, adjust the speed of sound.

Manual correction

1. Open the [Cross Section] menu.
2. Set the correction with the software keyboard or slider bar at [Sound Speed Correction]. The setting range is -200 to 200.
3. Tap the close button on the title bar to finish.

Automatic correction

The speed of sound is automatically corrected based on the water temperature

1. Open the [Cross Section] menu.
2. Set [Temperature.Based Correction] to [ON].
3. Tap the close button on the title bar to finish.

8.5.7 How to show or hide the depth and frequency indications

You can show or hide the depth and TX frequency at the bottom left corner of the screen.

1. Open the Layers menu.
2. Select [ON] or [OFF] for [Depth Information].

8.5.8 Availability of points and event marks registration, and go to a point

For how to register points and event marks, see section 4.2.

The table below shows function availability according to latitude/longitude, heading data presence or absence. If there is no latitude/longitude data, none of the functions below are available.

Latitude/Longitude / Heading data: YES

Item	Cross section
Point registration	Yes
Go to point	No
Event mark registration	Yes

Latitude/Longitude: YES, Heading data: NO

Item	Starboard
Point registration	No
Go to point	No
Event mark registration	Yes

8.6 3D Sounder History Display Operations

This section covers the functions available with the 3D sounder history display. The 3D sounder history is able to display up to 400 past transmissions.

For the menu items shared with the conventional fish finder, see chapter 7. To show the [3D Sounder History] menu, open the Layers menu and then tap [3D Sounder Settings]; or from the home screen, tap [Settings]→[Multi Beam Sonar]→[3D Sounder History]. The procedures in this manual, for sake of brevity, replace “open the [3D Sounder History] menu.”



8.6.1 How to switch between TX and STBY

Open the Layers menu and then select [ON] for [TX/STBY] to start transmitting, [OFF] to stop transmitting. "Stand-by" appears at the center of the screen when transmission is stopped.

8.6.2 How to move, zoom in, zoom out the viewpoint position

How to move the viewpoint

The viewpoint can be moved by dragging.

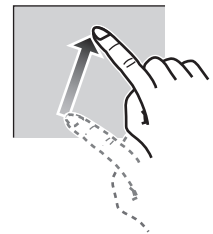

How to zoom in, zoom out

The display range can be zoomed in or out by pinching.



Zoom in



Zoom out

How to restore default view

If you get lost in viewpoint or zoom, you can restore the default view as follows.

1. Tap the 3D sounder history display to show the pop-up menu.
2. Tap [Default View].

8.6.3 How to mark school of fish

A detected school of fish can be marked with a "dot" mark for easy identification.

1. Open the Layers menu.
2. Set [Fish School] to [ON] to mark the detected school of fish with the dot mark.

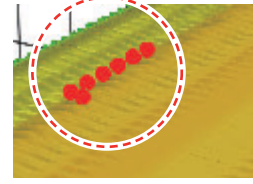

8.6.4 How to stop advancement of the display

You can stop advancement of the history display to observe the distribution of sea floor topography and school of fish.

1. Tap the 3D sounder history display to show the pop-up menu.
2. Tap [Pause] to stop the display. To restart the advancement of the history, tap [Resume] at the top right of the screen.

8.6.5 How to adjust the echo detection level

Adjust the echo detection level if schools of fish are detected unstably.

1. Open the [3D Sounder History] menu.
2. Tap [Fish Detection Level].
3. Select [Low], [Medium] or [High]. The default setting is [Medium]. If too many schools of fish are being detected, select [Low]. If too few schools are detected, select [High].
4. Tap the close button on the title bar to finish.

8.6.6 How to calibrate the seabed echo

If schools of fish or a fish reef are detected and displayed as the seabed echo, adjust the strength of the seabed echo as shown below to correctly identify the seabed echo.

1. Open the [3D Sounder History] menu.
2. Set the correction with the software keyboard or slider bar at [Seabed Echo Calibration]. The setting range is -15 to 15. A large figure helps distinguish bottom fish from the seabed echo; however, it is difficult to distinguish a fish bed. Use a small figure to distinguish a fish bed; however, it is difficult to distinguish bottom fish from the seabed echo.
3. Tap the close button on the title bar to finish.

8.6.7 How to use the bathymetry smoothing

If the bottom echo is uneven and difficult to monitor, adjust the bathymetry smoothing level to smooth the bottom echo.

1. Open the [3D Sounder History] menu.
2. Tap [Bathymetry Smoothing Level].
3. Select [Low], [Medium] or [High]. [High] provides the greatest degree of smoothing. The default setting is [Medium]. Select [Off] to stop smoothing.
4. Tap the close button on the title bar to finish.

8.6.8 How to use terrain shading

The thickness of the shading for the seabed terrain can be adjusted.

1. Open the [3D Sounder History] menu.
2. Set the thickness of the shading with the software keyboard or slider bar at [Terrain Shading]. The default setting is 50.

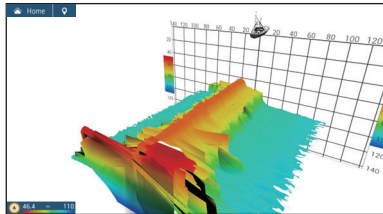

Setting: 0

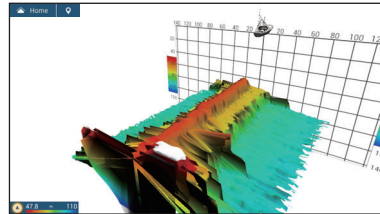

Setting: 50

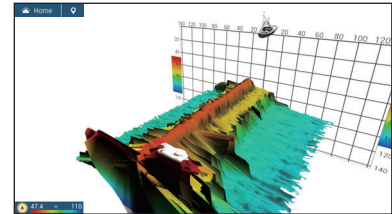

Setting: 100

3. Tap the close button on the title bar to finish.

8.6.9 How to change the picture advance speed

The picture advance setting sets how quickly vertical scan lines move across the display. When viewing a seabed with sharp rises and falls such as a reef-bed or submerged wreck, a fast advance speed helps to “smooth out” the seabed for easier viewing. On the other hand, when viewing a smooth seabed with little to no undulations, a slow advance speed helps to identify rises and falls.

Do the following to change the picture advance speed.

1. Open the Home screen, then tap [Settings]→[Multi Beam Sonar].
2. Tap [3D Sounder History].
3. Tap [Picture Advance].
4. Select an advance speed to suit your requirements.
The default speed is [1/1] (normal speed), the fastest speed is [4/1] (four times normal speed) and the slowest speed is [1/8] (eight times slower than normal speed). Select [Stop] to stop the picture advance for closer examination and screenshots/photos. The following figure shows examples of the same object at [4/1], [1/1] and [1/4] speeds.

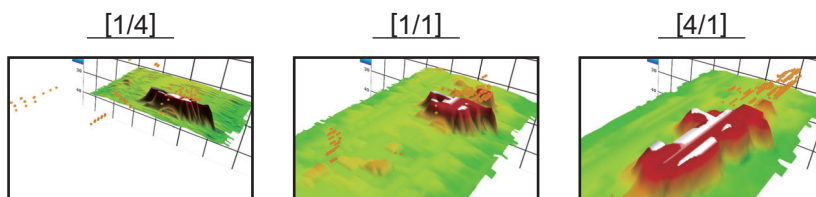

The picture advance speed can also be adjusted from the Layers menu.

8.6.10 Depth/Color Shading display

The seabed echo and schools of fish can be shown in shades of colors according to depth, to help you see the differences in depths more easily.

Color shading display

Color shading can be applied to the seabed echo or schools of fish. For the seabed display, the seabed color can be multi tone or single tone, and schools of fish can be shown in single tone or single color. For the schools of fish display, schools can be shown in multi tone or single tone and the bottom color is in single tone.

Note: Objects that are detected outside of the selected color range are shown on-screen in white color.

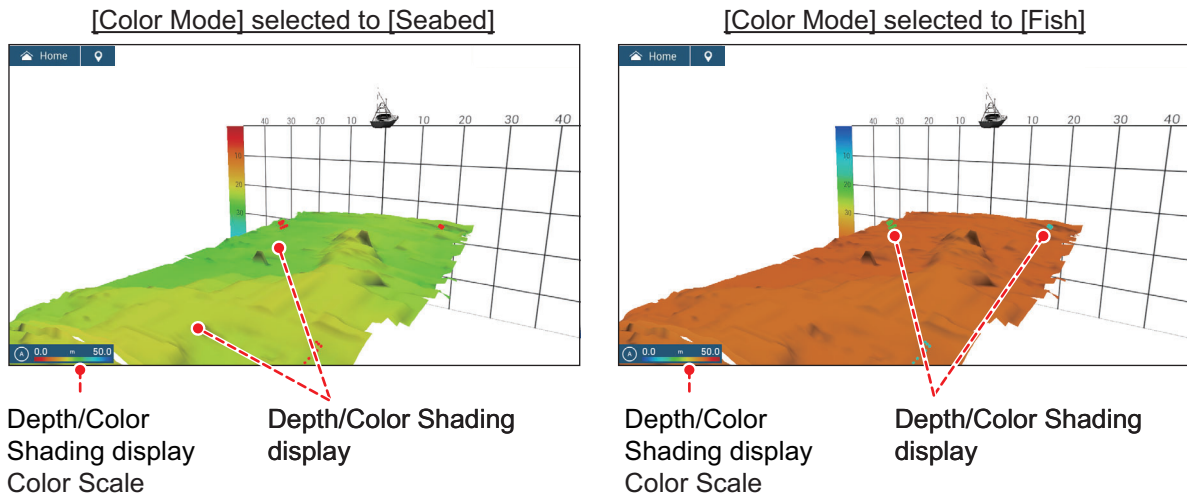

1. Open the [3D Sounder History] menu.
2. Tap [Color Mode].
3. Select [Seabed] or [Fish].

The color mode can also be selected from the Layers menu.

How to set color shading

Open the [3D Sounder History] menu and then set the following menus.

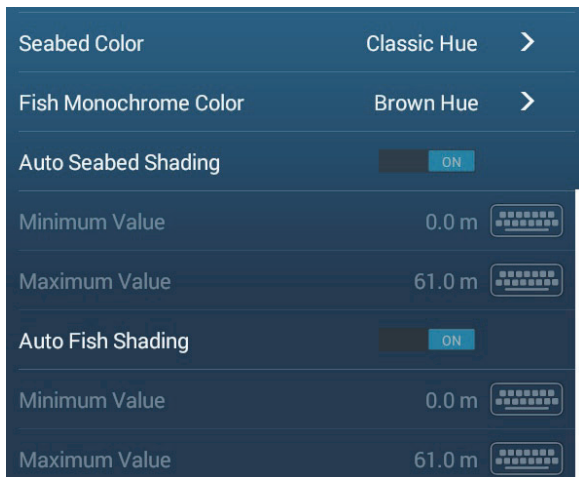

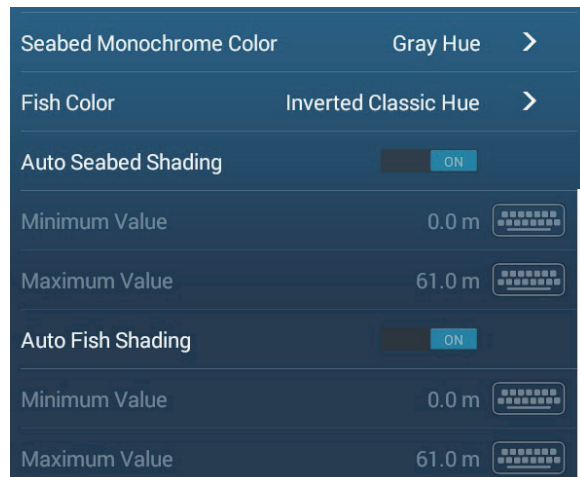

[Color Mode] selected to [Seabed]



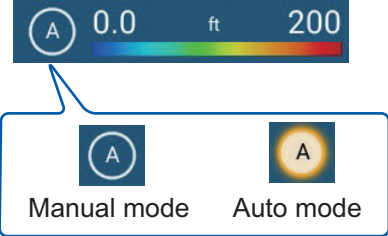

[Color Mode] selected to [Fish]

[Color Mode] selected to [Seabed]

Menu item	Description	Setting options
[Seabed Color]	For setting multi tone or single tone.	[Classic Hue], [Inverted Classic Hue], [Red Hue], [Blue Hue], [Green Hue], [Yellow Hue]
[Fish Monochrome Color]	For setting single tone or single color.	[Gray Hue], [Brown Hue], [Red], [Green], [Blue], [Cyan], [Magenta], [Black Or White], [Pink], [Light Green], [Yellow]
[Auto Seabed Shading]	<p>Use automatic or manual seabed shading.</p> <p>Tap [A] to switch between automatic and manual depth/color shading scale setting mode.</p>  <p>Note: Objects that are detected outside of the selected color range are shown on-screen in white color.</p>	[OFF] (manual), [ON] (automatic)
[Minimum Value]	<p>Use the software keyboard to set the shallowest depth to use. [Auto Seabed Shading] must be [OFF] to enter depth. Alternatively, tap the minimum value indication on the color bar scale to show the slider bar. Drag the slider bar to set. Tap [Done] to finish.</p> <p>[Minimum Value] Shallowest depth</p> 	0 to 3936 (ft)
[Maximum Value]	<p>Use the software keyboard to set the deepest depth to use. [Auto Seabed Shading] must be [OFF] to enter depth. Alternatively, tap the maximum value indication on the color bar scale to show the slider bar. Drag the slider bar to set. Tap [Done] to finish.</p> <p>[Maximum Value] Deepest depth</p> 	1 to 3937 (ft)

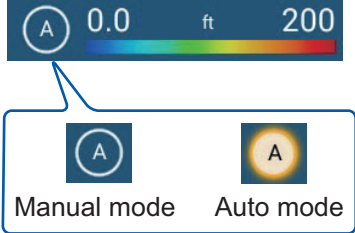
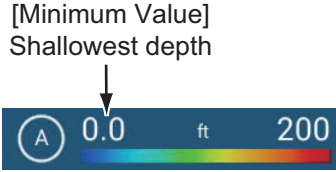
[Color Mode] selected to [Fish]

Menu item	Description	Setting options
[Seabed Monochrome Color]	For setting single tone.	[Gray Hue], [Brown Hue]
[Fish Color]	For setting multi tone or single tone.	[Classic Hue], [Inverted Classic Hue], [Red Hue], [Blue Hue], [Green Hue], [Yellow Hue]
[Auto Fish Shading]	<p>Use automatic or manual fish shading.</p> <p>Tap [A] to switch between automatic and manual depth/color shading scale setting mode.</p>  <p>Note: Objects that are detected outside of the selected color range are shown on-screen in white color.</p>	[OFF] (manual), [ON] (automatic)
[Minimum Value]	<p>Use the software keyboard to set the shallowest depth to use. [Auto Fish Shading] must be [OFF] to enter depth. Alternatively, tap the minimum value indication on the color bar scale to show the slider bar. Drag the slider bar to set. Tap [Done] to finish.</p> 	0 to 3936 (ft)
[Maximum Value]	<p>Use the software keyboard to set the deepest depth to use. [Auto Fish Shading] must be [OFF] to enter depth. Alternatively, tap the maximum value indication on the color bar scale to show the slider bar. Drag the slider bar to set. Tap [Done] to finish.</p> 	1 to 3937 (ft)

8.6.11 How to show or hide the depth and frequency indications

You can show or hide the depth and TX frequency at the bottom left corner of the screen.

1. Open the Layers menu.
2. Select [ON] or [OFF] for [Depth Information].

8.6.12 Availability of points and event marks registration, and go to a point

For how to register points and event marks, see section 4.2.

The table below shows function availability according to latitude/longitude, heading data presence or absence. If there is no latitude/longitude data, none of the functions below are available.

Latitude/Longitude / Heading data: YES

Item	Fish	Seabed	Other than Fish or Seabed
Point registration	Yes	Yes	No
Go to point	Yes	Yes	No
Event mark registration	No	No	Yes

Latitude/Longitude: YES. Heading data: NO

Item	Fish	Seabed	Other than Fish or Seabed
Point registration	No	No	No
Go to point	No	No	No
Event mark registration	No	No	Yes

8.7 PBG Recording

The PBG (Personal Bathymetric Generator) feature creates a high-definition seafloor map and displays it in different colors together with contour lines. The created data is saved to the microSD card inserted on the rear of this unit.

Note 1: Not compatible with the internal fish finder, BBDS1, DFF1, DFF1-UHD or DFF3.

Note 2: Requires position and heading data.

Note 3: PBG recordings cannot be shared among the NavNet TZtouch3 units in the network. Import or export PBG recordings as necessary. See section 9.5 for the procedures.

8.7.1 How to create PBG recordings

PBG recordings cannot be shared among the NavNet TZtouch3 units in the network. Import or export PBG recordings as necessary. See section 9.5.

Open the Slide-out menu on the chart plotter display, then tap [PBG Recording] to start recording the seafloor. The icon turns yellow. A blue line indicating the recording range appears behind the own ship icon, and a seafloor topographic map is drawn. The width of the line is short in shallow waters and long in deep waters.

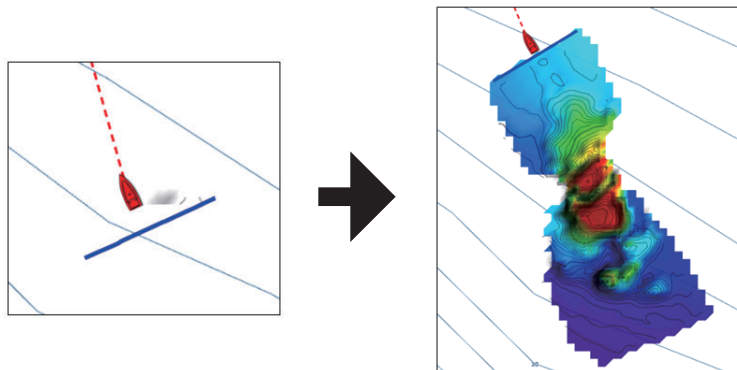

To stop the recording, open the Slide-out menu, then tap [PBG Recording]. The icon turns white.

8.7.2 How to set the speed filter

You can stop recording when the speed exceeds the set speed. Stopping recording while cruising at high speed prevents the size of the map data from increasing.

1. Home screen→[Settings]→[Chart Plotter].
2. Set [Speed Filter] to [ON].
3. Tap [Maximum Value] to show the software keyboard.
4. Enter the speed (setting range: 3.0 to 30 kn) at which to stop recording, then tap [✓].
5. Tap the close button on the title bar to finish and close the menu.

8.7.3 How to display, arrange a PBG recording

Show the chart plotter display, then open the Layers menu. Set [Depth Shading] to [DFF-3D]. [Depth Shading] is automatically selected to [DFF-3D] whenever PBG recording is started.

Option	Description
[OFF]	Turn off [Depth Shading], PBG recording.
[3D Chart]	[Depth Shading] using chart data.
[HR 3D Chart]	No use.
[DFF-3D]	[Depth Shading] using PBG recording.

Depth shading colors

Six depth shading colors are available. For details, see section 3.2.1.

Depth contours

In the default setting, depth contours are automatically overlaid on a PBG recording when the recording is displayed. To hide the contours, open the Layers menu, then turn [Depth Contours] on or off as required.

To show the contour lines in monochrome color, see "How to set color shading" on page 8-16.

PBG terrain shading

You can apply shading the PBG terrain to emphasize the terrain.

1. Home screen→[Settings]→[Chart Plotter].
2. At [PBG Terrain], select the degree of terrain shading, among [Light], [Medium] and [Strong]. For no shading, select [Off].
3. Tap the close button on the title bar to finish and close the menu.

8.7.4 How to delete PBG recordings

A PBG recording cannot be deleted while recording.

How to delete a part of a PBG recording

1. On the chart plotter display, tap anywhere on the PBG recording to show the pop-up menu.
2. Tap [Delete PBG Area]. An icon appears where you tapped the screen.



3. Drag the icon to the start point of the area to delete.

Range	11.70 NM
Bearing	178.1 ° R
New Point	
Goto	
Fish-It	
New Route	
New Boundary >	
Tide	
Chart Info	
Delete PBG Area	

8. MULTI BEAM SONAR DFF-3D

4. Tap the screen several times to set the area. In the example figure below, the area inside the square will be deleted.

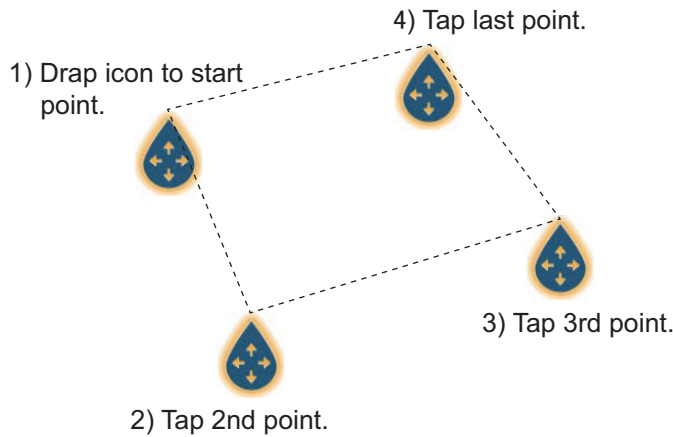

5. Tap [Delete] at the tap right corner.
A message indicates the PBG recording is being deleted.

How to delete all PBG recordings

Delete the "PBG" folder from the microSD card.

8.7.5 How to apply correction to the speed of sound

The speed of sound through water may increase or decrease depending on the water temperature and salinity. The DFF-3D transmits multiple beams at various angles to generate echoes in a 120° range to the left and right, but when the speed of sound changes, the transmission angle shifts outward or inward from the original angle. The DFF-3D is designed to automatically correct this deviation, but if the speed of sound changes beyond the correction range, the center of the seabed will rise or fall. In such cases, correct the speed of sound manually, referring to section 8.5.6.

When the beam is shifted outward

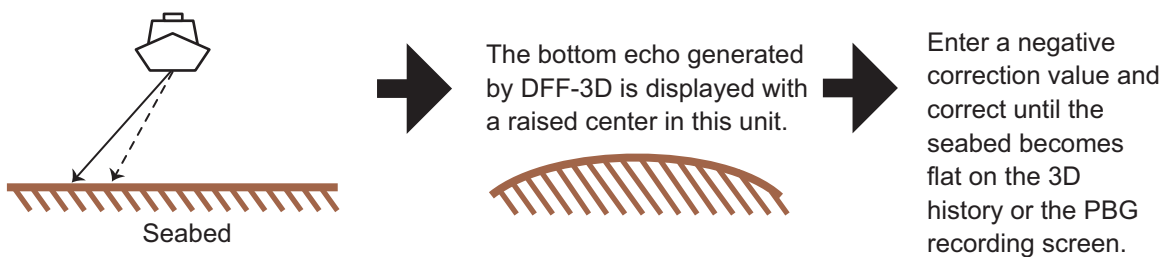

When the beam is shifted inward

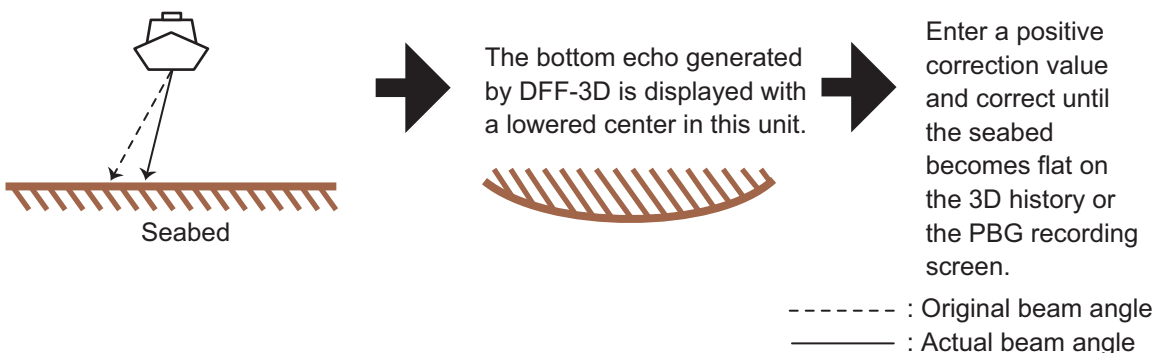

9. FILE OPERATIONS

Points, routes, boundaries, tracks, photos, catch logs, PBG recordings, and setting data (backup, import) can be imported and exported using the USB port. Additionally, with a My Time Zero™* account, you can save settings data to the My Time Zero™* data service cloud. The card slot at the back of the MFD holds microSD cards, and is exclusively for use with chart cards (data cannot not written to or read from a micro SD card).

The table below outlines the media that can be used with your unit.

Action	MicroSD Card		USB flash memory
	SD Card Unit (SDU-001, option)	SD card converter adapter	
Export data	Yes	Yes	Yes
Import data	Yes	Yes	Yes

Note: For care and handling of microSD cards see section 1.11.

Handling USB flash memory

- Format the USB flash memory or microSD card to file system FAT32. The capacity of the media should be 32GB or less.
- Do not use a secure USB flash memory.
- Turn off the power before inserting or removing the media connected to the USB port, to prevent corruption of data.

9.1 File Format

You can select the file format to use to export data.

1. Open the Home screen, then tap [Settings]→[Files].



2. Tap [Export File Format].

9. FILE OPERATIONS

3. Tap desired file format, among [TZD], [CSV], [GPX].
[TZX]: For NavNet TZtouch3
[TZD]: For NavNet TZtouch2
[CSV]^{*1}: For NavNet3D
[GPX]^{*2}: For use with PC plotter

^{*1}: The CSV format has the following capacity restrictions:

- Points: Max. 2,000
- Routes: Max. 200 (100 points/route)
- Track: Max. 10,000

^{*2}: When exporting data in GPX format, it is recommended to make a note of the data contained in the file. GPX files names do not indicate their contents.

4. Tap the close button on the title bar to finish.

9.2 How to Export User Objects

This unit holds a maximum of 30,000 points, 200 routes, 100 polygon areas, (boundaries), 100 circles (boundaries), 1,000 screenshots, and 1,000 catches. When the capacity for routes/points is full, new data cannot be stored. If you need to save the above-mentioned items permanently, save them to a media, following the procedure below.

1. Put a formatted media in the USB port.
2. Open the Home screen, then tap [Settings]→[Files]→[Export User Objects].
3. A confirmation message asks you if you are sure to proceed.
4. Tap [OK]. The message "EXPORT SUCCEEDED" appears if the exporting was successful.
5. Tap [OK] to erase the message.
6. Tap the close button on the title bar to finish.

9.3 How to Import User Objects

You can import points, routes and boundary lines to the internal memory of this unit, using a SD card, microSD card or USB flash memory.

1. Put the appropriate formatted media in the USB port.
2. Open the Home screen, then tap →[Files]→[Import User Objects]. A list of files stored on the inserted media appears.

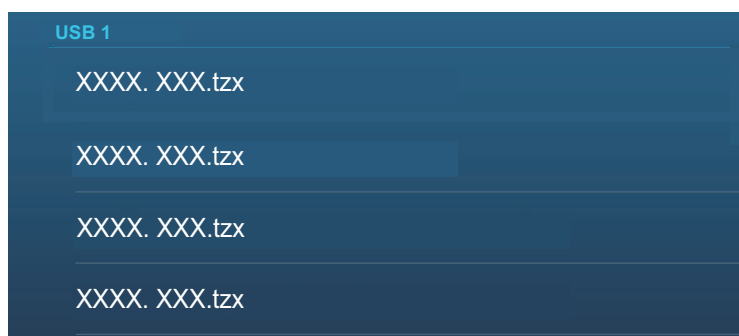

3. Tap the file(s) to import. You are asked if you are sure to import selected items.
4. Tap [OK]. The message "IMPORT SUCCEEDED" appears if the importing was successful.
5. Tap the [OK] to erase the message.
6. Tap the close button on the title bar to finish.

9.4 How to Export, Import Tracks

How to export tracks

This unit saves up to 30,000 points of track data. You can export all tracks to a media as follows.

1. Put the appropriate media in the USB port.
2. Open the Home screen, then tap [Settings]→[Files]→[Export Tracks]. A list of files stored on the SD card or USB flash memory appears.
3. Tap the destination for the track. You are asked if you are sure to proceed.
4. Tap [OK]. The message "EXPORT SUCCEEDED" appears if the exporting was successful.
5. Tap [OK] to erase the message.
6. Tap the close button on the title bar to finish.

How to import tracks

You can import the tracks stored on a media to the internal memory of this unit.

Note: Imported track is transferred to each NavNet TZtouch3 unit. Track cannot be shared among units in the network.

1. Put the appropriate formatted media in the USB port.
2. From the Home screen, tap [Settings]→[Files]→[Import Tracks]. A list of tracks stored in the media appears.

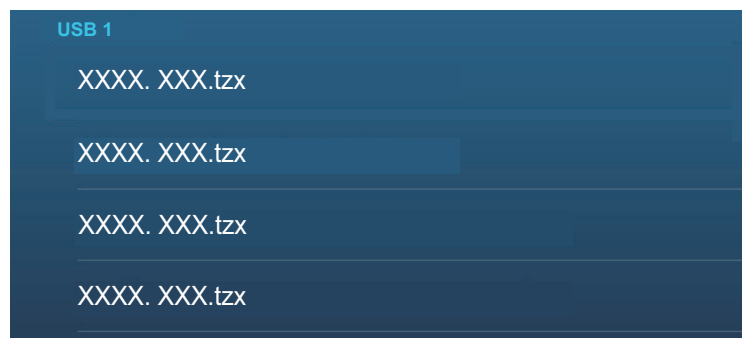

3. Tap the tracks file to import. You are asked if you are sure to import tracks.
4. Tap [OK]. The message "IMPORT SUCCEEDED" appears if the exporting was successful.
5. Tap [OK] to erase the message.
6. Tap the close button on the title bar to finish.

9.5 How to Export, Import PBG Recordings

How to export PBG recordings

You can export PBG recordings to a media as follows.

1. Put the appropriate formatted media in the USB port.
2. Open the Home screen, then tap [Settings]→[Files]→[Export PBG].
3. Tap the destination for the PBG recording. You are asked if you are sure to proceed.
4. Tap [OK]. The message "EXPORT SUCCEEDED" appears if the exporting was successful.
5. Tap [OK] to erase the message.
6. Tap the close button on the title bar to finish.

Note: A PBG recording cannot be displayed on a NavNet TZ touch3 simply by inserting a media into the unit. Do "How to import PBG recordings" to display a PBG recording.

How to import PBG recordings

You can import the PBG recordings stored on a media, to the internal memory of this unit.

Note: Imported PBG recordings cannot be shared among NavNet TZtouch3 units within the network. You must import a recording to each unit in the network.

1. Put the appropriate media in the USB port.
2. From the Home screen, tap [Settings]→[Files]→[Import PBG]. A list of PBG recordings stored in the media appears.
3. Tap the PBG recording file(s) to import. You are asked if you are sure to import the selected PBG recordings.
4. Tap [OK]. The message "IMPORT SUCCEEDED" appears if the exporting was successful.
5. Tap [OK] to erase the message.
6. Tap the close button on the title bar to finish.

9.6 How to Export (Backup) the Equipment Settings

You can export the settings data to the SD card inserted in SD card unit or the media inserted in the USB port to use the settings on other NavNet TZtouch3 units.

1. Put the appropriate formatted media in the USB port.
2. Open the Home screen, then tap [Settings]→[Files]→[Backup Settings]. A list of files stored on the SD card or USB flash memory appears.
3. Tap the destination for the equipment settings. You are asked if you are sure to proceed. The message "EXPORT SUCCEEDED" appears if the exporting was successful.
4. Tap [OK] to erase the message.
5. Tap the close button on the title bar to finish.

9.7 How to Import the Equipment Settings

You can import saved settings data from an appropriate media to this unit, and share them with the NavNet TZtouch3 units in the NavNet network.

1. Put the appropriate media in the USB port
2. Open the Home screen, then tap [Settings]→[Files]→[Restore Settings]. A list of user settings stored on the card in the media appears.

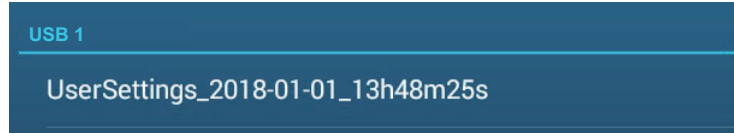

3. Tap the file to import. A confirmation message appears.
4. Tap [OK]. The message "IMPORT SUCCEEDED" appears if the importing was successful.
5. Tap [OK] to erase the message.
6. Tap the close button on the title bar to finish.

9.8 My TimeZero Cloud Data Service

With the TimeZero™ cloud data service, you can share data (settings, points, routes and tracks) stored in your TimeZero™ cloud account with another NavNet TZtouch3. To use the TimeZero™ cloud data service, connect to the internet and create a TimeZero™ account.

9.8.1 How to save settings/data to the cloud

Do as follows to save settings data to the cloud.

1. Open the Home screen, then tap [Settings]→[General].
2. Tap [Login] at the [SOCIAL NETWORK] section and login to your TimeZero™ account.
3. Tap "<" on the title bar to return to the [Settings] menu.
4. Tap [Files]→[Backup Settings in the Cloud]. If the file already exists in the cloud, you are informed that the file exists and are you sure to proceed. Tap [OK] to write over the existing file.

9.8.2 How to retrieve settings/data from the cloud

Do as follows to retrieve settings data from the cloud.

1. Open the Home screen, then tap [Settings]→[General].
2. Tap [Login] at the SOCIAL NETWORK section and login to your TimeZero™ account.
3. Tap "<" on the title bar to return to the [Settings] menu.
4. Tap [Files]→[Restore Settings From the Cloud]. You are asked if you are sure to retrieve settings. Tap [OK] to erase the message.
5. Tap [OK] to write over settings data stored in the MFD. If there is no settings data in the cloud, a message informs you of no data. Tap [OK] to erase the message.

10. CAMERA/VIDEO/EXTERNAL EQUIPMENT

The camera/video function allows you to use your unit to play back images from a video player, on-board camera, network camera, DVD player and other compatible devices. The image from a network camera can be seen by all NavNet TZtouch3 MFD units in the NavNet network, however it cannot be seen on the NavNet series MFD. Image size, brightness, contrast and the color of images can be adjusted.

Note: The TZT9F does not support Analog IN or HDMI IN.

10.1 How to Display a Video Image

To show the camera display, go to the Home screen, then tap [Settings]→[Camera]. Turn on the [Connected] flipswitch at [ANALOG CAMERA 1] (or 2)*, or connect a network camera. Return to the Home screen, then tap the camera display icon to activate the camera display.

* Analog camera not supported by TZT9F.



Note: The Home icon does not appear when the camera display is active. To show the Home icon, tap the camera display.

10.2 Video Signal Types

There are five types of video signals which can be connected to this equipment.

- **Digital signal (HDMI)*:** Images from surveillance cameras, on-board cameras and video playback.
Note: This feature is available with TZT16F/19F.
 - **Analog signal*:** Images from surveillance cameras, on-board cameras and video playback.
Note: This feature is available with TZT12F/16F/19F.
 - **Digital signal (IP)*:** Images from a network camera.
Note: Turn on the network camera first, then turn on the MFD.
 - **Digital signal (sonar):** Video output signal from the sonar CSH-8L.
Note: Requires HDMI converter cable and converter.
 - **Axis Quad Server:** The image from an Axis Quad Server, which can feed up to four lines of video signals simultaneously.
 - **FLIR:** Images from a FLIR brand infrared camera
- * These signals can be output and shared with all NavNet TZtouch3 units connected in the network, by connecting a video encoder.

Compatible FLIR cameras

The following FLIR cameras are compatible with this equipment, as of 12/2020. M132, M232, M300C, M332, M364, M364C, M364CLR, M400, M400XR, M500

Note: The ClearCruise™ function of FLIR cameras is inoperative with the NavNet TZtouch3.

Camera display combinations

The images from a maximum of two cameras can be displayed simultaneously.

Note: The images from two analog cameras cannot be displayed simultaneously.

See the table below for the combination of cameras that can show their images simultaneously.

	Analog 1	Analog 2	IP Cam. 1	IP Cam. 2	IP Cam. 3	IP Cam. 4	Axis Quad Serv.	2nd Axis Quad Serv.	HDMI Input
Analog 1	No	No	Yes	Yes	Yes	Yes	Yes	Yes	Yes
Analog 2	No	No	Yes	Yes	Yes	Yes	Yes	Yes	Yes
IP Cam. 1	Yes	Yes	Yes	Yes	Yes	Yes	Yes	Yes	Yes
IP Cam. 2	Yes	Yes	Yes	Yes	Yes	Yes	Yes	Yes	Yes
IP Cam. 3	Yes	Yes	Yes	Yes	Yes	Yes	Yes	Yes	Yes
IP Cam. 4	Yes	Yes	Yes	Yes	Yes	Yes	Yes	Yes	Yes
Axis Quad Serv.	Yes	Yes	Yes	Yes	Yes	Yes	Yes	Yes	Yes
2nd Axis Quad Serv.	Yes	Yes	Yes	Yes	Yes	Yes	Yes	Yes	Yes
HDMI Input	Yes	Yes	Yes	Yes	Yes	Yes	Yes	Yes	No

10.3 How to Set the Camera Display

This section shows you how to set up the camera display, on the [Camera] menu. The Camera menu can be accessed two ways:

- **From the Home screen:** Tap [Settings]→[General]→[Camera].
- **From the Layers menu:** Open the Layers menu to show camera settings.

In this manual, this operation is referred to as “Open the [Camera] menu.”

10.3.1 How to set the video signal

HDMI Input

Note: This feature is available with TZT16F/19F.

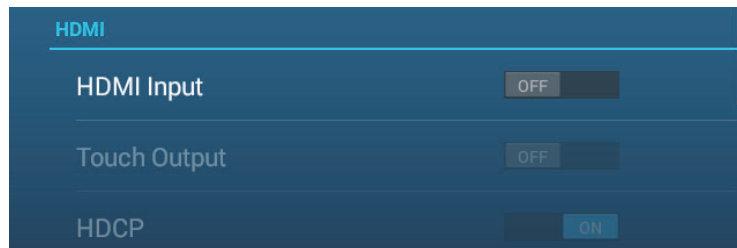

[HDMI Input]: Select [ON] when video equipment is connected to the HDMI IN ports.

[Touch Output]: See section 10.5.

[HDCP]: Select [ON] when connecting HDCP playback devices such as DVD and Blu-ray players.

Video Input 1/Video Input 2 (analog, FLIR)

Note: This feature is available with TZT12F/16F/19F.

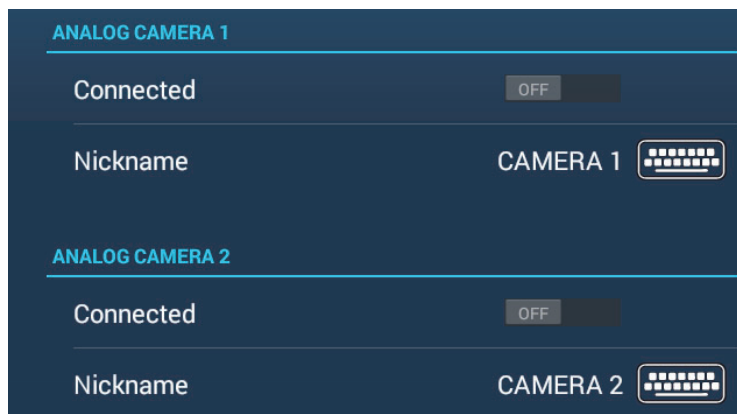

[Connected]: Turn on to use the device (video equipment, FLIR camera) connected to the VIDEO-IN1, VIDEO-IN2 port.

[Nickname]: If desired, you change the name of the analog camera(s). The default names are [CAMERA1], [CAMERA 2]. You can use a maximum of 20 characters. To change a name, tap [Nickname] to show the software keyboard. Change the name, then tap [✓] to finish. The name is reflected to the following locations.

- The name that appears at the bottom right corner of the camera display.
- Home screen→[Settings]→[Camera]→[FLIR Installation]→[Video Source]

IP camera

The IP address and the signal name for the IP camera signal can be changed as shown below. Additionally PTZ control can be turned on or off.

The screenshot displays a configuration screen for IP cameras, organized into four sections: IP CAMERA 1, IP CAMERA 2, IP CAMERA 3, and IP CAMERA 4. Each section contains three rows of settings:

- Nickname:** The default name for each camera (e.g., IP CAMERA 1).
- IP Camera:** The IP address assigned to each camera (e.g., 172.31.200.3).
- PTZ Control:** A toggle switch set to OFF.

Each text field has a keyboard icon to its right, and the PTZ Control toggle is a dark grey button with the word 'OFF' in white.

[Nickname]: If desired you can change the name of the IP camera(s). The default names are [IP CAMERA 1], [IP CAMERA 2], [IP CAMERA 3], [IP CAMERA 4]. You can use a maximum of 20 characters. To change a name, tap [Nickname] to show the software keyboard. Change the name, then tap [✓] to finish. The name is reflected to the following locations.

- The name that appears at the bottom right corner of the camera display.
- Home screen → [Settings] → [Camera] → [FLIR Installation] → [Video Source]

[IP Camera]: Enter the IP address of the IP camera, using the software keyboard. Tap [✓] to finish.

[PTZ Control]: Turn this item on to enable PTZ (Pan, Tilt, Zoom) control of the camera.

Note: [PTZ Control] should only be used when the connected camera is compatible with the PTZ function. Activating the [PTZ Control] function when the camera is not compatible may cause problems with this equipment's regular functions.

Video streaming signal

Axis Quad Server digital signal

A maximum of two Axis Quad Servers can be connected. Each server can be set individually with the menus [AXIS QUAD SERVER] and [SECOND AXIS QUAD SERVER], respectively.

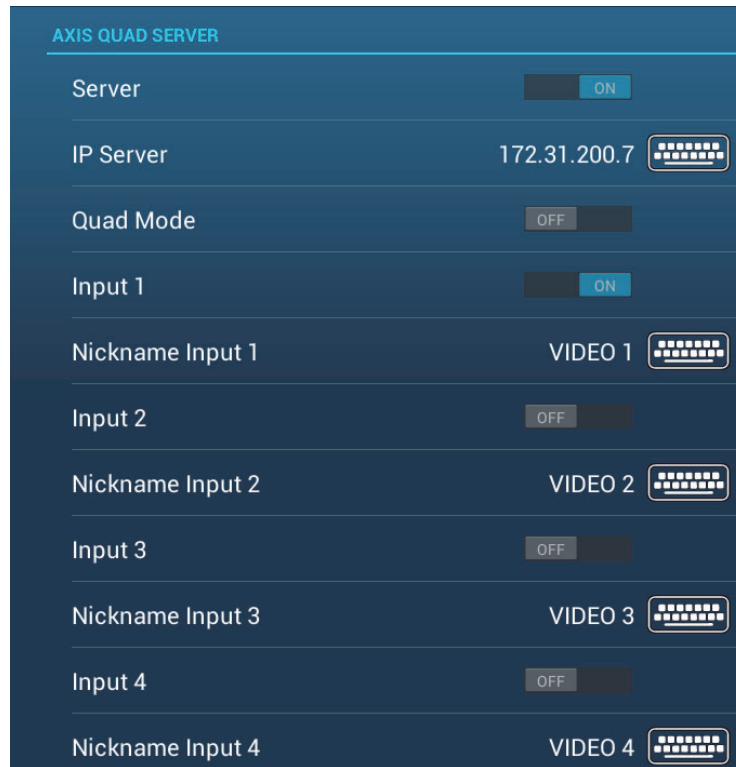

[Server]: Turn this item on to receive the signal from the Axis Quad Server.

[IP Server]: Enter the IP address of the server, using the software keyboard. Tap [✓] to finish.

[Quad Mode]: Turn this item on to feed four channels simultaneously to one display.

[Input 1] (2, 3, 4): Turn this item on to feed each of the four channels of the server individually.

[Nickname]: If desired you can change the name of the Axis Quad Server(s). The default names are [VIDEO 1], [VIDEO 2], [VIDEO 3], [VIDEO 4]. You can use a maximum of 20 characters. To change a name, tap [Nickname Input 1] (2, 3, 4) to show the software keyboard. Change the name, then tap [✓] to finish. The name is reflected to the following locations.

- The name that appears at the bottom right corner of the camera display.
- Home screen → [Settings] → [Camera] → [FLIR Installation] → [Video Source]

FLIR camera

Images from an infrared camera allow you to navigate easily at night or in bad weather. Open the Home screen, then tap [Settings]→[Camera]→[FLIR Installation] (in [CONTROLLABLE CAMERA] section).



Note: To use the PTZ function of the FLIR camera with the NavNet TZtouch3, a setting (Nexus CGI Interface, port: 8090) is required at the FLIR camera. See the operator's manual of the FLIR camera for details.

[Scan IP]: Tap [Scan IP] to scan the IP address automatically when connecting an FLIR camera.

- FLIR M-Series: M324CS, M324S
- FLIR M200: M132, M232
- FLIR M300: M300C, M364C, M364C LR
- FLIR M400: M400

[Video Source]: Select the port where your FLIR camera is connected. (Not shown with the FLIR M300.)

[Camera Model]: Select the FLIR camera model connected to your MFD.

[Camera Offset (Right-left)]: Adjust the side position of the FLIR camera.

[Camera Offset (Up-down)]: Adjust the up-and down position of the FLIR camera.

[Automatic Zoom]: Turn on to turn on the automatic zoom.

[Zoom Distance]: Set the distance to zoom automatically.

[Camera Altitude]: Set the altitude for the FLIR camera.

10.3.2 How to switch your video inputs

If you have more than one camera installed, you can switch your video inputs from the camera screen.

1. Open the Layers menu.

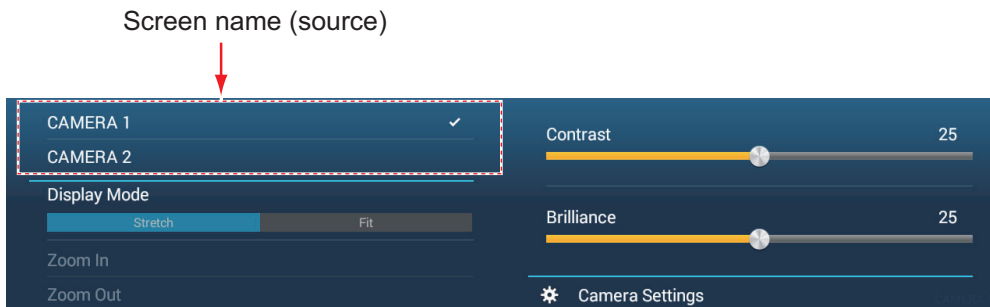

Example: Two cameras connected

The display contents depends on the cameras connected.

2. Tap the screen name of the camera you want to display.

10.3.3 How to adjust the image size

You can adjust the image size from the Layers menu.

1. Open the Layers menu.
2. For multiple camera installation, see section 10.3.2 for how to select video input source.
3. At [Display Mode], tap [Stretch] or [Fit].

[Stretch]: Shrink or enlarge the image to fit the monitor's width.

[Fit]: Shrink or enlarge the image to fit the monitor's height. The aspect ratio is kept, so a black bar appears on the right and left sides of the picture. This is normal; it is not a sign of malfunction.

10.3.4 How to adjust the video image

Open the Layers menu, that adjust the slider bar for [Contrast] or [Brilliance].

10.4 Control of FLIR Camera

[Camera FoV] menu

You can display the field of view captured by the FLIR camera on the chart plotter display.

1. Tap the own ship icon to display the pop-up menu.
2. Turn on [Cone]. The own ship icon is put inside a red translucent circle.

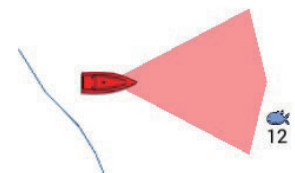

[Move Camera] and [Lock Camera] menus



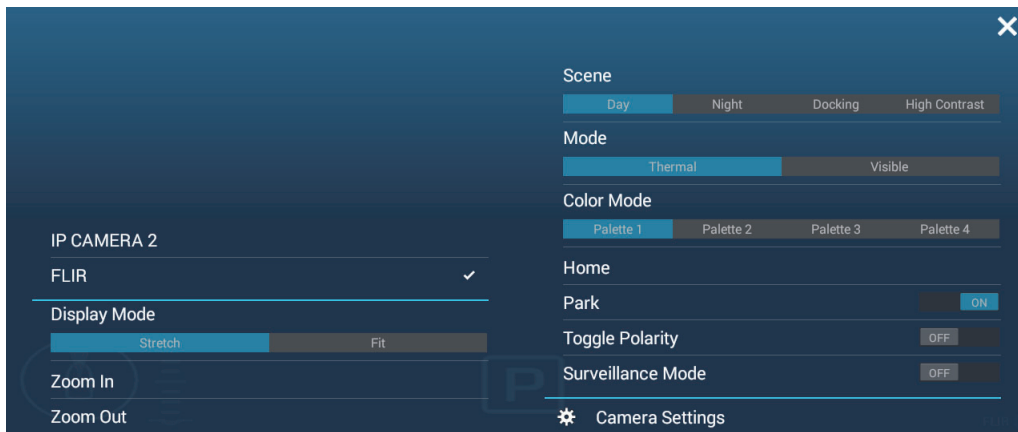

You can rotate the FLIR camera about the position you select (touch) on the plotter or radar display. Open the pop-up menu then tap [Lock Camera]. To track the position, tap [Move Camera] on the pop-up menu. To disable the camera tracking, tap [Unlock Camera] on the pop-up menu.

Operations from the Layers menu

[Zoom In] and [Zoom Out] adjust the image size (see section 10.3.2). [Home] restores camera reference position. [Park] stops the video output when the camera lens is facing downward, thereby reducing power consumption. For all other menu items, see the FLIR Operator’s Manual.

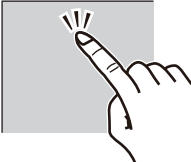

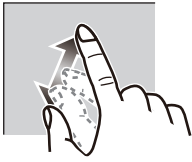
Touchpanel operations with a FLIR Camera

	Operation	Function
Tap		Points camera to direction tapped.
Drag		Rotates camera while dragging.
Pinch	  <p style="text-align: center;">Zoom in Zoom out</p>	Zoom in/zoom out the camera image (infrared only).

10.5 Operating External Equipment

You can control external equipment (such as on-board monitoring and digital switching) by connecting the external equipment via the HDMI Input ports, and the touch monitors via the USB ports on the TZT16F/19F.

Note: This feature is not available with the TZT9F/12F.

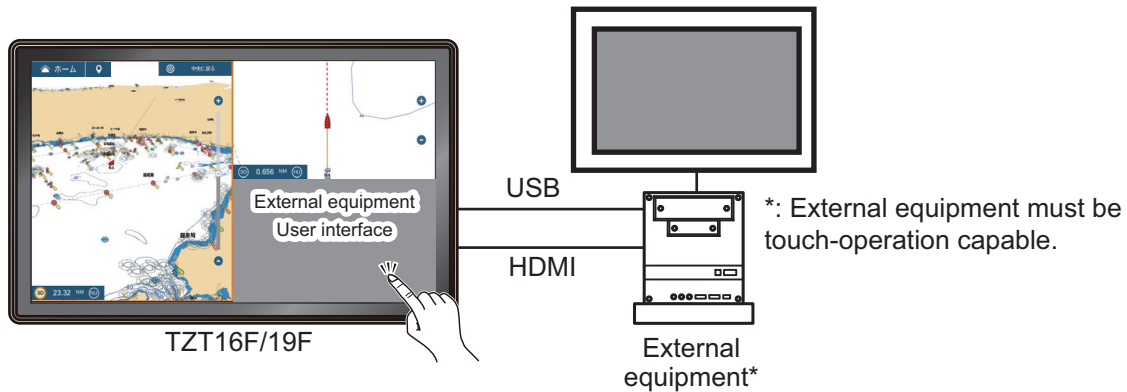

Configuration example

How to set up operation of external equipment

1. Open the [Camera] menu.
2. Set both [HDMI Input] and [Touch Output] to [ON].

How to show the external equipment's display

From the Home screen, tap the Camera icon to show the external equipment's display appears.

Layers menu

With the external equipment display shown, tap the menu icon (☰) at the top-right of the screen to show the Layers menu.

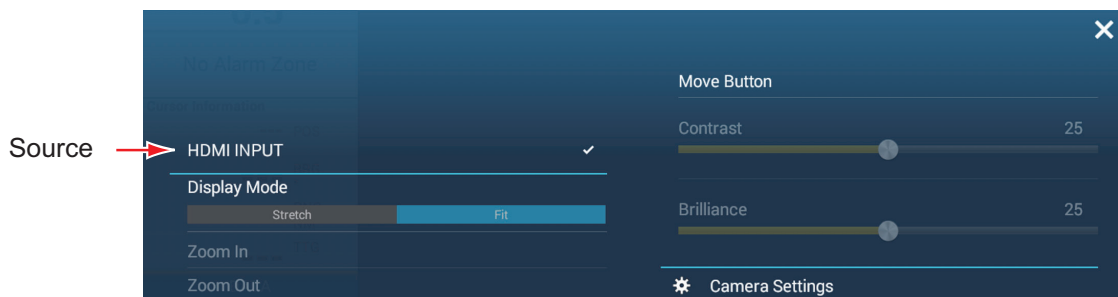

[Source]: See section 10.3.2.

[Display Mode]: Adjust the image size with [Stretch], [Fit]. See section 10.3.3.

[Zoom In]: No use.

[Zoom Out]: No use.

10. CAMERA/VIDEO/EXTERNAL EQUIPMENT

[Move Button]: Moves the menu icon. You can also long tap the menu icon to move the icon. The icon changes to show flashing arrows () indicating that the icon can now be moved. Drag the icon to the desired location, then tap the icon. The flashing arrows disappear and the icon is anchored to the location.

[Contrast]: No use.

[Brilliance]: No use.

[Camera Settings]: Opens the [Camera] menu.

10.6 Sonar Video

With connection of the FURUNO Scanning Sonar CSH-8L MARK-2, sonar images can be displayed on this unit and shared with all the NavNet TZ touch3 units in the same network.

Note: Connect the video encoder and this unit via LAN. For the settings of the video encoder, refer to its instruction manual.

How to show the sonar video display

To show the sonar video display, go to the Home screen, tap [Settings]→[Camera], then turn on [Use as Sonar Video Input] to activate the sonar video display. Tap the sonar video icon to show the sonar video display.



Sonar video settings

Sonar video settings are available in the [VIDEO STREAMING] section in the [Camera] menu.

[Nickname]: The default nickname is [SONAR], however you can change the name to something that is more appropriate for you. The nickname can be a maximum of 20 characters. To change the nickname, tap [Nickname] to show the software keyboard. Change the name, then tap [✓]. The name appears at the bottom right corner of the sonar video display.

[URL]: Enter the RTSP URL address (numerics*) that appears on the video encoder status screen.

* Example: If the RTSP URL is `rtsp://172.31.200.14/0`, enter "172.31.200.14/0" (without the quotation marks).

[Use as Sonar Video Input]: Turn on to input the sonar video.

10. CAMERA/VIDEO/EXTERNAL EQUIPMENT

This page is intentionally left blank.

11. FUSION-Link

The FUSION-Link™ product from FUSION Entertainment allows compatible NavNet TZtouch3 displays to interface and control specialized FUSION marine entertainment equipment. The following FUSION-Link™ products are compatible with the multi function display, as of 1/2019.

Series name	Model
750 series	MS-AV750, MS-UD750
755 series	MS-AV755, MS-UD755
Apollo series	MS-RA770, MS-SRX400

Note 1: The Apollo series units have a built-in WiFi, however connect the unit to the LAN of NavNet TZtouch3. The PartyBus™ feature of the Apollo is inoperative with the multi function display.

Note 2: For audio output, a speaker (locally arranged) must be connected to a FUSION-Link compatible device.

11.1 FUSION Display

The FUSION display can be accessed two ways.

- **From the Home screen**



Fusion display

- **Two finger tap (long) on screen**
Set [Two Finger Log Tap Function] to [Fusion], on the [General] menu, to use this feature. See section 1.16 for the procedure.

11. FUSION-Link

 Zones 1 and 2 volumes synched.

 Zones 1 and 2 volumes independent.

 : Select tracks or albums.

 : Repeat one or all.





Annotations for the screenshot:

- Close button:** A red circle around the 'X' icon in the top right corner.
- Drag slider to adjust volume. Globally adjust volume.:** A red arrow pointing to the 'Global' volume slider on the left.
- Show or hide [ZONES] panel.:** A red arrow pointing to the 'ZONES' panel header on the left.
- Show or hide [TONES] panel (tone controls).:** A red arrow pointing to the 'TONES' panel header on the right.
- Swipe to change source.:** A red arrow pointing to the source selection area (USB, iPod, MTP) at the bottom.
- Show or hide [MENU] panel.:** A red arrow pointing to the menu icon (three horizontal lines) at the bottom right.

 Tap: Goto previous title.
Hold down: Go back.

 Playback

 Tap: Goto next number.
Hold down: Fast forward.

 Lower volume.

 Mute/unmute.

 Raise volume.

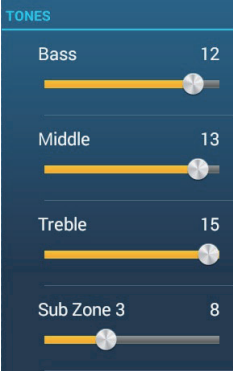

TONES

- Bass: 12
- Middle: 13
- Treble: 15
- Sub Zone 3: 8

Example1: iPod, full screen

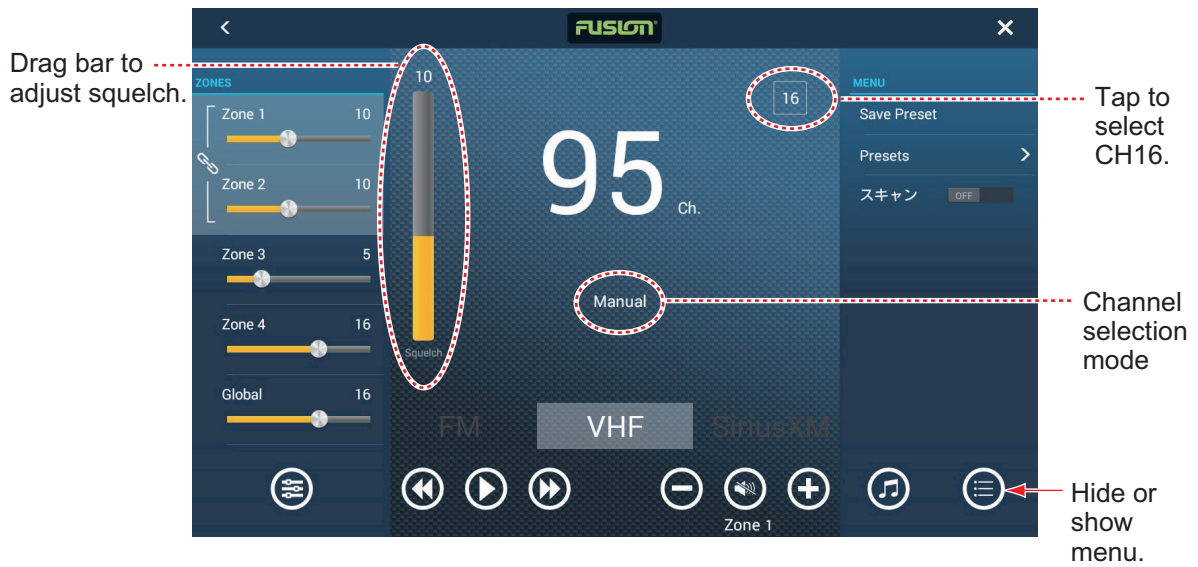

Select channel.



Lower volume.



Tap: Switch channel selection mode between preset and manual.
Long tap: After selecting channel in manual mode, long tap to register the channel as preset channel.



Mute/unmute.



Raise volume.

Example2: VHF, full screen

11.2 FUSION Operation Bar

The FUSION controls can be accessed two ways:

- Tap Fusion on the Slide-out menu.

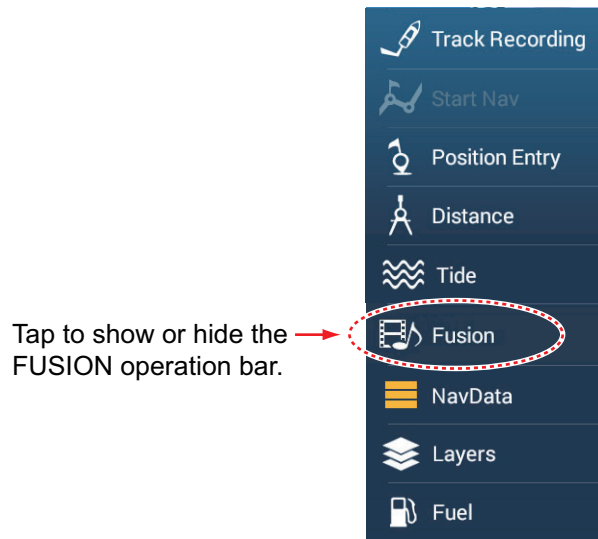

- Tap (long tap) the screen with two fingers.

Note: [Two Finger Long Tap Function] ([General] menu) must be set to [Fusion Bar] to use this method.

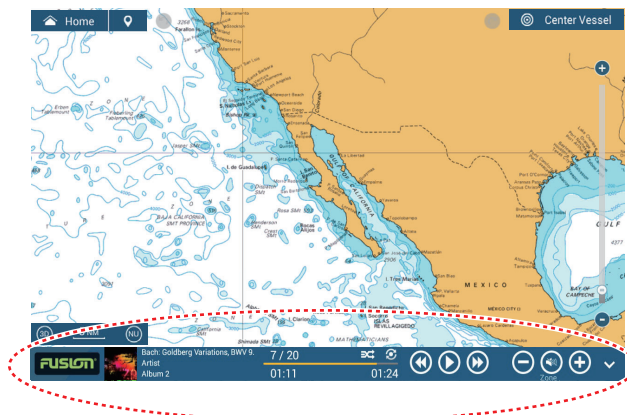

Tap to go to full screen FUSION display.

Tap to hide bar.



For iPod



For VHF

11.3 FUSION Settings

Open the Home screen, tap [Initial Setup], then scroll down to find the [FUSION] section. Set the [FUSION] items referring to the descriptions shown below.

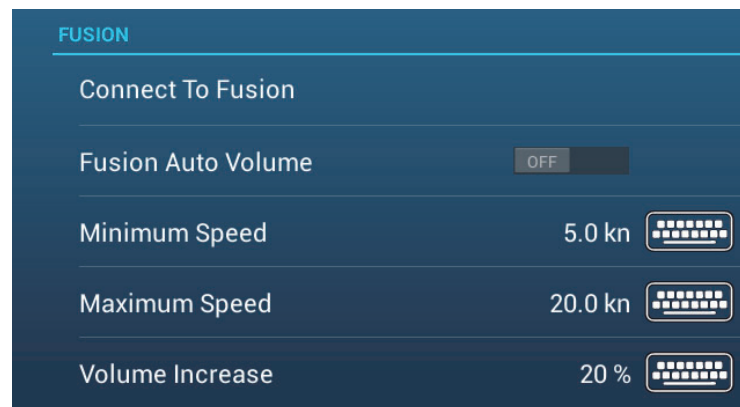

[Connect to Fusion]: Connects to your FUSION equipment.

[Fusion Auto Volume]: Set to [ON] to allow the NavNet TZtouch3 unit to control the FUSION volume.

[Minimum Speed]: Set the minimum speed that triggers the volume auto control.

[Maximum Speed]: Set the maximum speed that triggers the volume auto control.

[Volume Increase]: Set the amount of extra volume to output when the speed is that set at [Maximum Speed].

This page is intentionally left blank.

12. INSTRUMENT-RELATED DISPLAYS

With connection of appropriate sensors, this equipment provides three types of specialized displays:

Instrument display: This display provides conventional navigation and environment data. Analog and digital displays, highway display, NAVpilot data, etc. can be shown. The display can be programmed to a full screen or three-way split screen.

CZone display: This display offers, in a full screen display, control of the Power Products' CZone equipment (shipboard power management system) connected in the NavNet network.

Yamaha engine status display: This display provides engine information about compatible Yamaha engines, in a full screen display.

12.1 How to Show the Instrument Display

Set the instrument display on the Home screen referring to subsection 1.7.1. Tap the instrument display icon to show the instrument display.

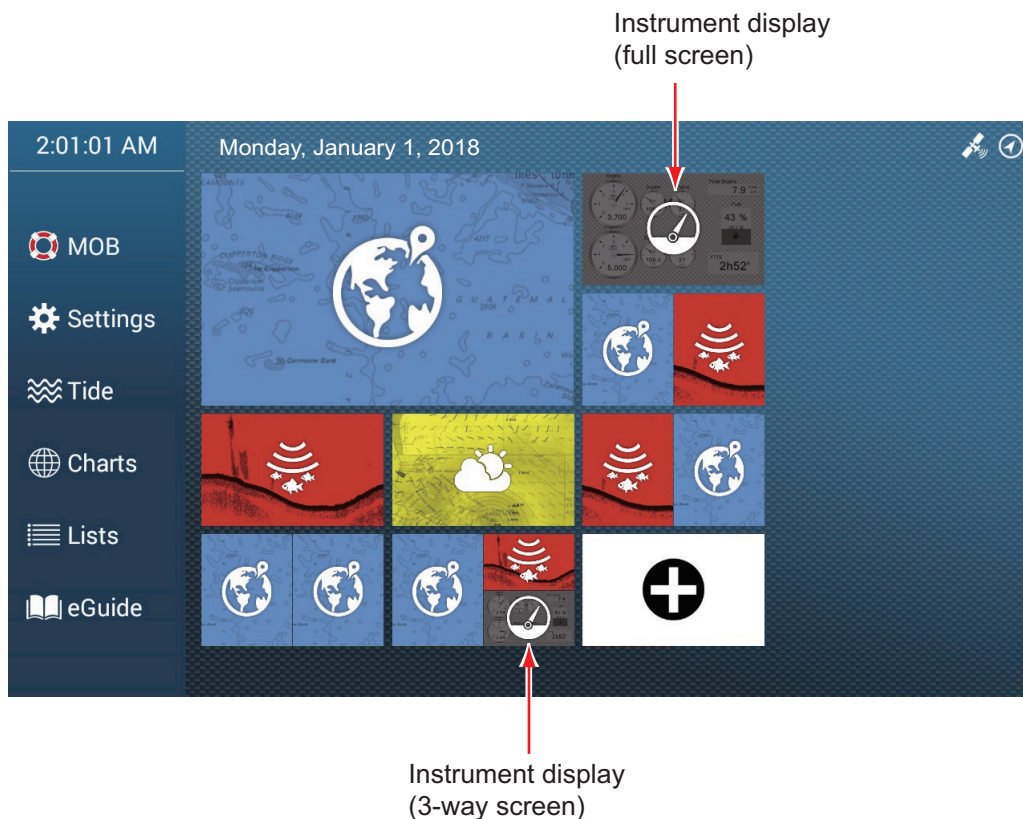

12.2 Instrument Displays

This section provides examples of the instrument displays, in their default arrangements.

The background color of the instrument displays can be selected to black or white. The illustrations in this chapter use the black background.

12.2.1 Full-screen instrument displays

Sailing instrument display

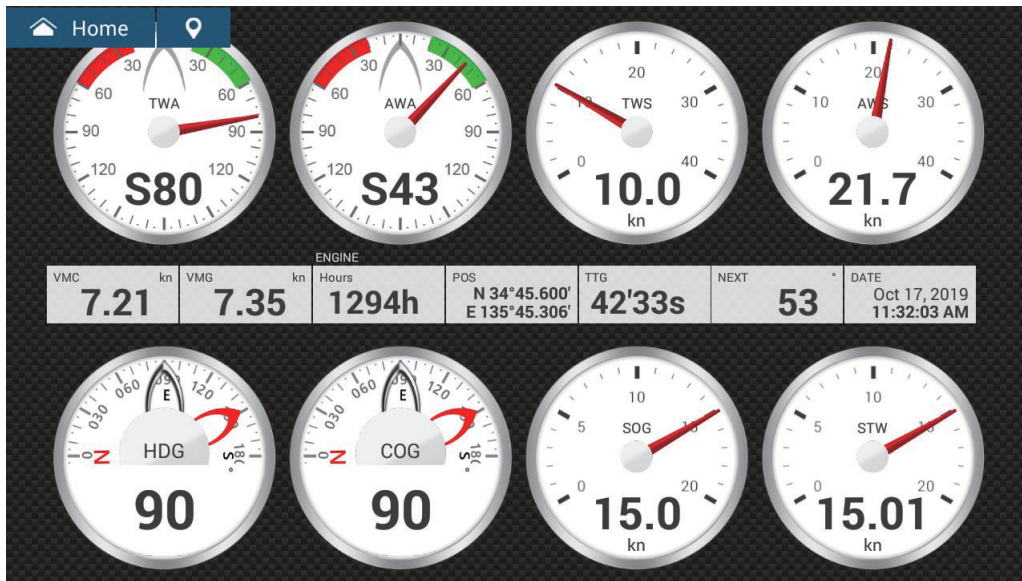

Cruising instrument display

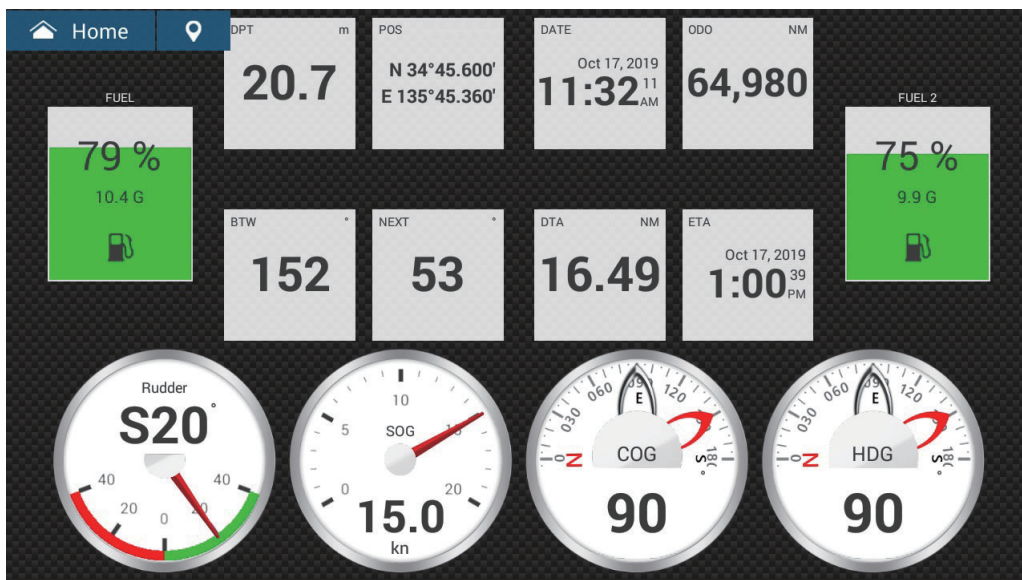

Single outboard instrument display

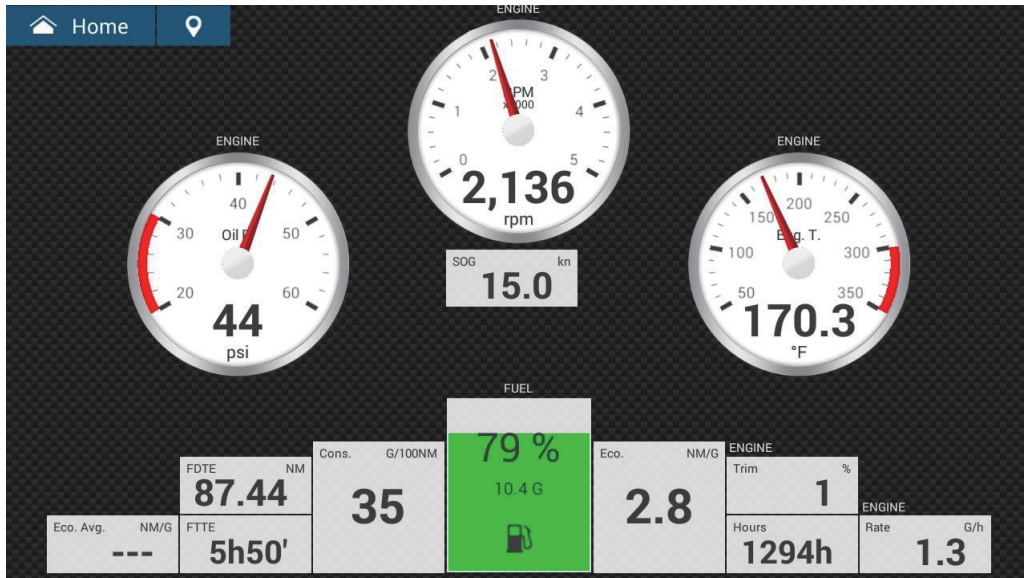

Twin outboard instrument display

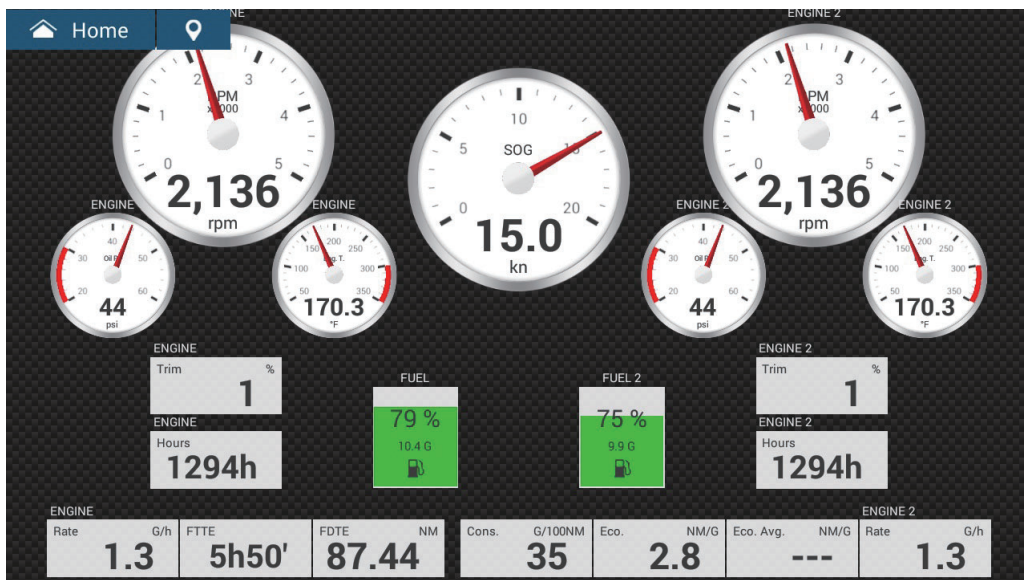

Triple outboard instrument display

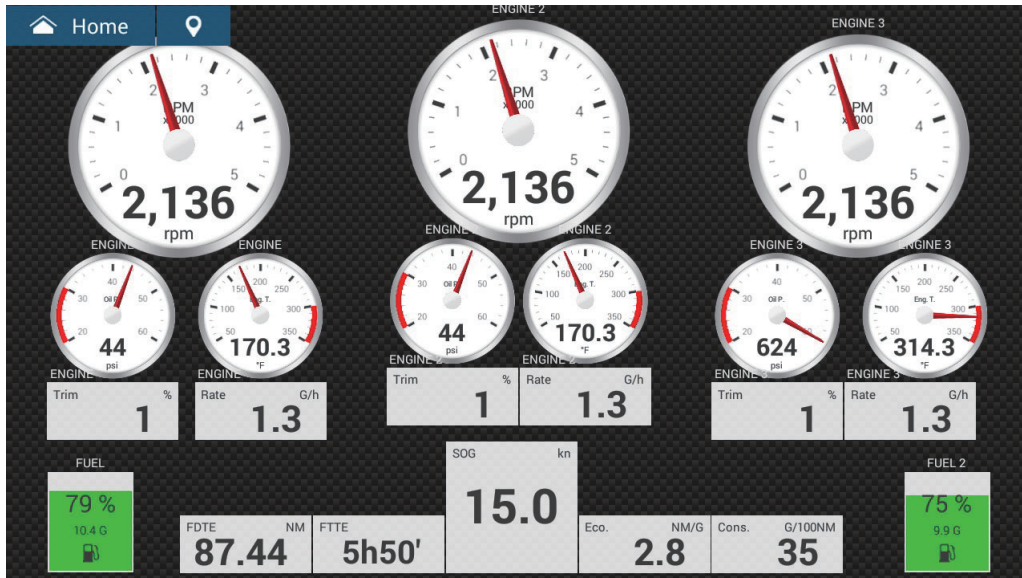

Quad outboard instrument display

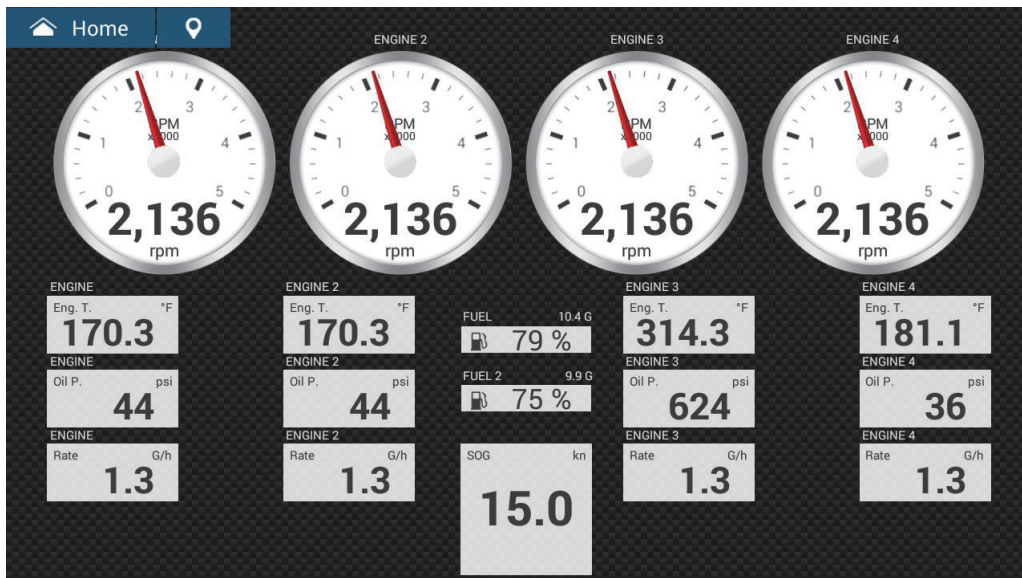

Single inboard instrument display

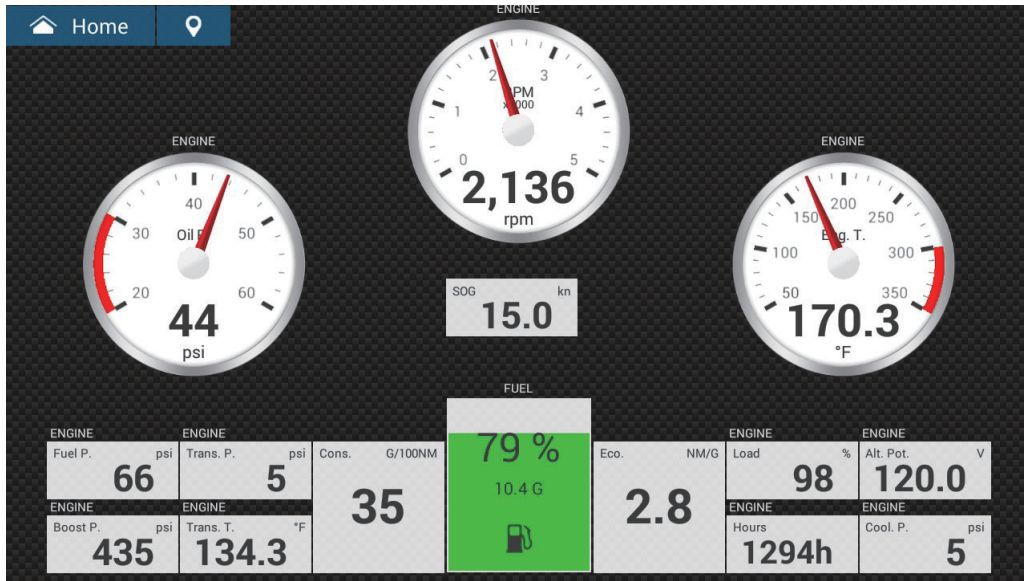

Highway instrument display

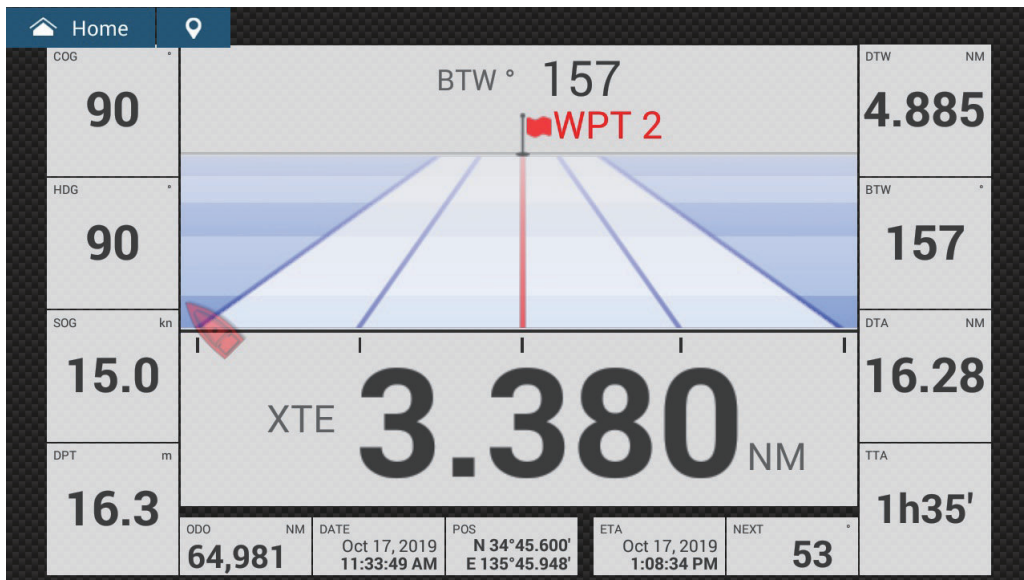

12. INSTRUMENT-RELATED DISPLAYS

Twin inboard instrument display

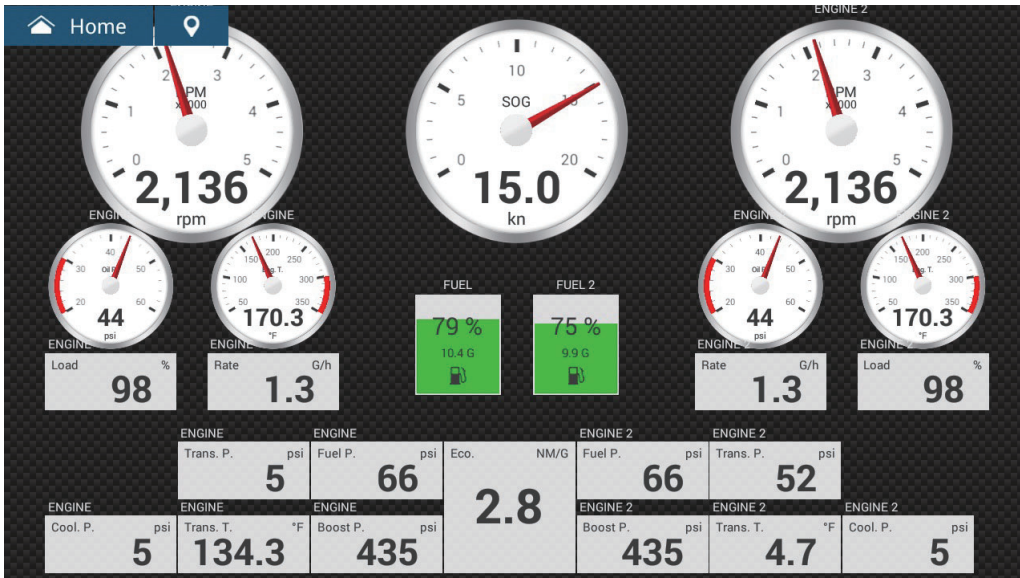

12.2.2 Three-way, four-way split screen instrument display

Navigation instrument display

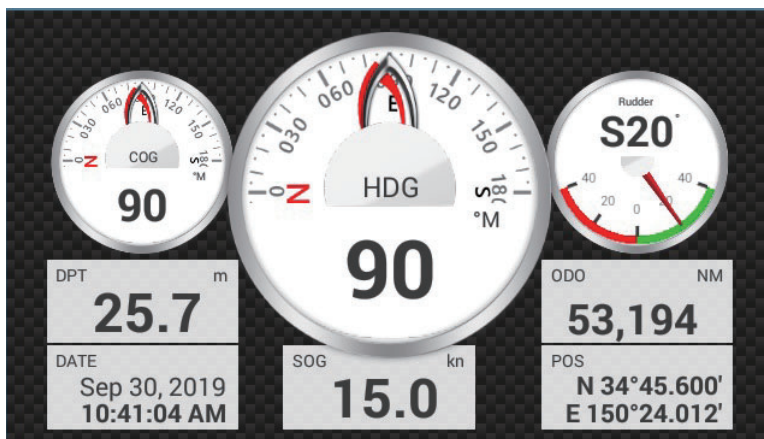

Graphs instrument display

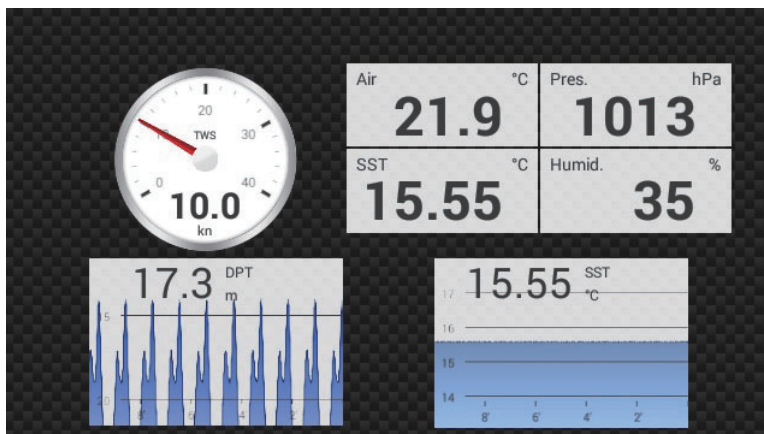

Environment instrument display

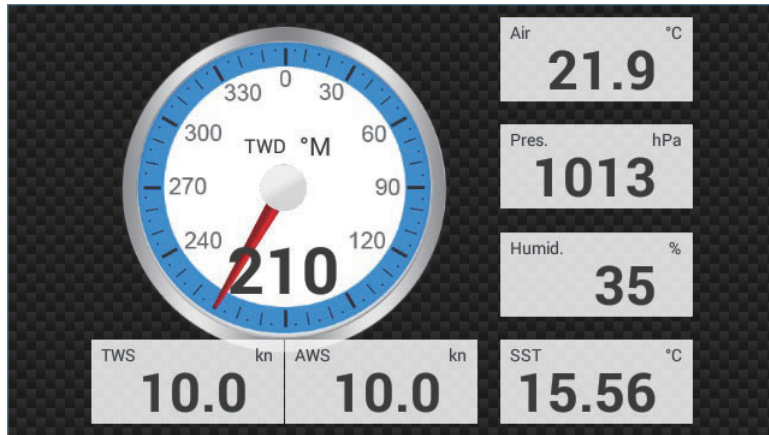

Wind instrument display

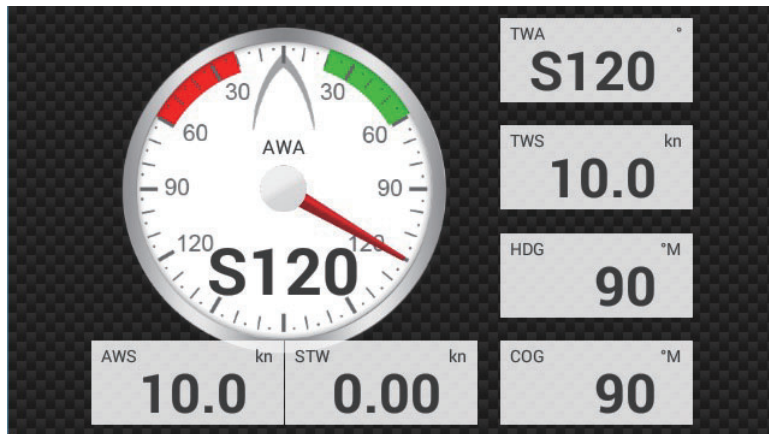

Numeric instrument display



12. INSTRUMENT-RELATED DISPLAYS

Highway instrument display

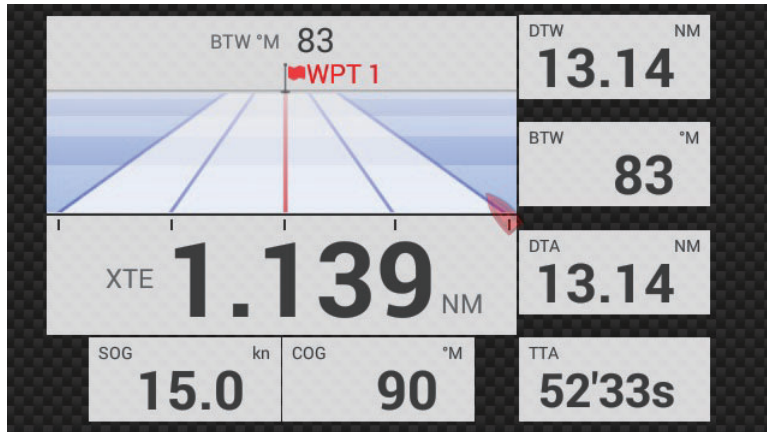

NAVpilot instrument display

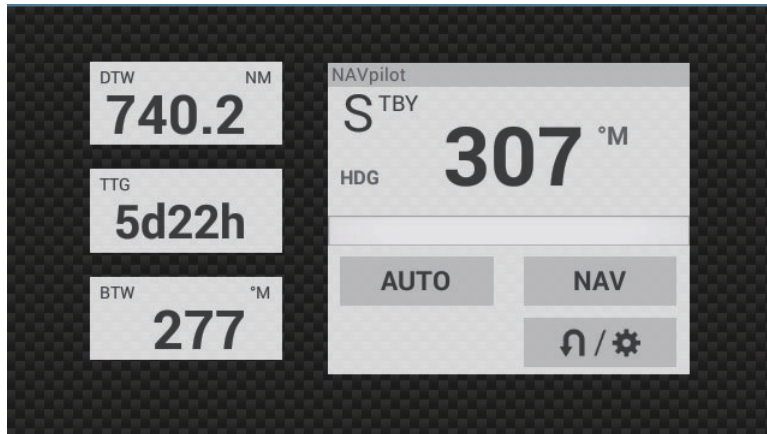

Single engine instrument display

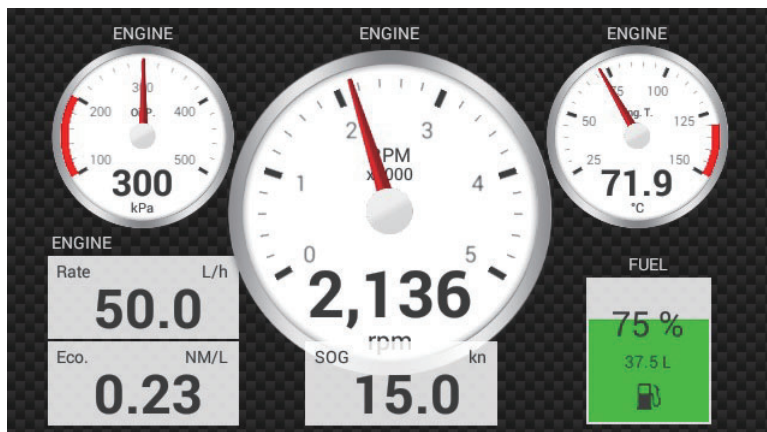

Twin engines instrument display

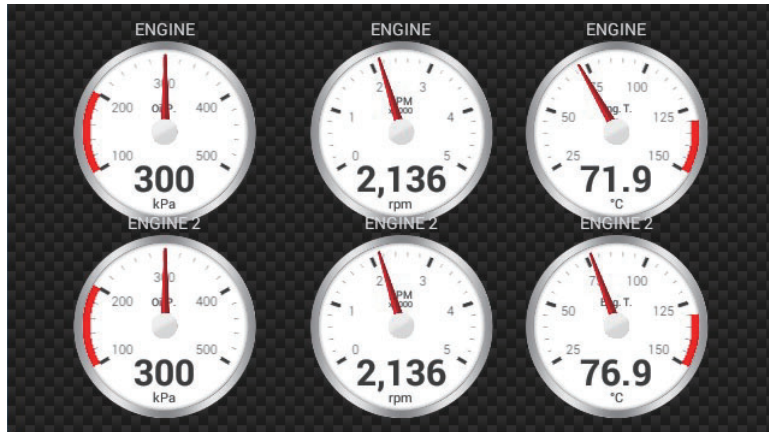

Triple engines instrument display

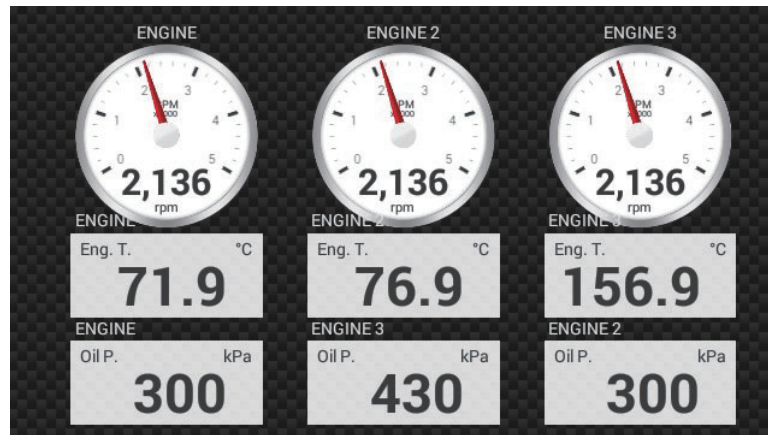

Tank instrument display

The tank display shows the fuel level in both analog and digital formats. The analog display indicates an increase or decrease in fuel level and changes color according to the percentage of fuel remaining.

Green: 10% - 100% Red: 0% - 10%

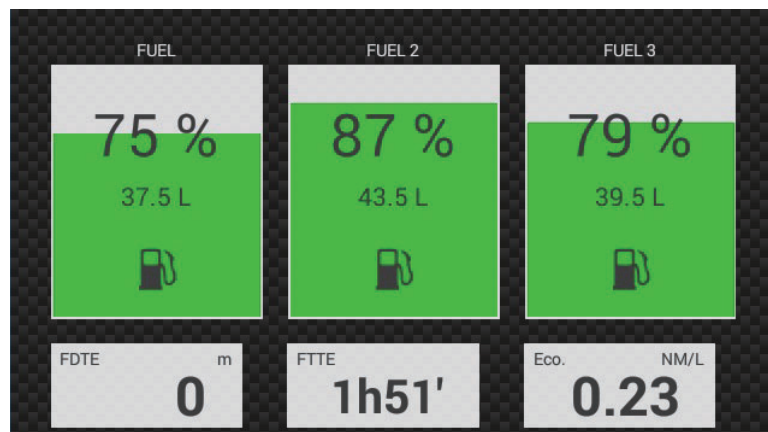

12.2.3 How to switch between instrument displays

Note: The data that can be displayed depends on the your system configuration.

Full-screen display

There are nine default full-screen displays, Sailing, Cruising, Single, Outboard, Twin Outboard, Triple Outboard, Quad Outboard, Single Inboard, Highway?, and Twin Inboard.

You can show the full-screen instrument display by these two methods.

- Swipe the screen leftward or rightward. The name of the currently shown display appears at the center of the screen.
- Tap the screen to show the instrument screen selection window, shown right.

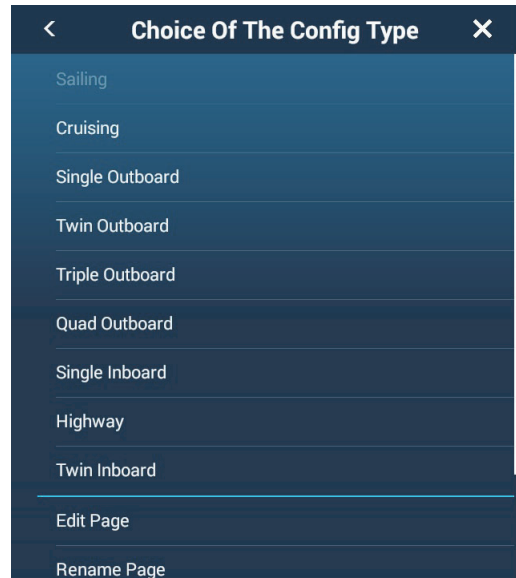

Three-way, four-way split screen

The default display screens in the 3-way, 4-way split screen are [Navigation], [Graphs], [Environment], [Wind], [Numeric], [Highway], [NAVPilot], [Single Engine], [Twin Engines], [Triple Engines], and [Tank]. The availability of a display depends on your system configuration.

You can switch between the displays by the following two methods:

- Swipe the screen leftward or rightward. The name of the currently shown display appears at the center of the screen.
- Tap the screen to show the instrument screen selection window, shown right.

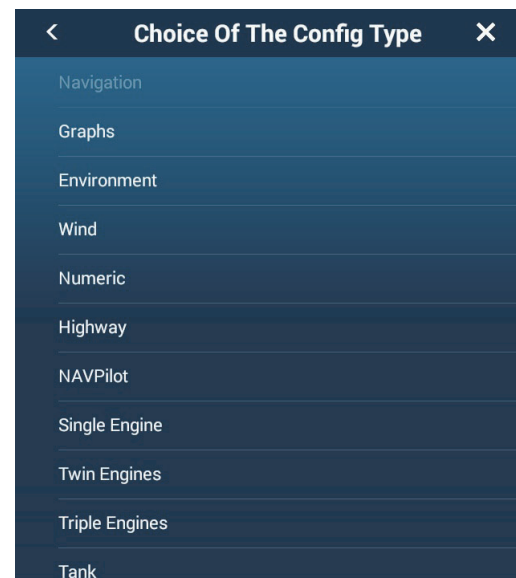

12.3 How to Edit the Instrument Displays

The instrument displays are fully customizable. You can edit the displays as follows:

- Remove an indication from a display
- Add an indication to a display
- Rearrange the indications in a display
- Rename a display
- Delete a display
- Remove a display
- Add a custom display

Note: To restore the default instrument displays, go to the Home screen, then tap [Settings]→[Initial Setup]→[Graphic Instruments Setup]→[Reset Instrument Pages]→[OK]. All default displays are restored and any custom displays are deleted.

12.3.1 How to prepare for editing

To start the editing process, tap anywhere on an instrument display to show the pop-up menu, then tap [Edit Page] on the menu. A white line circumscribes each indication in the display, as shown in the figure below. Edit the display referring to the procedures in the coming sections. To save your changes, tap anywhere on the instrument display to show the pop-up menu, then tap [End Edit] on the menu.

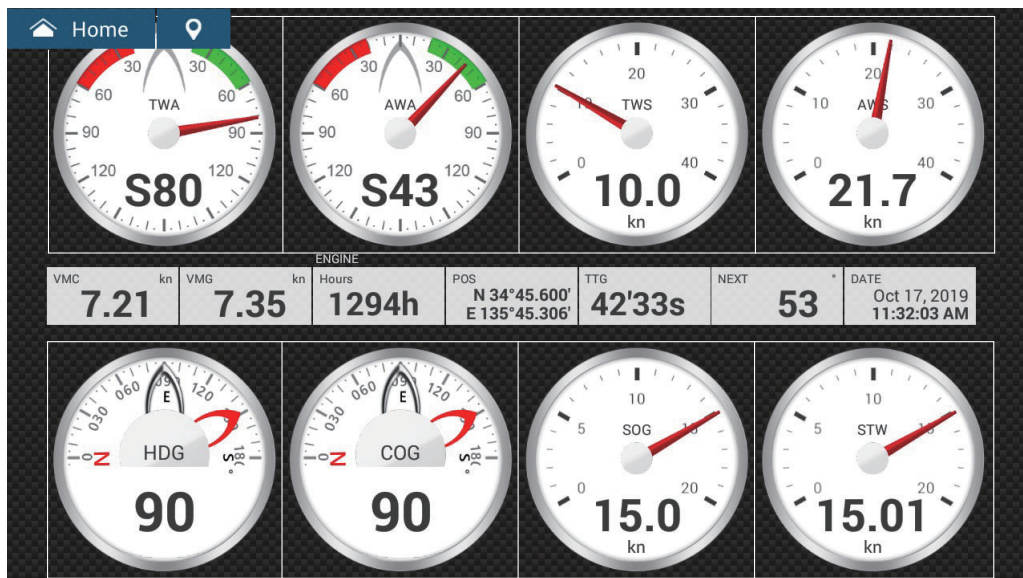

12.3.2 How to rearrange the indications in an instrument display

Drag and drop the indications to your liking.

12.3.3 How to edit, remove an indication in an instrument display

1. Prepare the display for editing as shown in section 12.3.1.
2. Tap the indication to process to show the [Edit Instrument] pop-up menu.

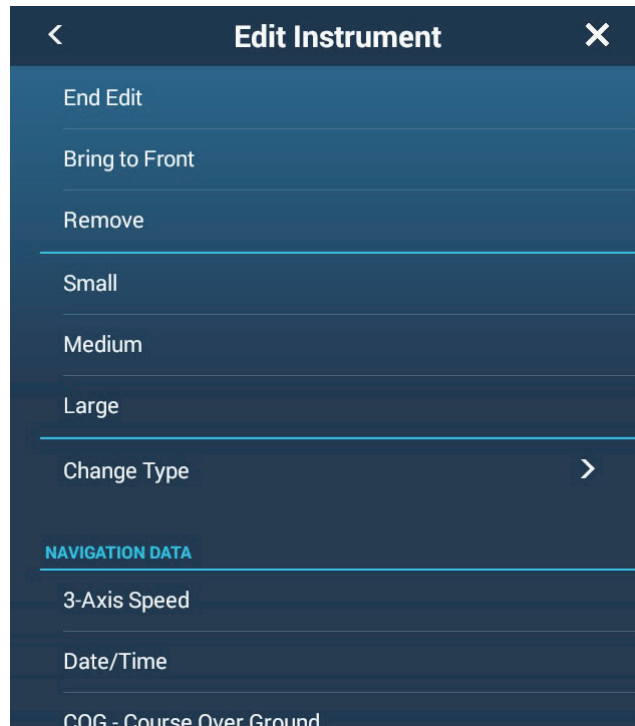

3. Do one of the following depending on your objective:
 - **Bring to front:** If two indications are occupying the same location, you can select one to bring to the front. Tap the indication to bring to the front, then tap [Bring to Front].
 - **Remove:** Tap [Remove].
 - **Change the indication:** Tap required data in the [NAVIGATION DATA], [ROUTE INFORMATION], or [WIND AND WEATHER].
 - **Change the size:** Tap [Small], [Medium], or [Large] as appropriate.
 - **Change the indication type:** The available indication types are [NAVIGATION DATA], [ROUTE INFORMATION], [WIND AND WEATHER], and [ENGINE].

- **Change the format:** Tap [Change Type] to show the pop-up menu shown below. Choose the format and size.



The format choices are [GRAPHIC]^{*1}, [NUMERIC]^{*2}, [GRAPH], [TANK], [HIGHWAY], and [NAVPILOT]^{*3} and the available sizes are [Small], [Medium], and [Large].

*1 Graph cannot be displayed for engine or tank data.

*2 Displayed with connection of a tank sensor and [MANUAL FUEL TANK] is set to [ON]. See subsection 12.5.1

*3 Requires connection of FURUNO NAVpilot.

- **Change graph plotting time (horizontal axis):** Tap [Plot Period]^{*} to change the time over which the graph's data is plotted.
* Depending on the display time, the number of data points displayed on the graph may be reduced, and the graph may be coarse.
- **Change graph plotting range (vertical axis):** Tap [Plot Range Value] to change the range for the data display in the graph. Tap [✓] to finish and close the keyboard.

12.3.4 How to add an indication to an instrument display

1. Prepare the display for editing as shown in "How to prepare for editing" on page 12-11.
2. Tap an unoccupied position on the instrument display to show the [Add Instrument] pop-up menu.

Note 1: If there is no space available, remove an unnecessary indication following the procedure in "How to prepare for editing" on page 12-11.

Note 2: You can show a maximum of 24 displays in the full screen instrument display; 10 displays in a split-screen display.

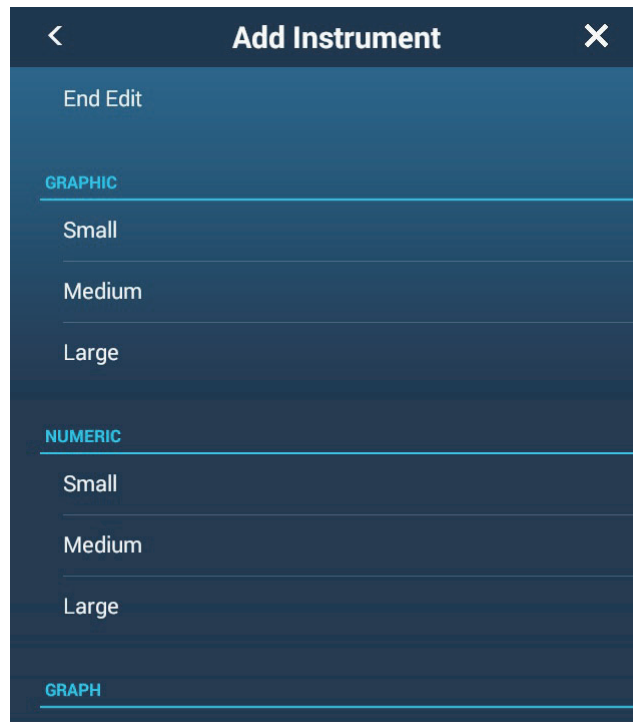

3. Tap a size in the applicable section.
4. Tap the added instrument display to change its data. See section 12.3.3.

12.3.5 How to rename an instrument display

1. Show the instrument display that you want to rename.
2. Tap the display to show the [Choice of Config Type] pop-up menu.
3. Tap [Rename Page] to show the software keyboard.
4. Enter new name (maximum of 20 alphanumeric characters), then tap [✓].

12.3.6 How to remove an instrument display

Tap the instrument display to show the pop-up menu, then tap [Remove Page] on the menu.

1. Show the instrument display that you want to remove.
2. Tap the display to show the [Choice of Config Type] pop-up menu.
3. Tap [Remove Page]. You are asked if you are sure to remove the page.
4. Tap [OK] to remove the page.

12.3.7 How to add an instrument display

Full screen, three-way split and four-way split screens are preset in this equipment. If the displays do not meet your requirements, you may add custom displays as necessary. You can have 10 full screen displays, and 10 3-way/4-way split screens.

1. Tap the instrument display to show the [Choice of Config Type] pop-up menu.
2. Tap [Add Page] to show the software keyboard.
Note: If you have reached the capacity for the screen configuration selected, [Add Page] is grayed out. Remove an unnecessary page referring to "How to edit, remove an indication in an instrument display" on page 12-12.
3. Enter a name for the page then tap [✓]. A blank page appears.
4. Tap the blank page to show the [Add Instrument] pop-up menu.
5. Tap a size in the applicable section
6. Repeat steps 4 - 5 to add other items.
7. After you have added all items required, tap the screen to show the [Add Instrument] pop-up menu, then tap [End Edit] to finish.
The page name appears in the [Choice of The Config Type] pop-up menu.
8. if you need to rearrange the data, see section 12.3.2 and section 12.3.3.

12.3.8 SC-33/SCX-20 3-axis speed display

With connection of a SC-33/SCX-20 Satellite Compass™ in the network, a dedicated 3-axis speed display data box can be shown in the data area.

This function requires input of the PGN data sentence 130578 (Vessel Speed Components).

Referring to section 12.3.3 and section 12.3.4, tap [3-Axis Speed].

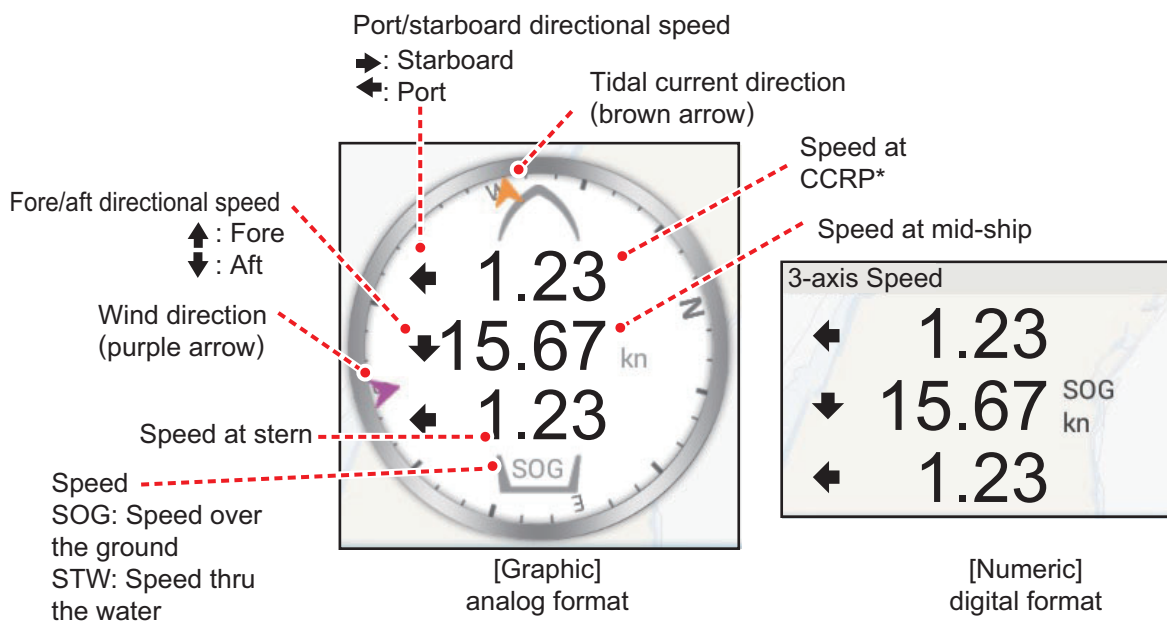

*CCRP (Consistent Common Reference Point) is determined at installation, and is either the bow, transducer location or center of vessel.

12.4 Instrument Theme

The instrument theme is available in black or white. To change the theme, go to the Home screen and tap [Settings]→[General]. Set [Instrument Theme] to [Black] or [White].



Black

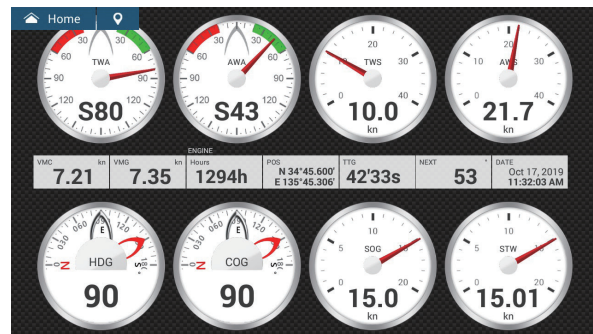

White

12.5 Fuel Management System

This equipment can calculate the remaining fuel from the total fuel and the fuel consumption rate. This function requires the NMEA 2000 sentence PGN127489 (Engine Fuel Rate).

Note: The remaining fuel calculation is for reference purposes. Do not use the results for navigation planning or emergency purposes. During an entire voyage, select one NavNet Ztouch3 unit for the calculation at start-up. The calculation of remaining fuel is not done when the unit is powered off.

12.5.1 How to manually enter fuel tank capacity

1. From the Home screen, tap [Settings]→[Initial Setup].
2. At [Total Fuel Capacity], enter your vessel's total fuel capacity.
3. Set the flipswitch of [Manual Fuel Management] to [ON].
4. Tap [OK] to finish.

12.5.2 How to check remaining fuel amount

You can check remaining fuel and update fuel amount from the [Slide-out] menu.

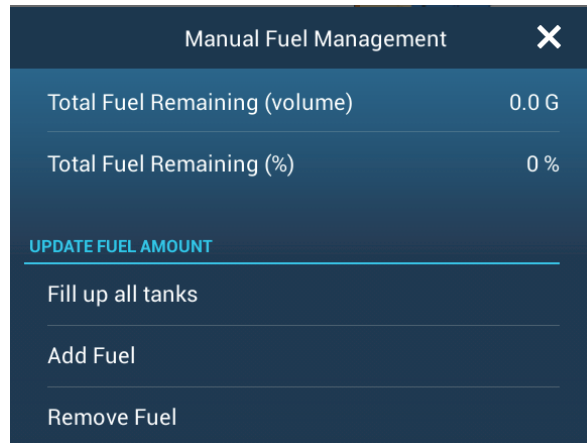

How to fill up all tanks

1. Tap [Fill up all tanks] on the [Manual Fuel Management] pop-up menu. You are asked to confirm that you want to fill up all tanks.
2. Tap the [OK] button.
3. Tap the close button on the pop-up menu to finish.

How to add fuel

1. Tap [Add Fuel] on the [Manual Fuel Management] pop-up menu. You are asked to confirm that you want to fill up all tanks.
2. Enter the amount of fuel to add, then tap [✓].
3. Tap the close button on the pop-up menu to finish.

12.6 CZone

The NavNet TZtouch3 can control Power Products' CZone equipment connected in the NavNet network. CZone is a shipboard power management system.

This equipment controls [CZone Control], [CZone Modes] and [CZone Monitoring].

- **CZone Control:** Controls the power of individual CZone equipment.
- **CZone Modes:** Controls the power of multiple CZone equipment.
- **CZone Monitoring:** Shows temperature, pressure, fuel tank and battery state of CZone equipment.

The table below shows the points of control of each CZone system.

System name	Instrument display	Data area	Slide-out menu
CZone Control	Yes	No	Yes
CZone Modes	Yes	Yes	Yes
CZone Monitoring	Yes (display only)	Yes (display only)	No

12.6.1 How to use CZone

After confirming the following two items, set up your NavNet system to use CZone.C

- This equipment is connected to the CZone system and NavNet network by NMEA 2000 interface.
- CZone equipment have been properly set.

How to add/edit CZone pages

Add or edit CZone pages in the following instances:

- First use of CZone
 - Setting changed at the CZone system
1. From the Home screen, tap [Settings]→[Initial Setup]→[Graphic Instruments Set-up]→[Add Default CZone Pages]. You are asked if it is OK to add or edit CZone pages.
 2. Tap the [OK] button.
 3. Tap the close button on the title bar to close the menu.

About the DIP switches

For the serviceman. Do not change the settings.

12.6.2 CZone control

Display and operations from the instrument display

1. On the Home screen, tap the instrument display icon.
If there is no instrument display icon, see section 1.7.1 for how to add the icon.
2. Tap the display screen, to show the [Choice of the Config Type] pop-up menu.

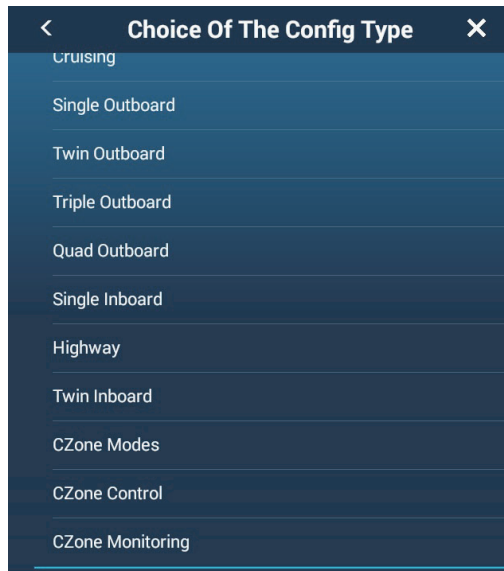

3. Tap [CZone Control] to show the [CZone Control] screen. Use [ON], [OFF], [←], [↑], [↓], [→] to control CZone equipment.

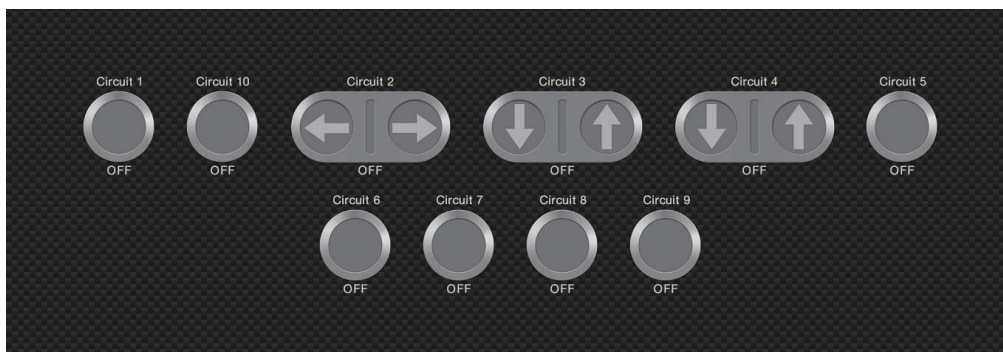

CZone Control screen (example)

12. INSTRUMENT-RELATED DISPLAYS

You can customize the [CZone Control], [CZone Modes] and [CZone Monitoring] screens. See section 12.3.



Customized screen (example)

Display and operations from the Slide-out menu

1. Open the Slide-out menu.
2. Tap [CZone Control] to show the following menu.

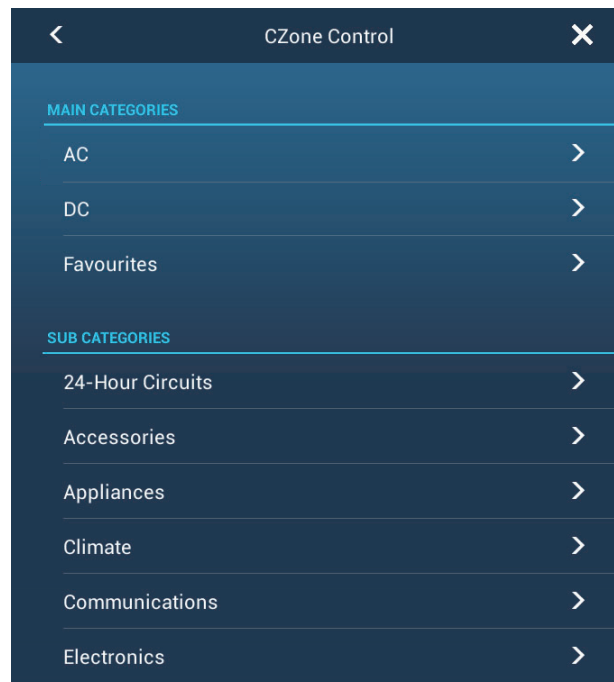

3. Swipe up or down or tap ">" to select CZone equipment.
4. Use [ON], [OFF], [←], [↑], [↓], [→] to control CZone equipment.
5. Tap the close button on the title bar to close the menu.

12.6.3 CZone modes

Display and operations from the instruments display

1. On the Home screen, tap the instrument display icon. If there is no instrument display icon, see section 1.7.1 for how to add the icon.
2. Tap the screen to show the following pop-up menu.

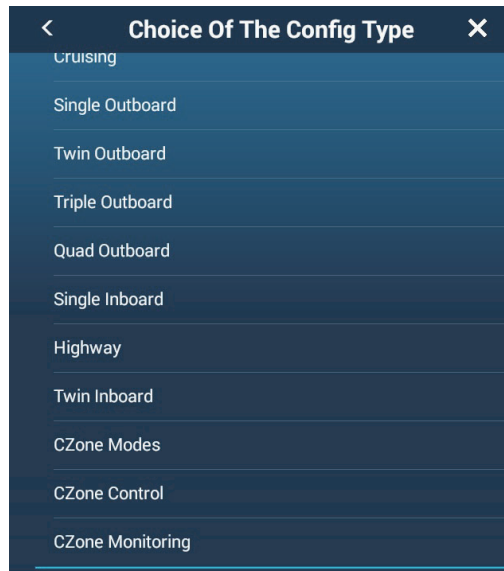

3. Tap [CZone Modes] to show the following screen. Tap the [ON], [OFF] button to operate a CZone equipment.

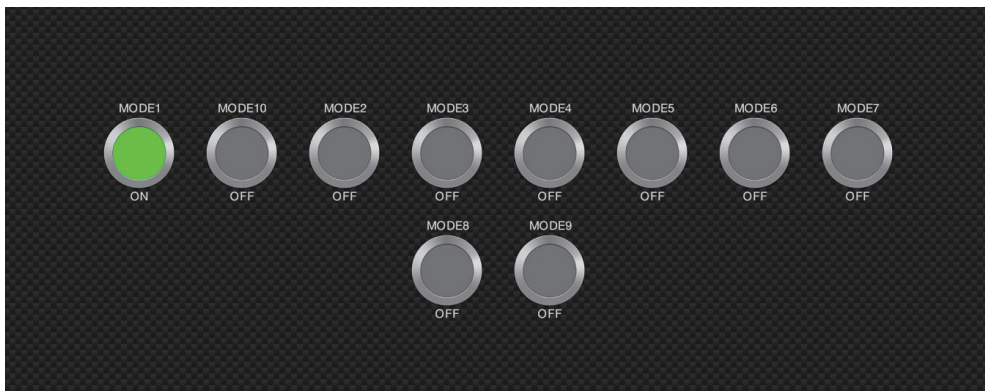

12. INSTRUMENT-RELATED DISPLAYS

You can customize the [CZone Control], [CZone Modes] and [CZone Monitoring] screens. See section 12.3.



Customized screen (example)

4. Tap the close button on the title bar to close the menu.

Display and operations from the data area

1. Show the data area.
2. Long-tap the data box to show the [Edit NavData] menu.
3. Tap a vacant area in the data area to show the [Add Nav Data] menu.

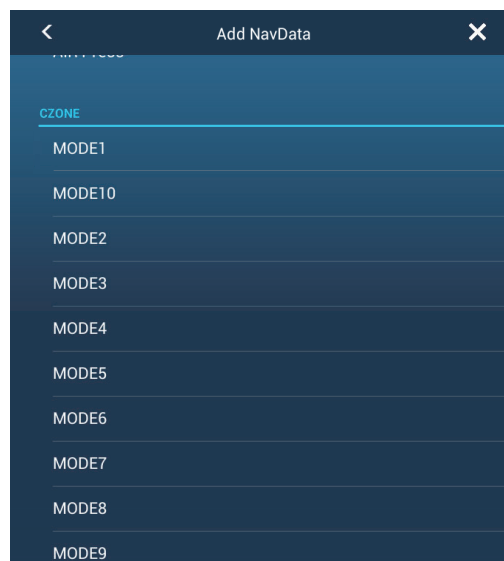

4. Tap the display mode that you want to add. The selected item appears at the bottom of the data area.

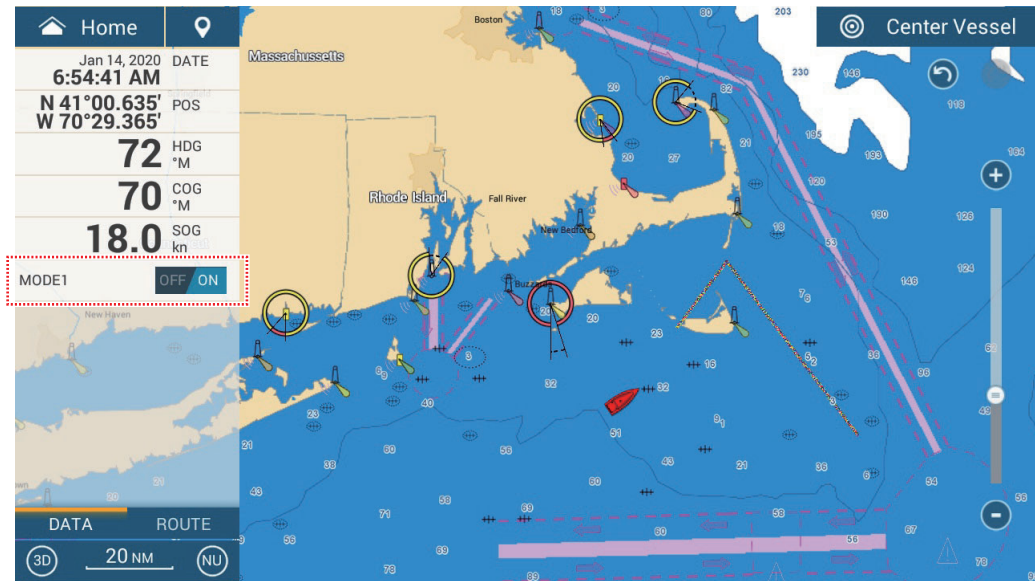

5. Tap the added item to control corresponding CZone device.

Display and operations from the Slide-out menu

1. Open the Slide-out menu.
2. Tap [CZone Modes] to show the following menu.
A list of CZone modes appear.

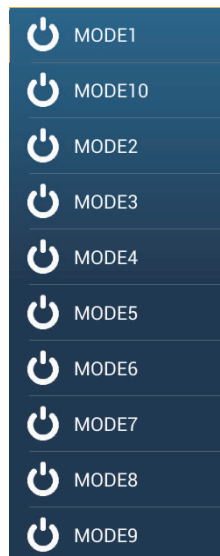

3. Tap the mode to use.
4. Tap the close button on the title bar to close the menu.

12.6.4 CZone monitoring

Display on the instruments display

1. On the Home screen, tap the instrument display icon. If there is no instrument display icon, see section 1.7.1 for how to add the icon.
2. Tap the screen to show the following pop-up menu.

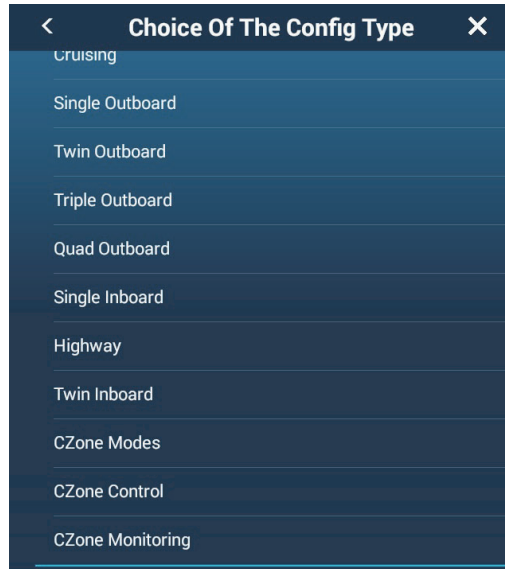

3. Tap [CZone Monitoring] to show the following screen.

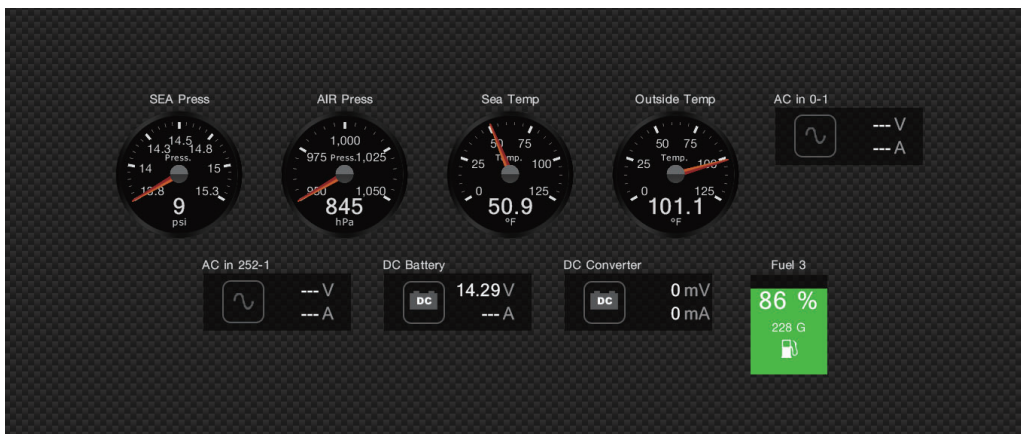

You can customize the [CZone Control], [CZone Modes] and [CZone Monitoring] screens. See section 12.3.

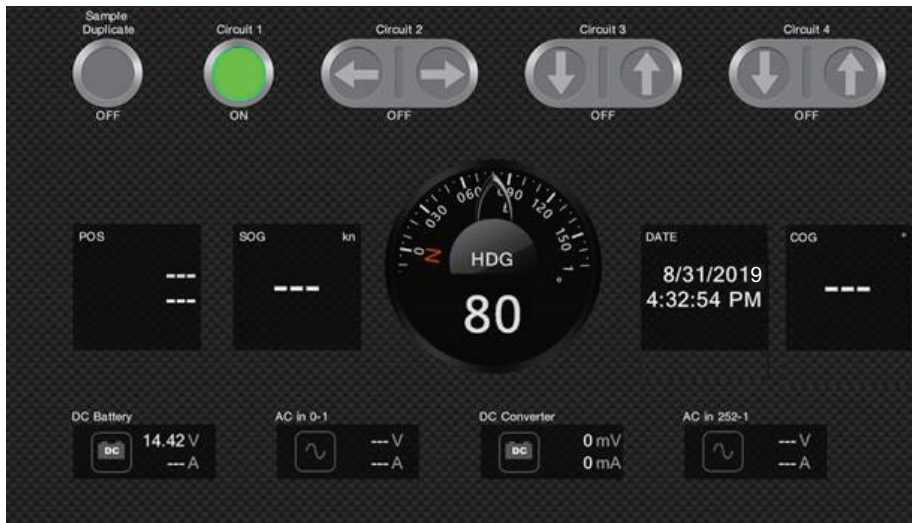

Customized screen (example)

4. Tap the close button on the title bar to close the menu.

Display and operations from the data area

1. Show the data area.
2. Tap a vacant area in the data area to show the [Add Nav Data] menu.
3. Tap the display mode to add. The selected item appears at the bottom of the data area. In the example below, water temperature data is shown. To add or delete data, see section 1.9.2 (add data) or section 1.9.4 (delete data).

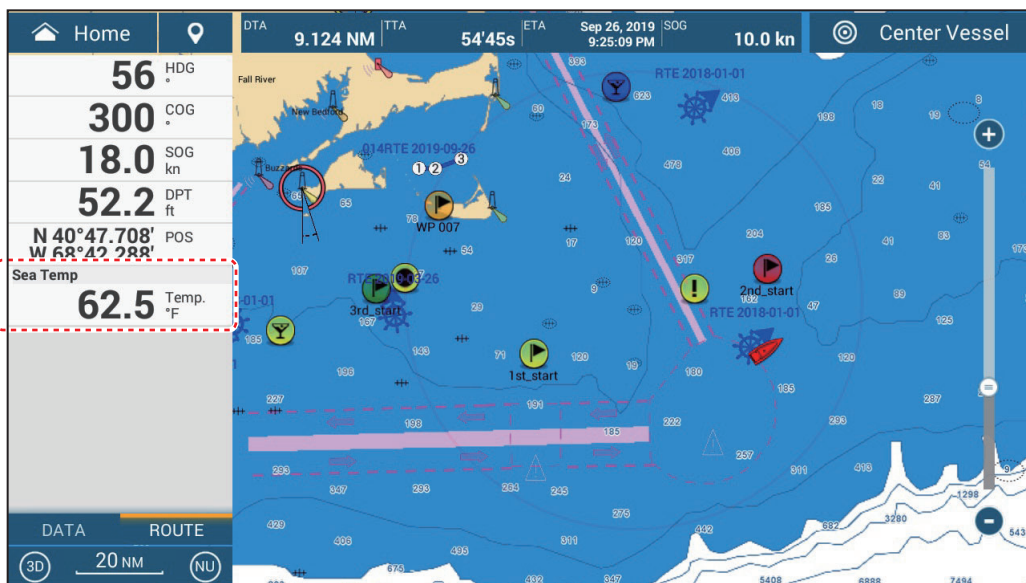

12.7 Yamaha Engine Status Display

Overview

When interfaced with a Yamaha outboard engine(s) compatible with Command Link[®], Command Link Plus[®], and Helm Master or Helm Master EX (HDMI I/F not available with TZT9F or TZT12F), the NavNet TZtouch3 can display engine information on the full-screen or quarter screen. All setups and indications of Yamaha engine gauges that are available with the dedicated Yamaha displays can be shown on the NavNet TZtouch3.

There are two types of displays, the **engine combo display**, and the **boat status display**.

The **engine combo display** shows critical engine system data, including shift position, engine RPM, boat speed, engine trim level, available fuel in gallons, fuel level (up to six tanks), fuel flow, fuel economy and other vital engine functions such as oil pressure, water pressure and battery voltage.

The **boat status display** shows provides important information such as trip distance, speed, fuel flow, fuel economy, gallons used, rudder info, depth, and other information.

Yamaha engine information can also be shown on the conventional instrument display, using the NMEA 2000 PGN sentences 127488 (Engine Parameters, Rapid Update) and 127489 (Engine Parameters, Dynamic).

Set the number of engines and other engine-related information on the [YAMAHA ENGINE SETUP] menu, in the [Initial Setup] menu. For details, see the NavNet TZtouch3 installation manual.

Main differences between Master Helm and Master Helm EX

	Helm Master	Helm Master EX
No. of engines	Multiple (four max.)	Single
Steering system	Electronic+hydraulic	Electronic+electric
Shift throttle	Electronic	Electronic
Joystick	Standard	Option
Fish point, Drift	Yes	Yes
Stay point	Yes	No
Autopilot	No	Yes

Helm Master EX application levels

The features available with the Helm Master EX depend on the application level, selected at the time of purchase.

Function	Level1	Level2	Level3	Level4
Single Lever	●	●	●	●
Speed Control	●	●	●	●
Trim Assist	●	●	●	●
Center Engine	●	●	●	●
Neutral Hold	●	●	●	●
Pattern Shift	●	●	●	●
Adjustable/Variable Lock-to-Lock		●	●	●
Adjustable/Variable Steering Function		●	●	●
Heading Hold			●	●
Course Hold			●	●
Track Point			●	●
Pattern Steer (Zigzag and Concentric Spiral)			●	●
Autopilot with Waypoint Arrival and Joystick Control				●
Set Point [®] Features Fish Point [®] , Drift Point [®] , Stay Point [®]				●
Full Joystick Maneuverability				●

Helm Master EX usage notices

- Only one HDMI screen can be set for the split screen display.
- If the system does not recognize the HDMI I/F, the HDMI display icon will not appear on the home screen.
- If the HDMI video is not input due to a wiring problem, the HDMI screen will be blank (blue screen).
- If the HDMI I/F is on the network, and an HDMI camera is selected as HDMI input, the camera image cannot be seen on any screen in the network, including the MFD to which the HDMI camera is connected. In other words, the HDMI I/F and HDMI camera cannot be used at the same time.
- If the HDMI I/F is on the network, the Gateway screen can only be displayed on the MFD to which the HDMI I/F is connected. Conversely, using only the Gateway screen and Yamaha engine CL5 or CL7, engine information can be displayed and the engine operated on all MFDs.

12.7.1 How to show the display

Add the Yamaha engine status display icon to the Home screen (if it has not already been done), referring to section 1.7.1. Tap the Yamaha engine status display icon on the Home screen to show the display.



HDMI I/F connection icon (green)
(TZT16F/19F)

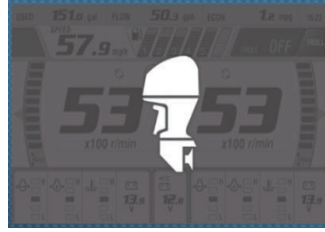

N2K Gateway connection icon (gray)
(TZT9F/12F/16F/19F)

Connection type and function availability

	HDMI I/F	N2K Gateway
Operation	Remote control only	Display switching, display setting, troll mode, etc.
Applicable model	TZT16F/TZT19F	TZT9F/12F/16F/TZT19F
Applicable screen division	Full screen, 1/4 screen	Full screen, 1/4 screen

12.7.2 Display examples

Each display type is divided into three sections: upper, middle and lower. The error message area at the top of a display shows engine error messages.

The display can be shown on the full screen and 1/4 screen. The example displays here are the full screen displays.

For detailed descriptions of the displays, see the Operator’s Manual for the Yamaha engine.

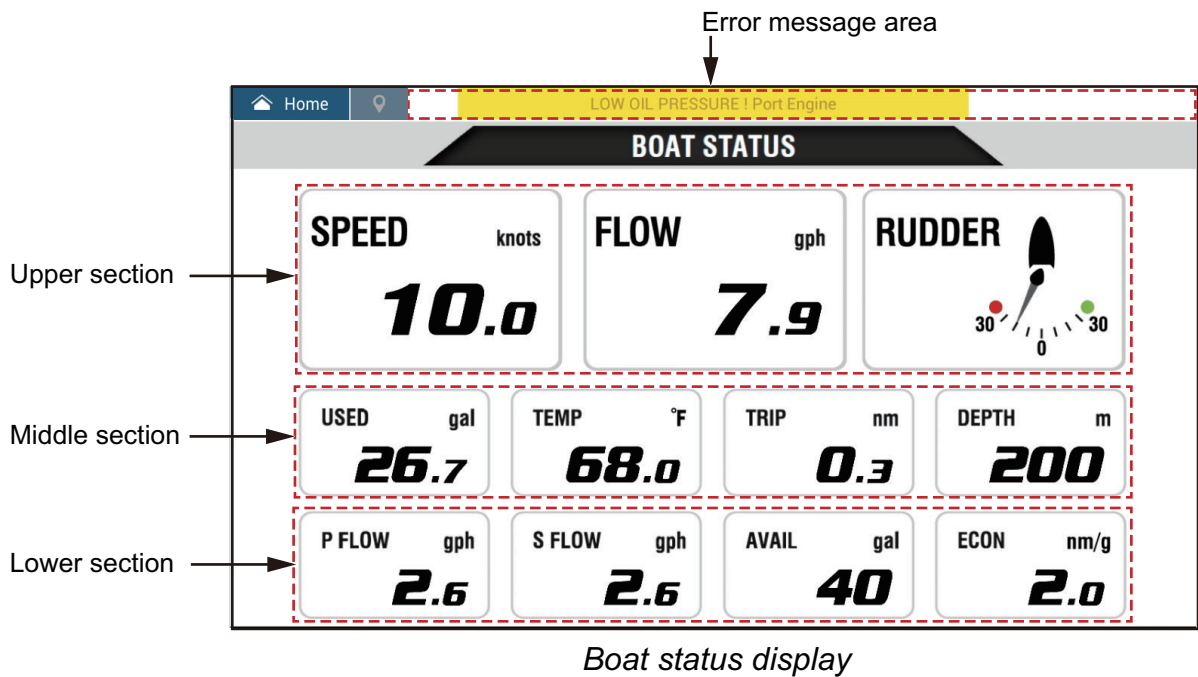
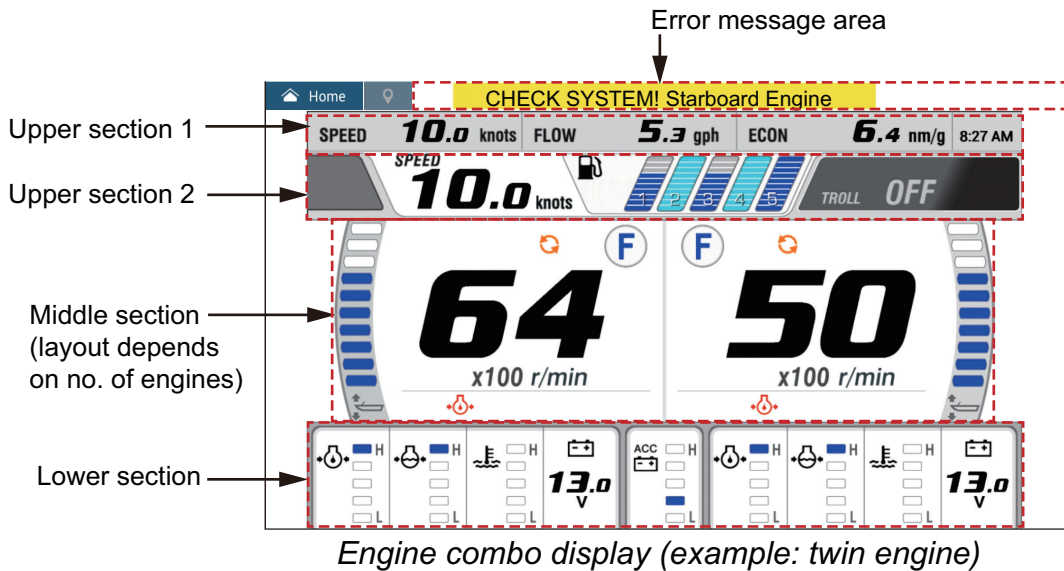

12.7.3 How to switch between displays

There are two methods by which you can switch displays.

Tap screen: Tap the screen to show the pop-up window, then tap the indication in the window, as in the example below.

Swipe screen: Swipe the screen from bottom up or top down.

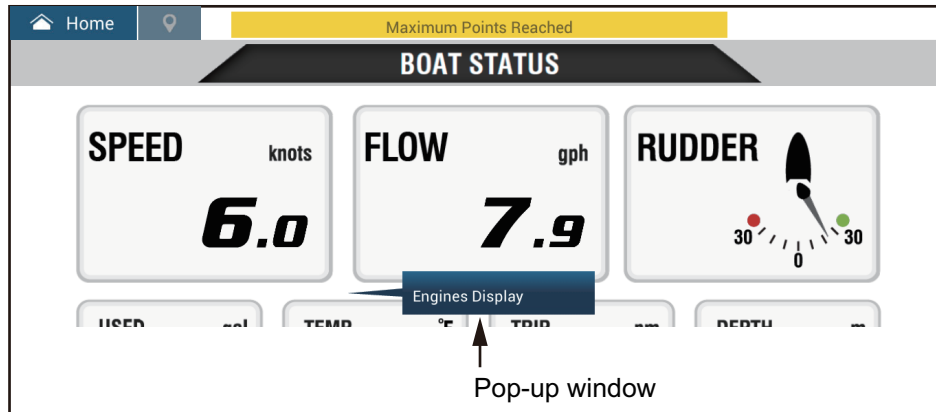

12.7.4 How to select the data to display in a data box

Tap a data box in a Yamaha engine display, and a pop-up menu appears. Tap the desired data on the pop-up menu to show it in the selected data box. The example below shows the pop-up menu available with the boat status display.

For the engine combo display, only the data boxes in the lower and middle sections can be changed.

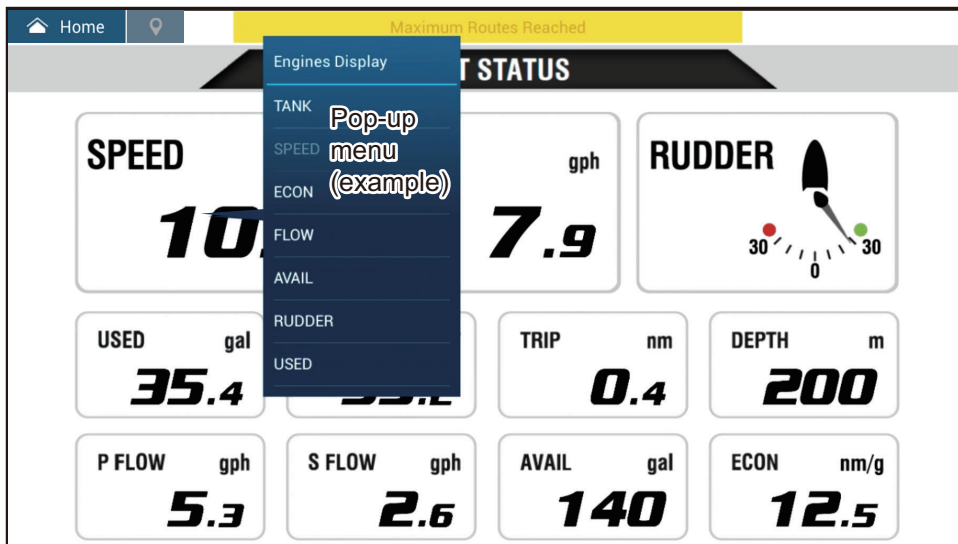

12.7.5 Troll mode

The Troll mode is also integrated into the display, allowing you to control trolling speed from the engine combo display. Tap the Troll mode ON switch at the top right corner on the engine combo display to activate the mode. The Troll mode operation panel appears at the bottom of the display. Use the controls on the panel to operate the Troll mode, referring to the illustration below.

For details, see the Operator's Manual for the Yamaha engine.

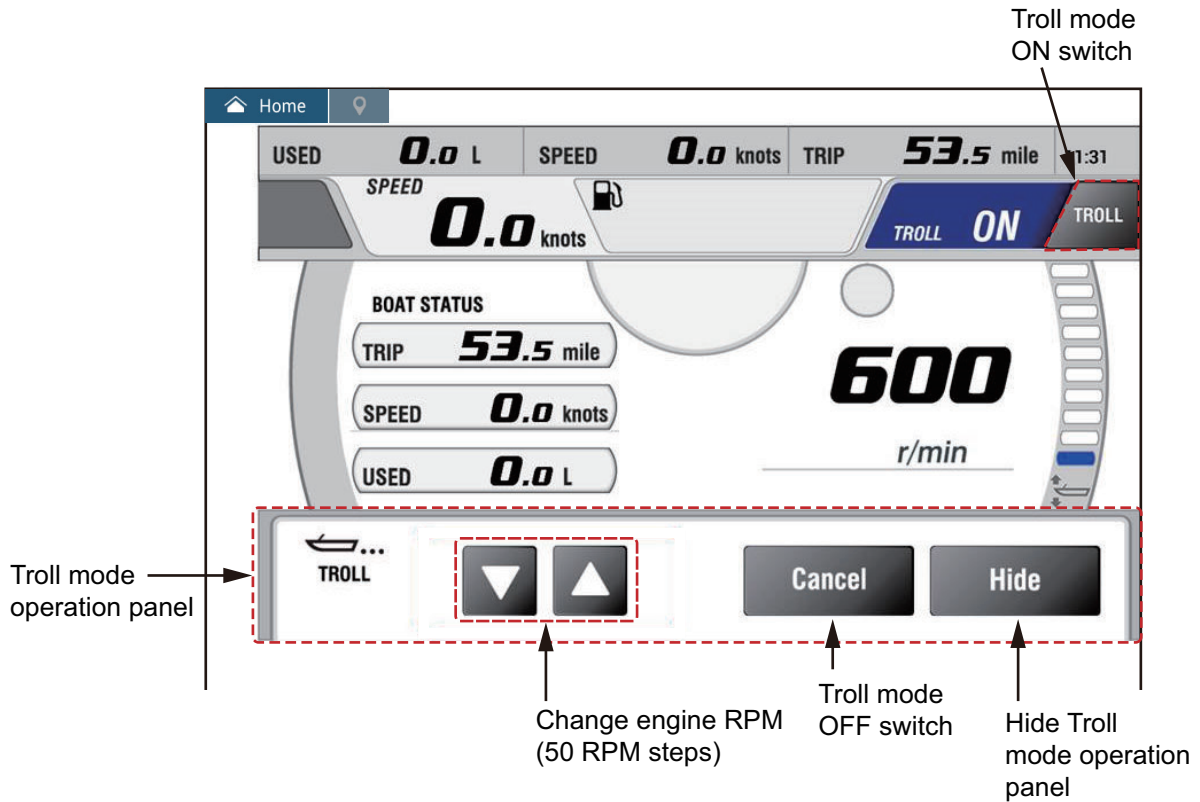

12.7.6 Trouble codes

Trouble codes generated by the engine can be reviewed on the [YAMAHA ENGINE SETUP] menu, in the [Initial Setup] menu. For detailed information, see the Operator's Manual for the Yamaha engine.

PORT ENGINE	
250-168-4	Battery voltages low Check battery and wiring. Shift to Neutral! Open bypass valve to disabled motor. Consult Yamaha dealer.
250-9-14	Engines too close In joystick: Main power OFF 20 sec, turn ON, check steering. In normal mode: Shift to neutral! Open bypass valve to disabled motor. Consult Yamaha dealer.
250-424-0	SCU to PCU communication Shift to Neutral! Open bypass valve to disabled motor. Consult Yamaha dealer.
164-254-14	Program memory Consult Yamaha dealer.
187-240-2	Program memory

12.7.7 Alarm list

When an engine alarm is violated, you can see the name of the offending alarm on the [Alarms] list. See section 2.10.9 for details.

13. WEATHER OPERATIONS

This chapter describes how to operate the built-in weather feature, NavCenter, and the optional Furuno BBWX SiriusXM weather receiver. Your weather receiver provides weather information (U.S.A only), in analog and digital forms. The SiriusXM satellite radio is also available with a SiriusXM satellite radio subscription.

13.1 Weather Display Introduction

Your NavNet TZtouch3 has a built-in NavCenter weather data, via an Ethernet connection, and optional weather data via the FURUNO BBWX SiriusXM weather receiver.

Note: For BBWX SiriusXM weather receiver operations, see section 13.3.

How to select the weather display

The weather display is overlaid on the 2D chart plotter display. Select the weather display on the Home screen, by tapping the weather display icon.

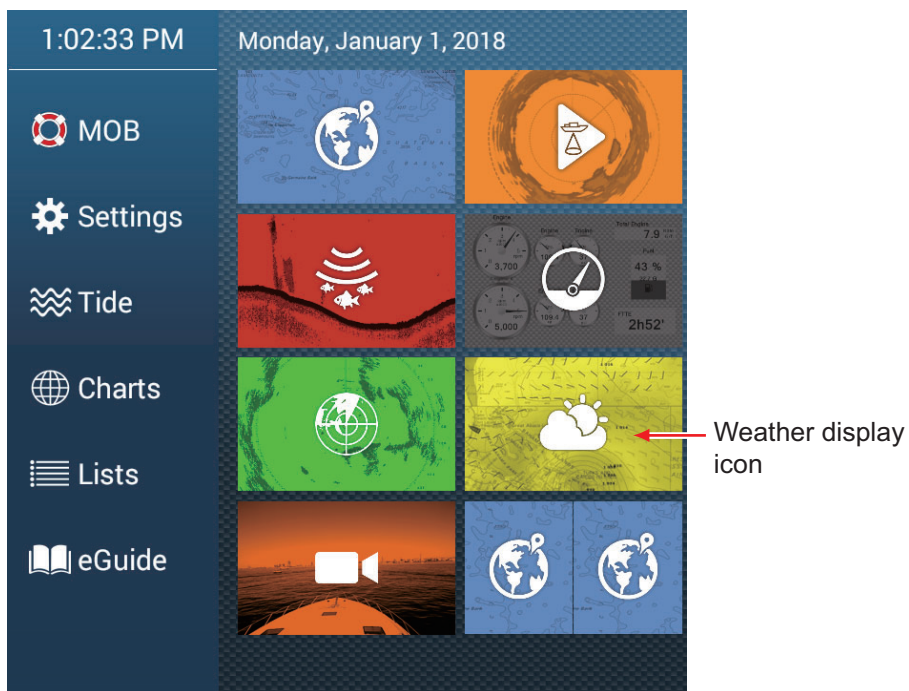

13.2 NavCenter Weather

You can download the NavCenter data from the internet via Wireless LAN. See section 1.19 for how to connect to the internet.

13.2.1 How to set up for NavCenter weather

1. Open the Home screen, then tap [Settings]→[Weather].
2. Tap [Load Weather File].
Note: The option [Sirius] appears when connecting a FURUNO BBWX series weather receiver.
3. Tap [NavCenter] then tap < to return to the menu.
4. Tap [Tidal Step].



5. Tap the update interval (which determines how often tidal data are captured) for the tide icon.

- Tap [Duration of Animation].

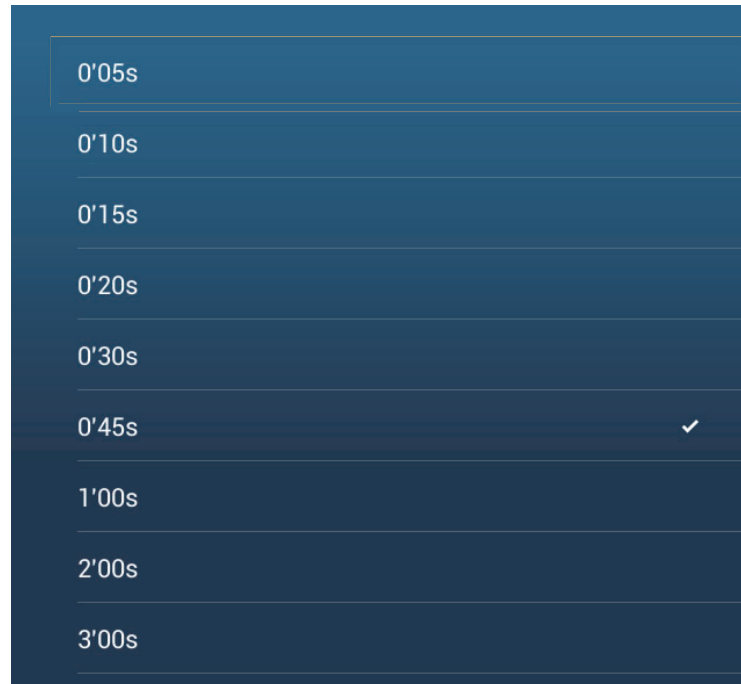

- Tap the update interval for the animation. The larger the time, the slower the animation moves.

13.2.2 How to download the NavCenter weather data

- Open the Home screen, then tap [Settings]→[General].
- Tap [Wireless LAN Settings].
- Turn on [Wireless].
- After the internet connection is established, tap the close button to exit.
- Open the Home screen, then tap [Settings]→[Weather].



13. WEATHER OPERATIONS

6. Tap the data model from [Model] in the [NAVCenter Download] section. (The options are [USA] and [Worldwide].)
7. Drag the slider in [Forecast Days] to select how many days' data to download.
8. Turn on the items to receive, from [Wind] to [Plankton].
9. For [Sea Surface Temperature], set the following menu items.

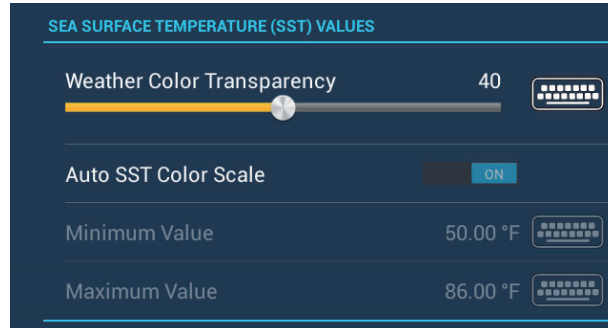

[Weather Color Transparency]: Adjust the degree of transparency for the weather overlay. Use a large figure to increase the degree of transparency.

[Auto SST Color Scale]: Activate this feature to adjust the SST color scale automatically according to the sea surface temperature.

[Minimum Value]: Set the minimum value for the SST color when [Auto SST Color Scale] is deactivated.

[Maximum Value]: Set the maximum value for the SST color when [Auto SST Color Scale] is deactivated.

10. Tap the close button on the title bar to finish.
11. Open the weather display, then tap the screen to show the pop-up menu. Tap [Get Latest Wx].

The notification bar at the top of the screen flashes the message "Weather Update in Progress" during the downloading. If the downloading was successful, the message "DOWNLOAD SUCCEEDED" appears. Tap [OK] to finish.

13.2.3 How to display the NavCenter weather data

The NavCenter data display provides forecast data that includes [Wind], [Waves], [SST] (sea surface temperature), [Cloud], [Rain], [Pressure], [500mb], [Air Temp], [Currents], [Altimetry], [Plankton].

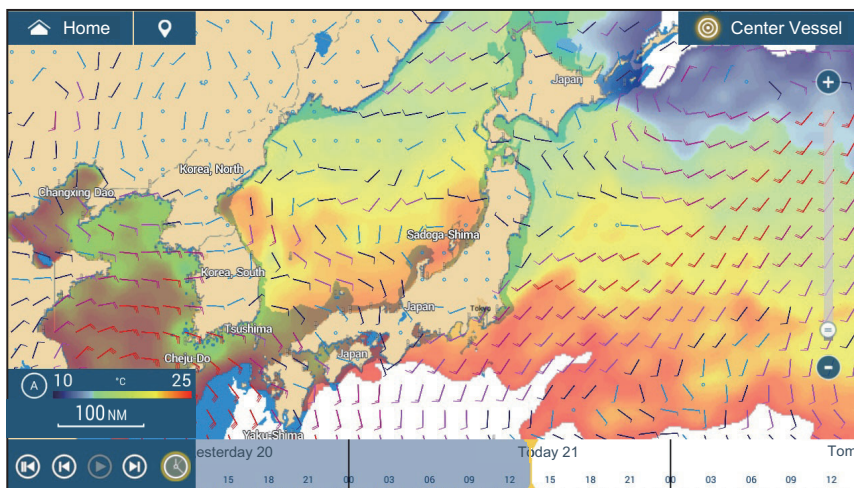

1. Tap the screen to show the pop-up menu, then tap [Wx Data].
2. Turn on necessary data (wind, waves, etc.).
3. The animation display provides a visual presentation of the weather over time. To start the animation display, tap the  icon on the animation bar at the bottom of the screen. The display shows the forecast for the date and time selected. Drag the time scale horizontally to select a time - left for past time, right for future time. To stop the animation display, tap [End Anim] (top left-hand corner of screen).



Tap to return to beginning of animation display.

Tap to fast rewind animation display.

Tap to playback the animation display.

Tap to fast forward the animation display.

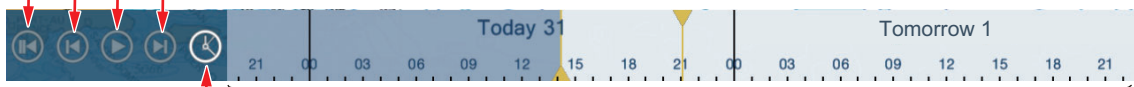

The time scale moves.

Tap to set the time scale to the current time and display the current data.



Tap to temporarily stop the animation display.

How to find weather data for a location

Tap desired location to show the pop-up window. Scroll the window to see other data.

Wind Force	18.2 kn
Wind Dir.	145.3 °
Waves Height	+7.45 ft
Waves Dir.	289.9 °
Waves Period	0'07s
Currents Speed	0.6 kn
Currents Dir.	8.2 °
SST	71.0 °F
Air Temp	67.9 °F
Cloud	60%

13.2.4 How to load a weather file

You can load a weather file saved on a microSD card or USB flash memory.

1. Set the media containing the weather file in the microSD card drive or the USB port.
2. Open the Home screen, then tap [Settings]→[Weather]→[Load Weather File].
3. Tap the data to load then tap [OK].
4. After the equipment has loaded the selected data, tap the close button on the title bar to finish.

13.3 SiriusXM Weather

SiriusXM weather radar information and advanced weather information are available in North America with connection of the FURUNO BBWX SiriusXM weather receiver. SiriusXM satellite radio is also available with a SiriusXM satellite radio subscription.

Your system displays the current and forecasted marine weather information for your area. The weather information is updated in real time so that you have current weather information for your area and any area in the U.S.

Information provided by the FURUNO BBWX SiriusXM weather receiver service is advisory in nature. You, the customer, agree to release FURUNO ELECTRIC CO., LTD., SiriusXM satellite radio INC, Navcast Inc. and WSI Corporation from any problems that occur from this service. And you acknowledge that you have read the conditions of your subscription agreement and agree to all the conditions of the subscription. If you do not have the subscription agreement, go to <https://www.siriusxm.com/marine-weatheragreement>, or call 1-855-796-9847 to have a copy sent to you.

You can put a point on the weather display. Tap the screen where to put a point, then tap [New Point] on the pop-up menu.

Before using your SiriusXM satellite weather receiver...

- Purchase a SiriusXM satellite weather service subscription. Contact SiriusXM satellite radio INC. for additional information.
- Purchase a SiriusXM satellite radio service subscription. Contact SiriusXM satellite radio INC. for additional information.
- After installation of the FURUNO BBWX SiriusXM weather receiver, make sure to check the NavNet TZtouch3 sensor list to make sure the BBWX appears in the sensor list.

The screenshot shows a 'Sensor List' window with a 'Reset' button and a close icon. Below the title bar is a section labeled 'NETWORK SENSOR' containing a table with the following data:

Name	NickName	Version	IP	HostName
TZTL12F	TZTL12F	02.04:02.04:01.26 V3:	172.031.252.003	MF252003
BBWX4	BBWX4		172.31.200.20	
TZT14	TZT14	04.03:25.01:01.01	172.031.252.001	MF252001
TZTL15F	TZTL15F	02.04:02.04:01.25 V3:	172.031.252.002	MF252002

If the receiver does not appear in the list, check the Antenna LED on the FURUNO BBWX SiriusXM weather receiver and the connection between the two units. The LED is solid violet when a normal antenna connection is detected, and off or flashing violet in case of antenna short circuit.

- Connect the FURUNO BBWX SiriusXM weather receiver and the NavNet TZtouch3 displays then turn on both of those units. Your unit then receives WX data from the weather receiver, which takes approximately 30 minutes.

13.3.1 How to set up for SiriusXM weather

1. Open the Home screen, then tap [Settings]→[Weather]→[Weather Data Server].
2. Tap [Sirius] then tap < to return to the menu.
3. Tap [Sirius Weather Radar].
4. Tap the SiriusXM weather radar to use, [US Now Radar] (USA) or [CanadRad] (Canada). [US Now Radar] shows the type and level of precipitation. The amount of precipitation increases with level.

Precipitation indication on USNowRadar.

Weather radar color	Precipitation type	Level
Light green	Rain	15-19 dBz
Medium green	Rain	20-29 dBz
Dark green	Rain	30-39 dBz
Yellow	Rain	40-44 dBz
Orange	Rain	45-49 dBz
Light red	Rain	50-54 dBz
Dark red	Rain	over 55 dBz
Light blue	Snow	5-19 dBz
Dark blue	Snow	over 20 dBz
Light pink	Mixed	5-19 dBz
Dark pink	Mixed	over 20 dBz

Precipitation indication on CanadianRadar

Weather radar color	Level (mm per hour)
Transparent (low precipitation)	0.00 to 0.20 mm/hr
Light green	0.21 to 1.00 mm/hr
Medium green	1.01 to 4.00 mm/hr
Dark green	4.01 to 12.00 mm/hr
Yellow	12.01 to 24.00 mm/hr
Orange	24.01 to 50.00 mm/hr
Light red	50.01 to 100 mm/hr
Dark red	over 100.01 mm/hr

5. Tap the close button on the title bar to finish.

13.3.2 How to display the SiriusXM weather data

[Wx Radar] (Weather radar)

NOWRAD and Canadian weather radar information are put on top of your chart (see subsection 13.3.1). To display the weather radar, turn on [Wx Radar] from the layer menu.

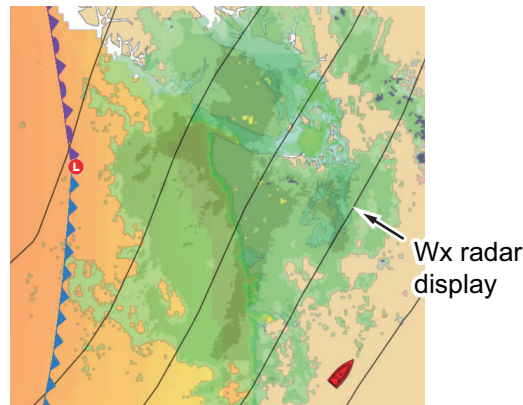

[Adv Wx Data] (Advanced weather)

The advanced weather display provides the weather data; [Buoys], [City], [Storm], [Lighting] or [Storm Tracks] or [Marine Zone]. For the icons of these data, see section 13.4.

1. Tap the screen to show the pop-up menu, then tap [Adv Wx Data].
2. Tap a menu item to display its data.
3. Repeat steps 1 and 2 to select all menu items desired.

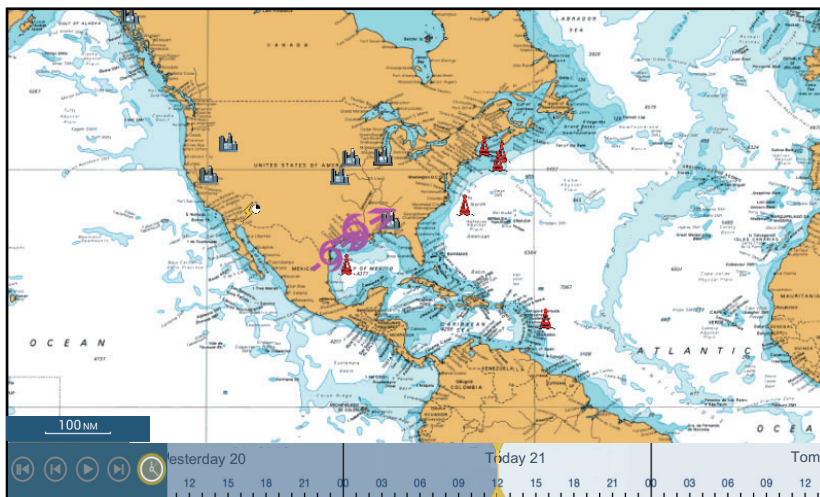







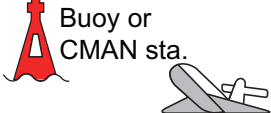

[Anim Radar] (Animation radar)

The animation radar display provides the past weather radar information. To show the animation radar display, tap [Anim Radar] on the pop-up menu. To stop the animation display, tap [End Anim] at the top right-hand corner of the screen.

13.4 Weather Icons (SiriusXM Weather)

The table below shows the weather icons that appear on the SiriusXM weather display. You can show or hide these icons from the pop-up menu, with [Wx Data].

Icon	Meaning
	Storm cast
	Lightning
 Buoy or CMAN sta.	Surface observation stations
	Wind
	City
	Currents
	Storm tracks
 etc.	Surface pressure

13.5 Weather Data (NavCenter or SiriusXM Weather)

The table below shows the weather data available for displaying according to weather data server (NavCenter or SiriusXM weather).

Items	NavCenter	SiriusXM	Item	NavCenter	SiriusXM
Wind	Yes	Yes	Currents	Yes	No
Waves	Yes	Yes	Altimetry	Yes	No
SST	Yes	Yes	Plankton	Yes	No
Cloud	Yes	No	Buoys	No	Yes
Rain	Yes	No	City	No	Yes
Pressure	Yes	Yes	Storm	No	Yes
500mb	Yes	No	Lightning	No	Yes
Air Temp	Yes	No	Storm Tracks	No	Yes

[Wind]: The wind forecast displays the wind speed by color. The bar at the bottom points in the wind direction.

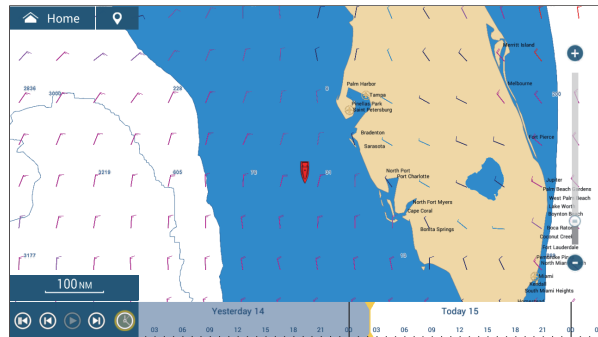
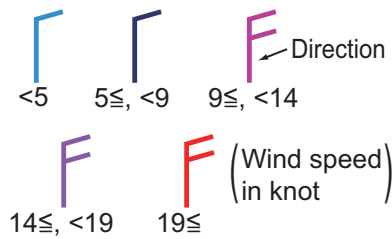

[Waves]: The waves forecast displays wave height with color. 0 foot (minimum) is displayed in light blue, 35 feet (maximum) in red.

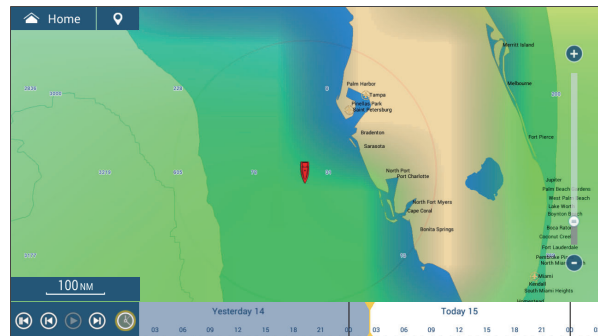

[Cloud]: The cloud forecast displays cloud images. 8% of cloud amount (minimum) is displayed in white, 100% (maximum) in black. The cloud amount under 8% is transparent.

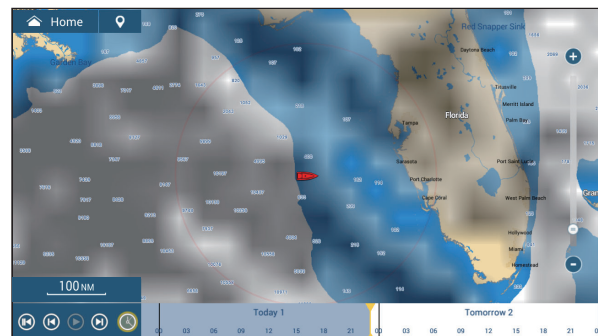

[Rain/Snow]: The rain/snow forecast displays rain/snow images. 0.1 mm/hour of rainfall/snowfall (minimum) is displayed in green, 5 mm/hour (maximum) in dark violet.

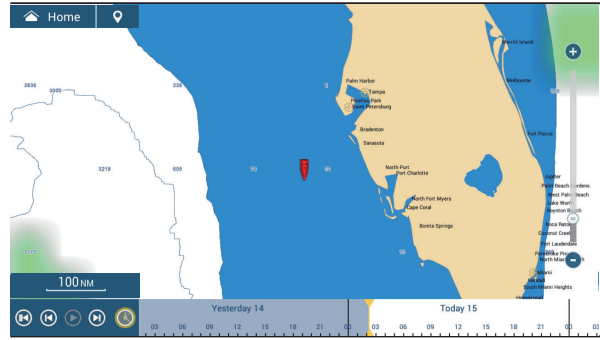

[Air Temp]: The air temp forecast displays the air temperature by color. -45°C (-49°F) (minimum) is displayed in dark violet, 45°C (113°F) (maximum) is displayed in red.

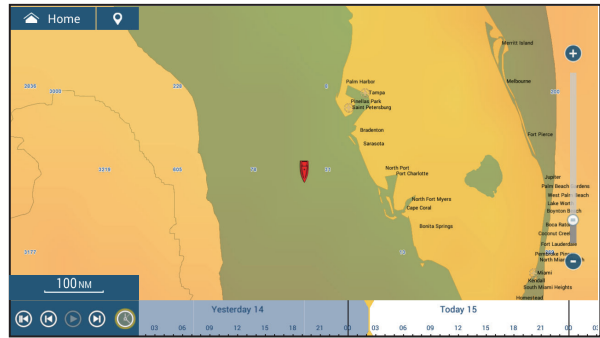

[Pressure]: The pressure forecast displays surface pressure.

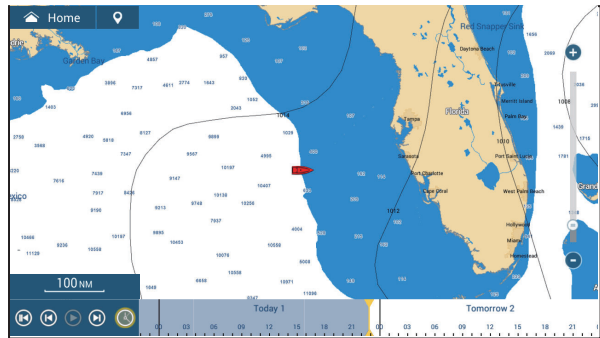

[500mb]: The 500mb forecast displays the contour lines over 500 mb.

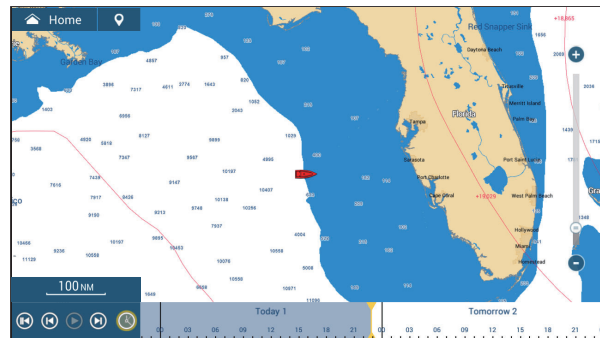

13. WEATHER OPERATIONS

[SST] (Sea surface temperature): This data layer shows the temperature of the sea surface in shades. Lower temperatures are in dark blue, higher in red.

On the screen, you can turn on or off the automatic SST scale by tapping [A]. Set the minimum or maximum value for which to show SST. See page 3-5 for how to set the value. This is available when [Auto] is off.

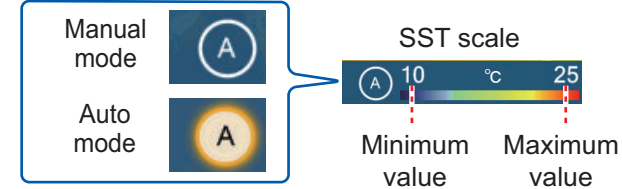
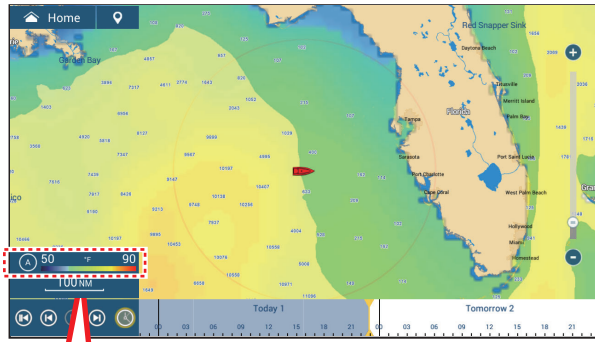

Tap “A” to select automatic or manual adjustment for the SST scale.

Manual mode: Use the slider bar to set scale.

Auto mode: SST scale automatically set according to the depth shading selection set in the menu ([Settings]→[Plotter]).

[Currents]: The current forecast displays the tidal current speed and direction by blue arrow. The darker the blue, the faster the current speed (0 to 2 kn).

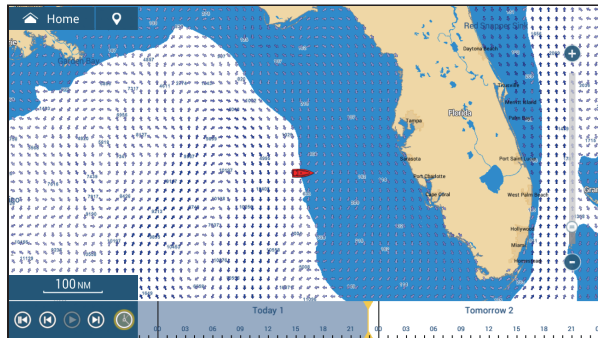

[Altimetry]: The altimetry forecast displays the sea height anomalies by color. The large anomalies are displayed in red, smaller ones in light green.

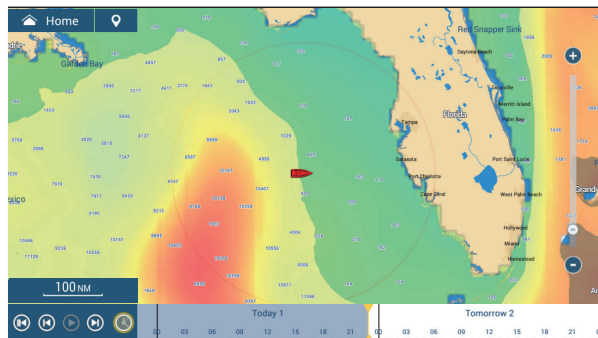

[Plankton]: The plankton forecast displays the plankton growth in tones of green. The darker the green, the greater the density of the plankton.

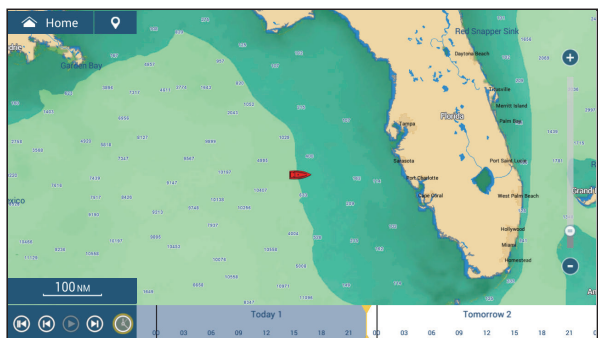

13.6 SiriusXM Weather Diagnostics

Your FURUNO BBWX SiriusXM weather receiver can be checked for proper operation as shown below.

1. From the Home screen, tap [Settings]→[Initial Setup] to show the [Initial Setup] menu.
2. Scroll down to the [SIRIUS DIAGNOSTIC] window, then tap [Sirius Weather Diagnostic]. The count for each weather item is shown.

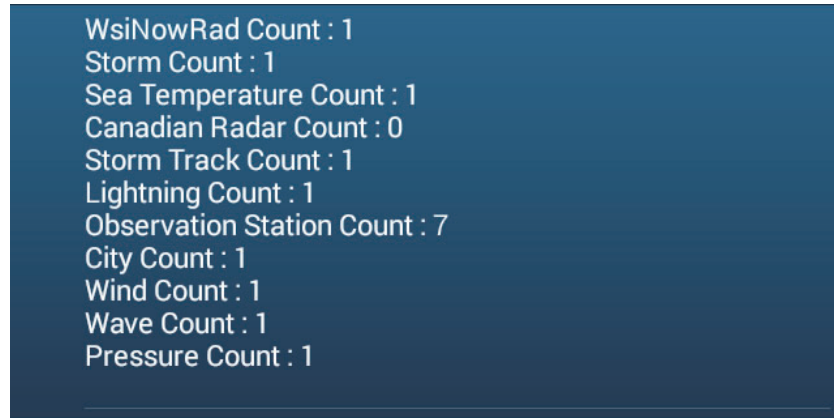

13.7 SiriusXM Satellite Radio

The SiriusXM satellite radio provides round-the-clock, 100% commercial-free music from every genre plus sports, news, talk and comedy.

13.7.1 How to enable the radio

Method 1: From the Home screen

Go to the Home screen and tap the [Sirius] icon to show the full screen SiriusXM radio controls. See the next page.



Method 2: From the Slide-out menu

Open the Slide-out menu, then tap the [Sirius Audio] icon to show or hide the audio control bar. See the next page for how to operate the audio control bar.

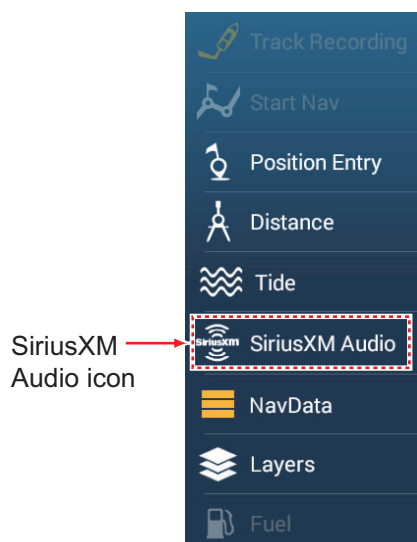

13.7.2 How to operate the radio controls

Full screen controls

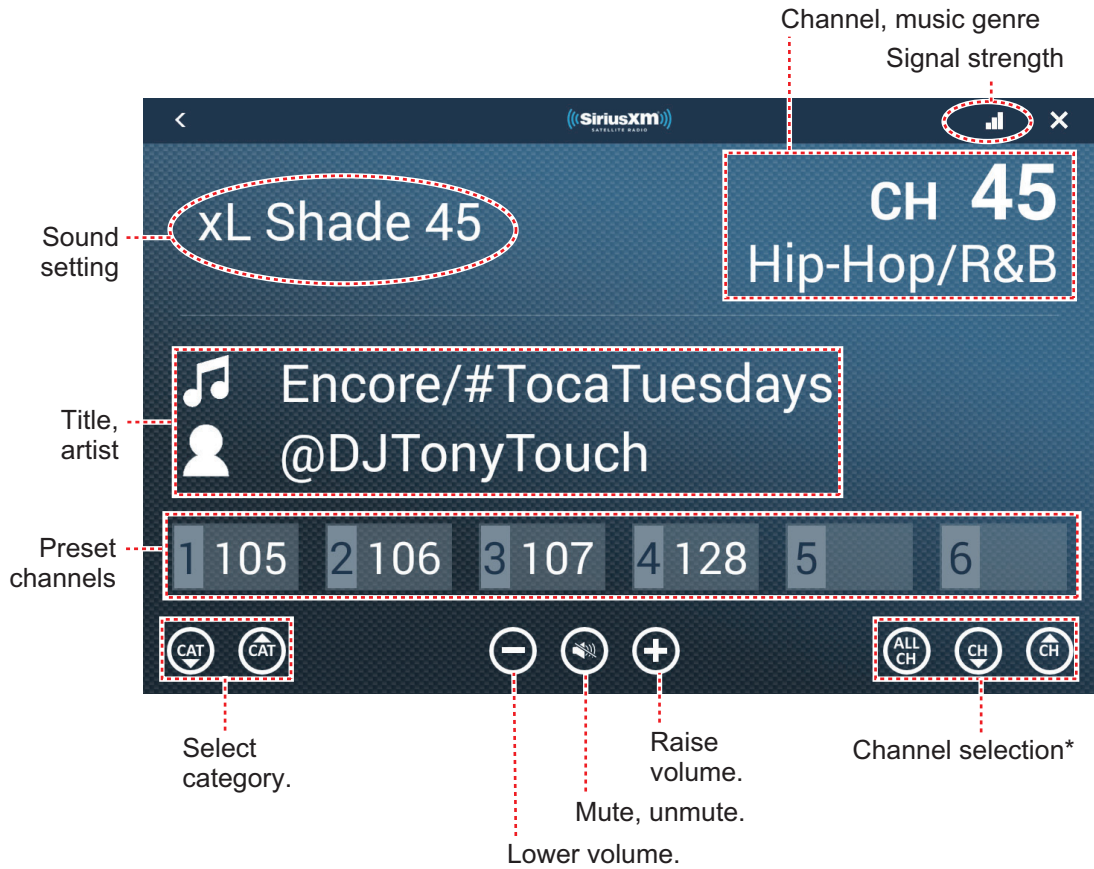

*: The channel ▲ and ▼ down buttons cycle through the available channels within the selected category. To allow the system to cycle through all categories and channels, tap the ALL CH button. Tap the button again to return to category-based channel selection.

Audio control bar controls

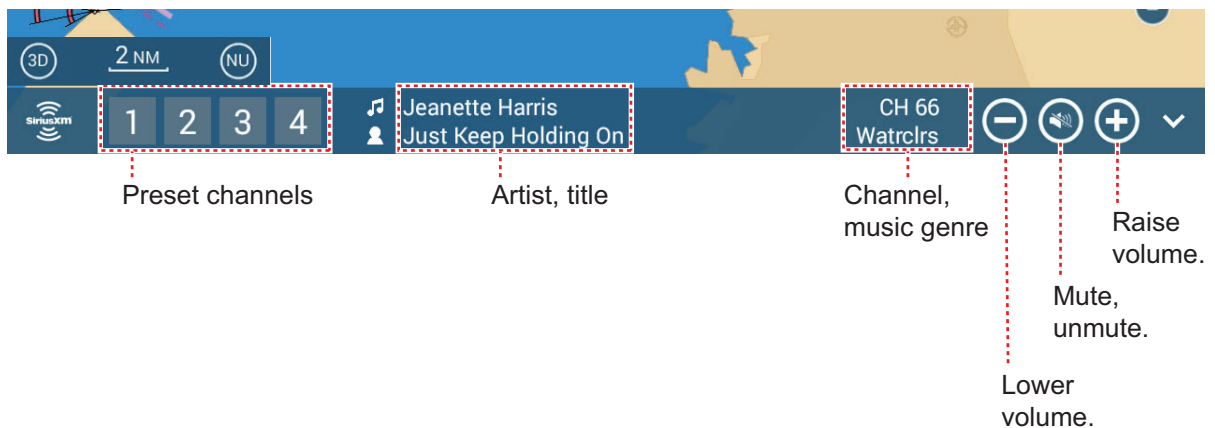

13.7.3 Radio diagnostics

Your SiriusXM satellite radio can be checked for proper operation as shown below. This test is intended for the service technician.

1. From the Home screen, tap [Settings]→[Initial Setup] to show the [Initial Setup] menu.
2. Scroll down to the [SIRIUS DIAGNOSTIC] window, then tap [Sirius Radio Diagnostic]. The count for each weather item is shown.

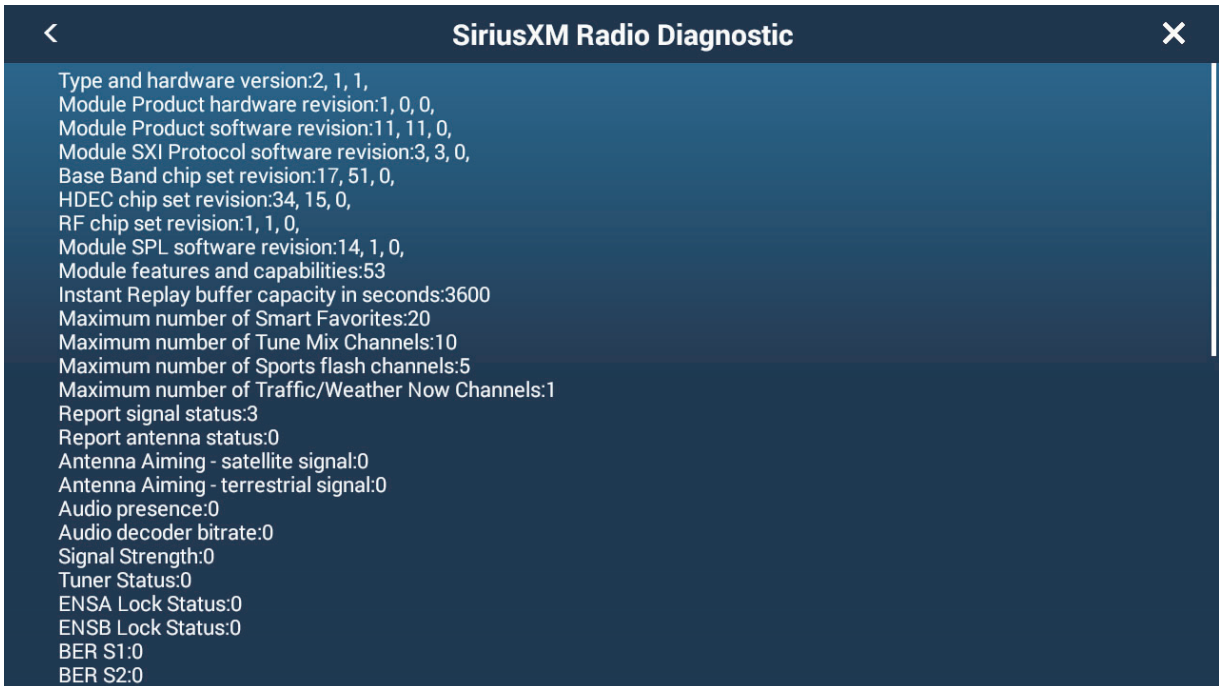

13.8 Fish Mapping

This section provides an overview to the Sirius Fish Mapping features. For detailed information, see the Owner's Manual for Fish Mapping.

The Fish Mapping service provides you with real time fishing information to help get you to the spots where fish are most likely to be located. This service shows forecasted fishing hotspots directly on your display, using the following data.

- Fish recommendations
- Weed lines
- Sea surface height anomaly
- Sea surface temperature contours
- Sea surface temperature front strength
- 30m subsurface sea temperatures
- Plankton concentration contours
- Plankton front strength

13.8.1 How to show the fish mapping display

On the Home screen, tap the Fish Mapping icon to show the Fish Mapping display.

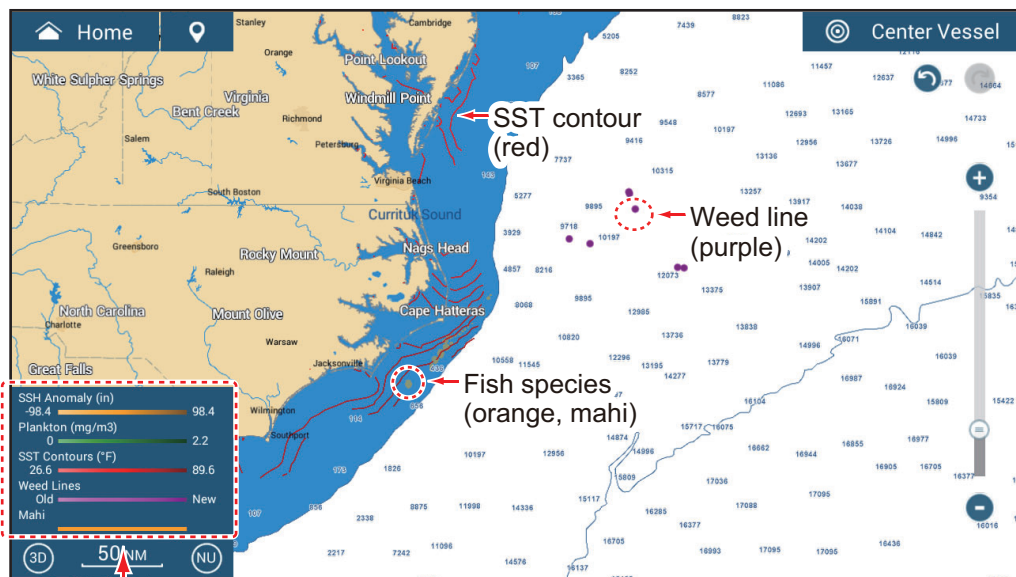
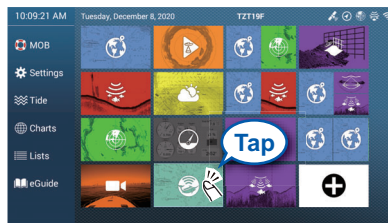

Legend

13.8.2 Fish mapping features

How to show, hide the fish mapping features

You can show or hide the Fish Mapping features from the Layers menu. Tap the applicable flipswitch to show or hide a feature.

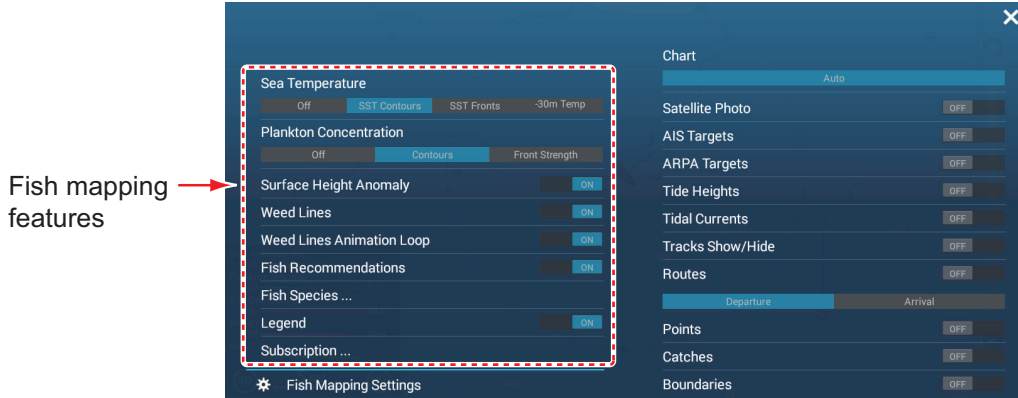

Fish mapping features description

Sea temperature

[SST Contours]: Show the water temperatures in your selected area. Use these contours to help locate your target species based on their preferred temperature range. The contours are colored in shades of red and the temperature values are shown in orange. Updated every three hours.



[SST Fronts]: Show estimated strength of ocean fronts. These “fronts” concentrate nutrients which attract bait fish and also create barriers to fish movement. The fronts are colored in shades of red and the front strengths are shown in orange. Front strength is indicated with a numeral from 1-4, 4 being the highest strength. Updated every 24 hours.

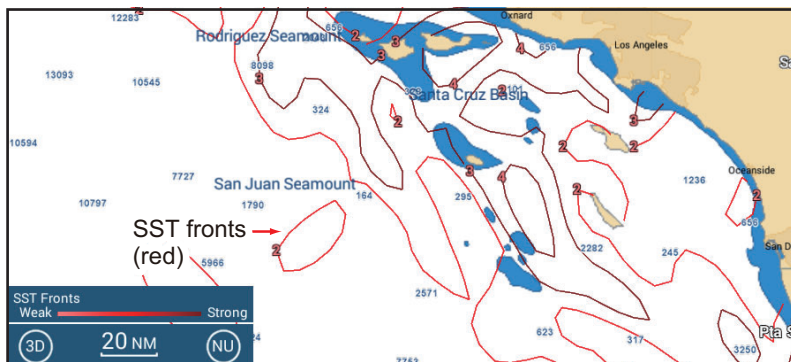

[-30m Temp]: Show the water temperature 30 meters below the surface. This feature allows you to identify areas with the preferred temperature range of your target game fish. The contours are colored in shades of red and the temperature values are shown in orange. Updated every 24 hours.

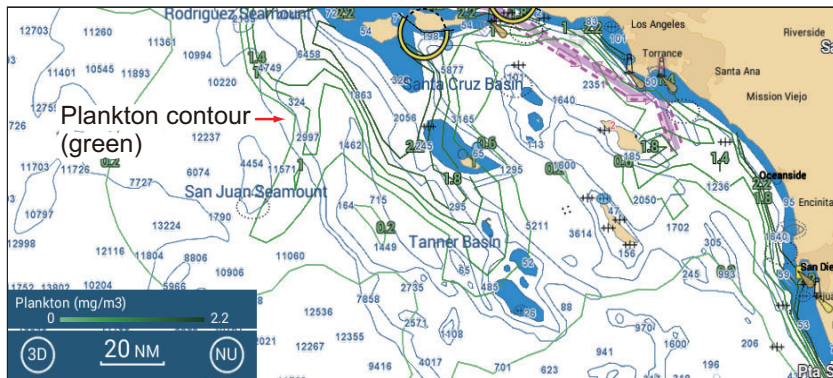

Plankton concentration

[Contours]: Show area of plankton concentrations. Plankton is the primary food source for most bait fish, which attract hungry game fish. You can find locations of plankton to identify favorable conditions for your target fish. Contours are shown in shades of green, and updated every 24 hours.

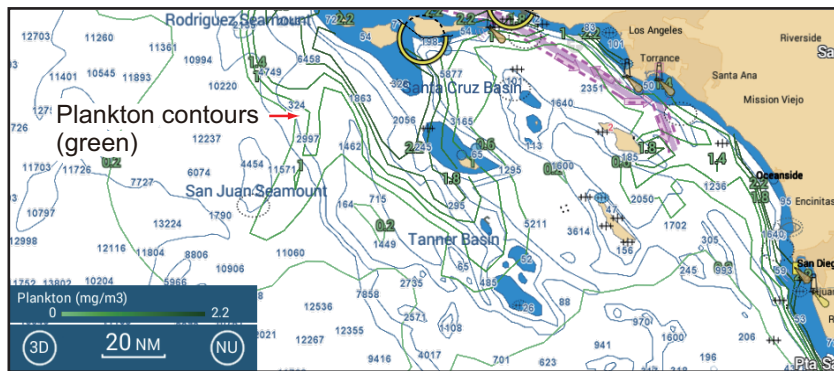

[Front Strength]: View areas with strong plankton concentration bordering areas with relatively little or no plankton. Strong plankton fronts indicate where nutrient-rich water favorable for bait fish occurs next to clear, predator-preferred water. The fronts are colored in shades of green and the front strengths are shown in green. Front strength is indicated with a numeral from 1-4, 4 being the highest strength. Updated every 24 hours.

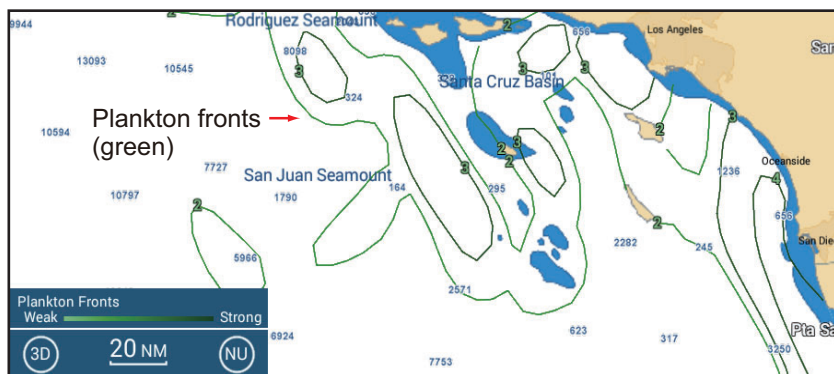

13. WEATHER OPERATIONS

Sea surface height anomaly

View locations where the sea surface height is noticeably different than the surrounding area. Helps you locate “upwellings” - areas of nutrient-rich water that attracts bait fish and game fish. Contours are shown in shades of orange, and updated every 24 hours.

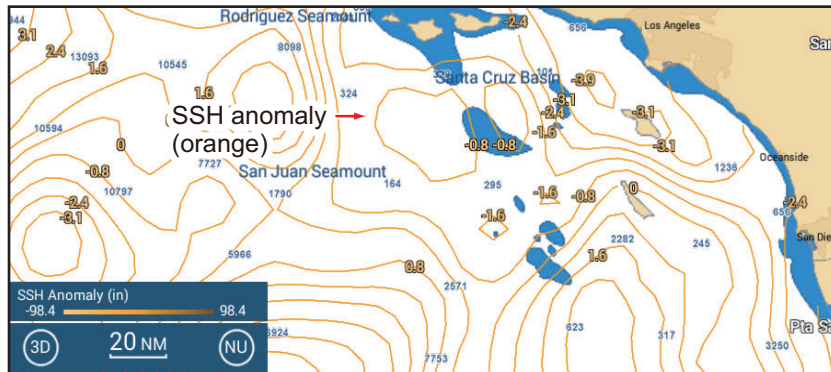

Weed lines, weed lines animation loop

Show concentrations of floating algae/plants. Floating algae/plants provide nutrients and cover for bait fish and shrimp and attract larger, predatory game fish. Weed lines are shown in shades of purple, and updated every 24 hours. The **weed lines animation loop** shows weed lines drift and shift over three days time

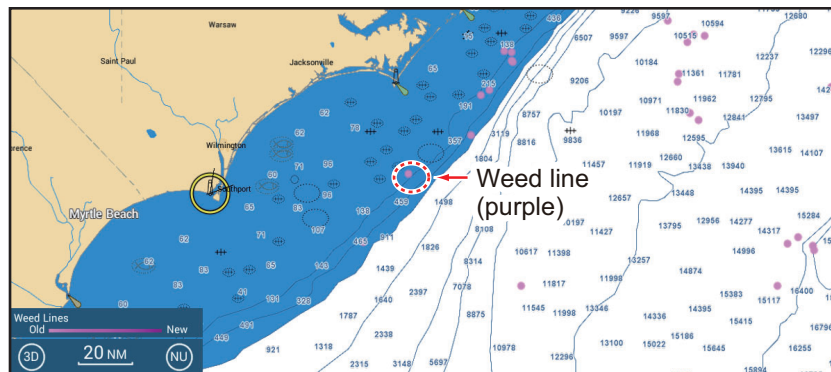

Fish recommendations

Show locations for finding specific types of game fish, based on data-driven analysis. The locations are overlaid on your chart and can be viewed in combination with other features. Each fish species is shown in a distinct color. Updated twice per week.

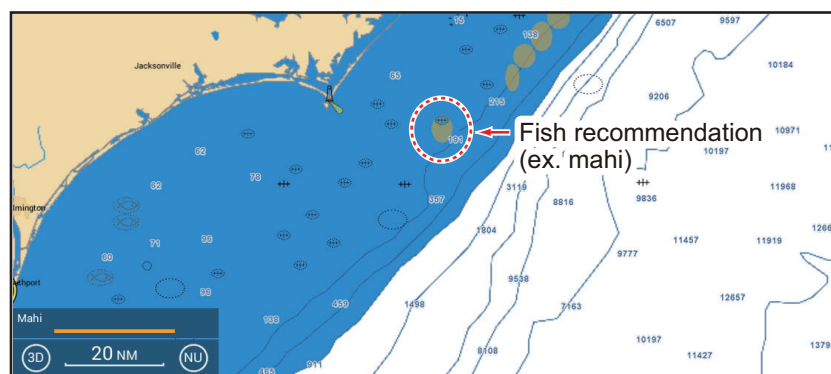

Fish species

Show or hide fish recommendations. Tap to show the [Fish Species Selection Window]. Turn fish species on or off as required.



Legend

The legend is shown at the bottom left corner of the display, and provides a key to all the Fish Mapping features currently shown. You can show or hide the legend with [Legend].

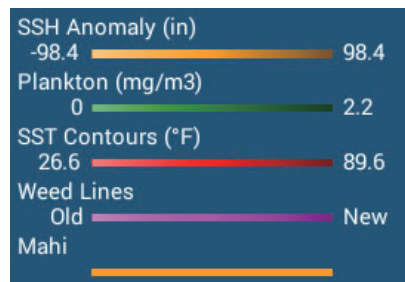

Subscriptions

Show the date and time the Fish Mapping features were updated and received.

Marine Fish Mapping		
	Updated	Received
Fishing Recommendations	5/19/2020 12:57 PM	00:16
Plankton Concentration Contours	5/20/2020 12:57 PM	00:17
Plankton Front Strength	5/20/2020 12:57 PM	00:17
30m Sub-Surface Temp. Contours	5/20/2020 12:57 PM	00:17
Sea Surface Height Anomaly	5/20/2020 12:57 PM	00:17
Sea Surface Temperature Contours	5/21/2020 12:57 PM	00:17
Sea Surface Front Strength	5/20/2020 12:57 PM	00:17
Weed Lines	5/20/2020 12:57 PM	00:16

13.8.3 How to show fish mapping data

Tap a Fish Mapping feature to show its data in the pop-up display. Below are sample Fish Mapping data.

Lat N 35°46.135' Lon W 75°12.995' SST Contour 64 °F 5/21/2020 12:57 PM New Point Goto New Route New Boundary >	Lat N 39°34.294' Lon W 124°47.748' SST Front Moderate 5/20/2020 12:57 PM New Point Goto New Route New Boundary >	Lat N 39°46.008' Lon W 125°34.397' -30m Temp. Co... 53.6 °F 5/20/2020 12:57 PM New Point Goto New Route New Boundary >	Lat N 39°32.235' Lon W 125°30.228' SSH Anomaly 2.4 in 5/20/2020 12:57 PM New Point Goto New Route New Boundary >
<i>SST Contour</i>	<i>SST Front</i>	<i>-30m Temp. Contour</i>	<i>SST Anomaly</i>
Lat N 39°48.769' Lon W 124°35.156' Plankton C... 0.2 mg/m3 5/20/2020 12:57 PM New Point Goto New Route New Boundary >	Lat N 39°49.675' Lon W 124°39.300' Plankton Fr... Moderate 5/20/2020 12:57 PM New Point Goto New Route New Boundary >	Lat N 34°32.512' Lon W 75°43.821' Weed Lines 5/18/2020 12:57 PM New Point Goto New Route New Boundary >	Lat N 34°51.798' Lon W 75°33.561' Mahi Area 5/19/2020 12:57 PM New Point Goto New Route New Boundary >
<i>Plankton Contour</i>	<i>Plankton Front</i>	<i>Weed Lines</i>	<i>Fish Recommendation</i>

13.8.4 How to change fish mapping settings

You can change the range for each Fish Mapping feature. Open the Layers menu, then tap [Fish Mapping Settings]. The Fish Mapping settings can also be accessed from the [Fish Finder] menu.

SST Contours Min	26.60 °F	
SST Contours Max	89.60 °F	
-30m Temp. Contours Min	26.60 °F	
-30m Temp. Contours Max	89.60 °F	
SSH Anomaly Contours Min	-98 in	
SSH Anomaly Contours Max	98 in	
Reset Default Settings		

14. AIS, DSC MESSAGE

14.1 What is AIS?

AIS (Automatic Identification System) is a system that continuously transmits the identification and position of your ship to AIS-equipped ships within VHF range. All such ships also receive data from other AIS-equipped ships and display their positions and other relevant information. The AIS broadcasts this information over a VHF transceiver. The information is as shown below.



- Position
- Name of ship
- Course over ground
- Heading
- Call sign
- Speed over ground
- Rate of turn

14.2 How to Show or Hide the AIS Symbols

1. On the radar display or chart plotter display, open the Layers menu.
2. Turn [AIS Targets] on or off.





14.3 AIS Target Symbols

Target type	Symbol	Description
Activated AIS target	<p><u>Symbol color</u> Blue: Class A AIS target Green: Class B AIS target Blue (hollow): BFT AIS target (see next page)</p>	COG is indicated on the symbol with a dashed line. Note: An AIS symbol that has a "TX marker" (callout) above it indicates that vessel has transmitted an AIS message. TX marker (callout)
Dangerous AIS target	Color: Red 	The target whose CPA and TCPA are smaller than the CPA/TCPA (see section 14.11). alarm setting is indicated as a dangerous target.

Target type	Symbol	Description
Lost AIS target	 <p><u>Symbol color</u> Blue: Class A AIS target Green: Class B AIS target Blue (hollow): BFT AIS target (see next page)</p> <p><u>Cross mark color</u> Red</p>	An AIS target becomes a lost target if a signal is not received from the AIS target for x* minutes. The lost target symbol is erased if a signal is not received for an additional x* minutes. *: The time depends on the AIS transponder. Check the operator's manual for your AIS transponder for information about lost targets.
No CPA/TCPA target	 <p>Class A AIS (Symbol color: Blue)</p> <p>Class B AIS (Symbol color: Green)</p>	AIS symbols are shown in broken lines in the following cases: <ul style="list-style-type: none"> • No water or ground tracking speed of your ship, or there is no speed data. All AIS symbols are shown in broken lines. • No speed data from AIS target. The symbol of the corresponding AIS target is shown in broken lines. A target with neither a reported heading nor COG is oriented toward the top of the operational display area.

Note: This unit is equipped with the Blue Force Tracking (BFT) function.

Other AIS symbols that may appear are shown in the table below.

Symbol	Meaning
	AtoN
	Base Station
	Aircraft
	SART

14.4 Proximity AIS Target Alarm

The proximity AIS target alarm alerts you when an AIS target is within the distance you specify, and is applicable to both displayed and not displayed targets. When an AIS target is within the distance set, the alarm indication "Proximity AIS Alarm" flashes in the status bar and the audio alarm sounds. (See subsection 2.10.9).

1. Open the Home screen, then tap [Settings]→[Targets].
2. Turn on [Proximity AIS Target Alarm].
3. Tap [Proximity AIS Target Alarm Value] to open the software keyboard.
4. Set the alarm value, then tap [✓].
5. Tap the close button on the title bar to finish.

14.5 How to Ignore Slow Moving AIS Targets

The proximity AIS target alarm may often sound in areas of heavy vessel traffic. You can prevent frequent release of the alarm against slow, non-threatening targets by specifying the maximum target speed that triggers the alarm. Any target whose speed is lower than set here does not trigger the alarm.

1. Open the Home screen, then tap [Settings]→[Targets].
2. Tap [Ignore Alarms for AIS Slower than...] to open the software keyboard.
3. Set a speed, then tap [✓]. Any AIS target whose speed is lower than set here is ignored.
4. Tap the close button on the title bar to finish.

14.6 How to Display AIS Safety Messages

When you receive an AIS safety message (addressed or broadcast) from an AIS transponder equipped vessel, the Status bar displays the flashing message "New Text Telegram(s)". Tap the Status bar to display the message. The AIS symbol for the vessel that transmitted the message is put at the center of the screen and a pop-up window appears, showing the AIS safety related message. You can delete the message by tapping [Delete Message].

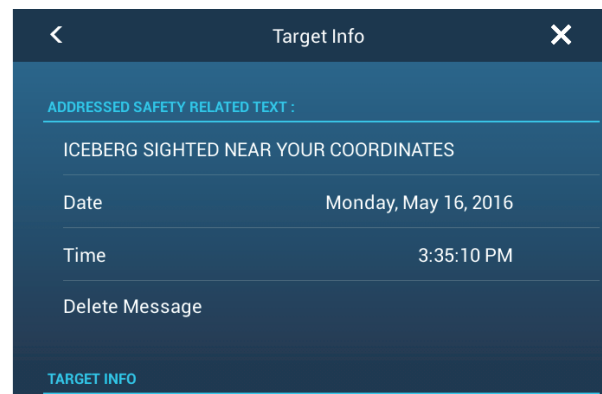

You can disable the AIS message notifications by turning off [AIS Message Notification] in the [Targets] menu.

14.7 How to Display AIS Target Data

Tap an AIS target (chart plotter or radar display) to display the simple information in the pop-up menu.

For detailed information, tap the target, then tap [Info] on the pop-up menu to show the [Target Info] window.

Name	WALLA WALLA...
MMSI	366710810
COG	263.4 °
SOG	0.1 kn
Range	3,289 NM
Bearing	118.0 °
CPA	2,085 NM
TCPA	-1d10h
Last Update	0'07s
New Point	
CPA	<input type="checkbox"/> OFF
Info	

Simple information

Target Info	
TARGET INFO	
Nickname	<input type="text"/>
Name	WALLA WALLA
MMSI	366710810
Call Sign	WYX2158
COG	263.4 °
SOG	0.1 kn
CPA	2,085 NM
TCPA	-1d10h
Range	3,289 NM
Bearing	118.0 °
Destination	WSF TERMINAL
Vessel Type	Passenger ships - All

Detailed information

14.8 How to Show or Hide the Target IDs

You can show or hide the target ID of AIS targets.

1. Open the Home screen, then tap [Settings]→[Targets].
2. Turn [Display Target IDs] on or off.
3. Tap the close button on the title bar to finish.

14.9 AIS List

The [AIS] list provides information about the AIS targets you are receiving navigation data from.

How to open the AIS list

Open the Home screen, then tap [Lists]→[AIS].

The vertical bar before the target name is colored according to that vessel's AIS transponder type or vessel's status.

Blue: Class A AIS transponder

Green: Class B AIS transponder

Red: Dangerous AIS target

Black: Data is not reliable

You can sort the list with the buttons on the title bar.

[Name]: AIS targets sorted in alphanumeric order

[Range]: AIS targets sorted by range in ascending order.

[CPA]: AIS targets sorted by CPA in ascending order.

Note 1: To update the list, tap [Refresh].

Note 2: AIS SART targets appear at the top of the list.



How to display the detailed information for an AIS target

Tap the AIS target on the [AIS] list then tap [Detail]. The name of the AIS is shown in the title bar and navigation data appears in the [TARGET INFO] section.

ACTIONS	
Find On Chart	
TARGET INFO	
Nickname	<input type="text" value="ALKI"/>
Name	ALKI
MMSI	367005420
Call Sign	WDC3297
COG	212.4 °
SOG	0.0 kn
CPA	2,093 NM
TCPA	-1d11h
Range	3,304 NM

How to find an AIS target on the chart plotter display

Tap the AIS target on the [AIS] list, then tap [Find On Chart]. The target is placed at the center of the chart plotter display.

How to edit an AIS nickname

1. On the [AIS] list, tap the AIS target to edit its nickname.
2. Tap [Edit Nickname] to display the software keyboard.
3. Enter the nickname, then [✓] to finish. You can use a maximum of 20 alphanumeric characters.
4. Tap the close button on the title bar to finish.

14.10 AIS SART

When an AIS SART is received (including re-received ones), the message "AIS SART Alarm" appears flashing in the Status bar. Tap the Status bar to acknowledge the message. Then, the AIS SART is put at the center of the screen and the pop-up shown above appears. To set the AIS SART as destination, tap [Goto] on the pop-up.

ACTIONS	
Goto	
TARGET INFO	
NickName	<input type="text" value=""/>

14.11 CPA/TCPA Alarm

This alarm helps you keep your ship away from collision by warning of targets on a collision course. The ARPA continuously monitors the predicted range at the Closest Point of Approach (CPA) and predicted time to CPA (TCPA) of each tracked target. When both the predicted CPA and TCPA are less than their CPA/TCPA alarm values, the target symbol of the vessel on a possible collision course turns red, the audio alarm sounds and the message "CPA/TCPA Alarm" appears flashing in the Status bar.

Make sure that the gain, sea and rain controls are correctly adjusted before you use this alarm. CPA/TCPA alarm ranges must be set correctly according to the size, tonnage, speed, turning performance and other characteristics of your ship.

How to set the CPA/TCPA alarm

1. Open the Home screen, then tap [Settings]→[Targets].
2. Turn on [CPA/TCPA Alarm].
3. Tap [CPA Alarm Value] to display the software keyboard. Set the value (distance) then tap [✓] to finish.
4. Set [TCPA Alarm Value] similarly.
5. Tap the close button on the title bar to finish.

How to acknowledge the CPA/TCPA alarm

The CPA/TCPA alarm generates audio and visual alerts when the CPA and TCPA of an ARPA target are within the CPA/TCPA alarm range. The message "CPA/TCPA Alarm" appears flashing in the Status bar. To acknowledge the alarm and stop the audio alarm and the flashing message, tap "CPA/TCPA Alarm" on the Status bar.

How to deactivate the CPA/TCPA alarm

1. Open the Home screen, then tap [Settings]→[Targets].
2. Turn off [CPA/TCPA Alarm].
3. Tap the close button on the title bar to finish.

14.12 How to Register an AIS or DSC Target to the Buddies List

The buddies list provides a quick reference to ships' MMSI and nickname. For example, you might want to enter the MMSI and nickname of partner ships or ships that often operate in your area.

How to add a buddy to the buddies list

1. Open the Home screen, then tap [Settings]→[Targets]→[Buddies List (AIS & DSC)]. The indication shown below appears.



2. Tap [Add Buddy] to open the numeric software keyboard.
3. Enter the MMSI number of your buddy, then tap [✓].
4. Tap the MMSI number just entered to show the software keyboard.
5. Enter the nickname of your buddy, then tap [✓].

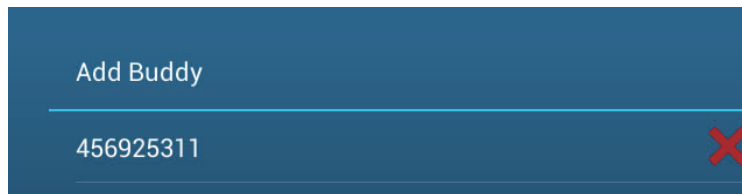

6. Tap the close button on the title bar to finish.

How to delete an entry from the buddies list

1. Open the Home screen, then tap [Settings]→[Targets].
2. Tap [Buddies List (AIS & DSC)].
3. Tap the red "X" (to the right of the nickname) of the buddy to delete.

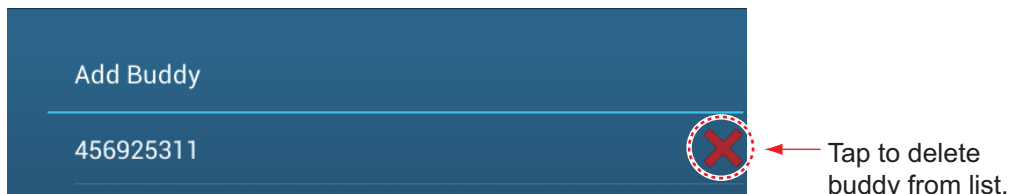

4. You are asked if you are sure to delete the buddy. Tap [OK].
5. Tap the close button on the title bar to finish.

14.13 CPA Graphic Display

The CPA graphic display, which requires own position and heading data, draws a line between own ship position and the selected AIS target to help you monitor an AIS target's heading and speed changes. The display is useful as an anti-collision aid, especially in congested waters.

To activate or deactivate the CPA graphic display, open the [Targets] menu, then turn on [CPA Graphic Display].

To find the CPA of an AIS target on the radar or chart plotter display, tap the AIS target. The CPA line connects with the position of your vessel and the CPA of the AIS target, and its color is the same as the color of the AIS target's symbol. The example below shows the appearance of the graphic display on the chart plotter display.

If the CPA/TCPA alarm is generated while the CPA line is in use, the CPA line and the selected target's symbol turn red.

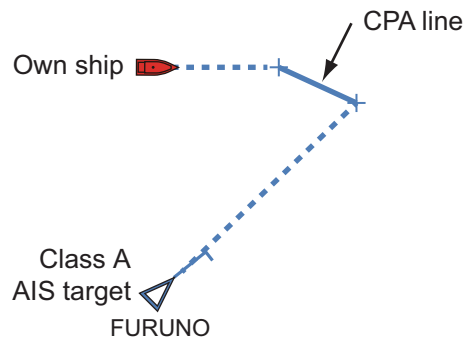

The CPA graphic display is deactivated (erased) in the following conditions:

- The CPA line is turned off. The line can be turned off by tapping the CPA line (or own ship icon* or target) to show the pop-up menu, then select [CPA].
* Chart plotter display only
- The TCPA is a minus (-) value.
- The AIS target is a lost target.
- The speed and heading data from the AIS target are lost.
- The CPA and TCPA of the AIS target cannot be calculated because speed and heading data become lost.
- No own ship speed or heading.

14.14 AIS Transponder FA-30, FA-50

The FURUNO AIS Transponder FA-30 (or FA-50) installs in the NavNet TZtouch3 network and can be controlled from a NavNet TZtouch3 display. To access the menu for the transponder, do as shown below. See the respective operator's manual for details.

1. Connect the FA-30 (or FA-50) to the NavNet TZtouch3 network.
2. Open the Home screen, then tap [Settings]→[Initial Setup]→[FA30 Browser] (or [FA50 Browser]).

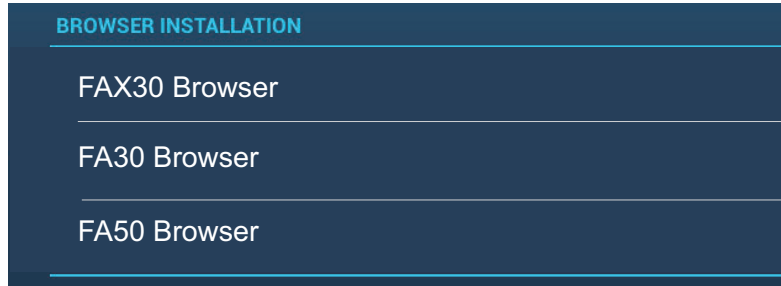

↓ Select an
"FA" browser

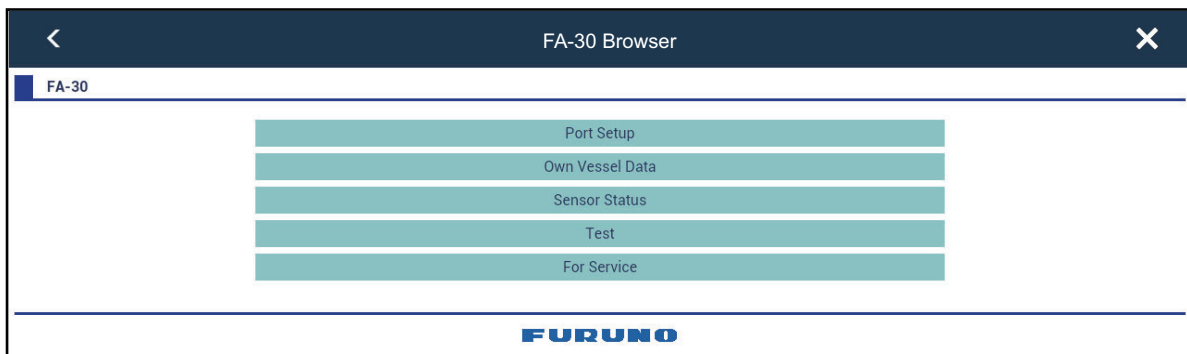

OR

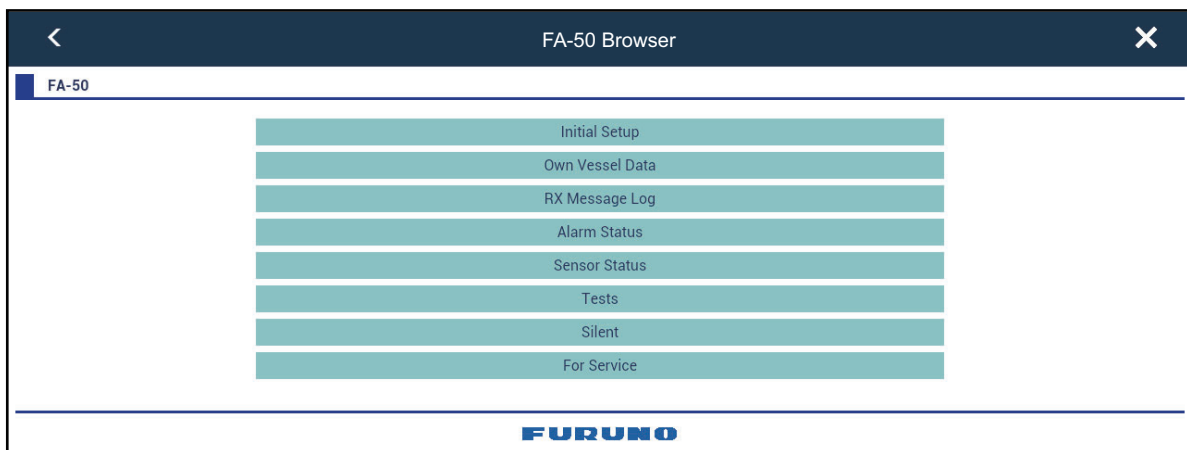

3. See the Operator's Manual for the FA-30 (FA-50) for operating procedures.

14.15 DSC Message Information

The DSC (Digital Selective Calling) message information feature provides, on the chart plotter and radar displays, the MMSI no. and position* of the ships that have transmitted a DSC message to you. A hexagon-shaped marker marks the position of the ship at the time the DSC was transmitted to you. The marker is color-coded according to the type of DSC message sent, red for distress and green for non-distress.

* Position at the time of message transmission. Position information is not updated.

Red: DSC marker for a distress message

Green: DSC marker for a non-distress message

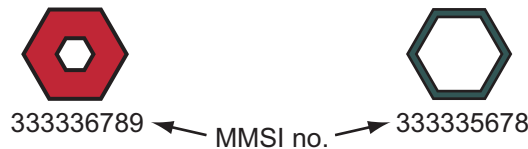

This feature requires connection of a DSC capable radiotelephone that outputs the DSC sentence in NMEA 2000 format.

14.15.1 DSC distress message

When a DSC distress message is received, the message "DSC Distress Call received" appears flashing in the Status bar. To delete the distress message, tap the Status bar.

14.15.2 How to set a DSC marker as destination

Tap the DSC marker, then tap [Go To] on the pop-up menu.

14.15.3 How to display DSC marker information

Tap a DSC marker to display the simple information (position, MMSI no. of the ship that transmitted a DSC message, etc.). To get detailed information, tap a DSC marker, then tap [Info] on the pop-up menu.

MMSI	121161120
COG	352.1 °M
SOG	0.0 kn
Range	11.94 NM
Bearing	315.0 °
CPA	11.76 NM
TCPA	6'14s
Last Update	0'00s
Goto	
New Point	
New SAR Pattern	
Info	

Simple information

Nickname 	
MMSI	121161120
COG	352.1 °M
SOG	0.0 kn
CPA	11.76 NM
TCPA	6'14s
Range	11.94 NM
Bearing	315.0 °
Last Update	0'00s
Lat	N 20°12.000'
Lon	W 110°00.000'
Nature Of Distress	Emergency Position Indicating Radio Beacon Emission

Detailed information

14.15.4 The DSC list

When a DSC message is received, it is automatically saved to the [DSC] list. On the screen, the MMSI number can be changed to a specified character string, such as the name of the ship, in order to quickly identify which ship sent you a message.

How to display the DSC list

Open the Home screen, then tap [Lists]→[DSC]. The colored bar before each entry denotes DSC message type, red for distress, green for non-distress.

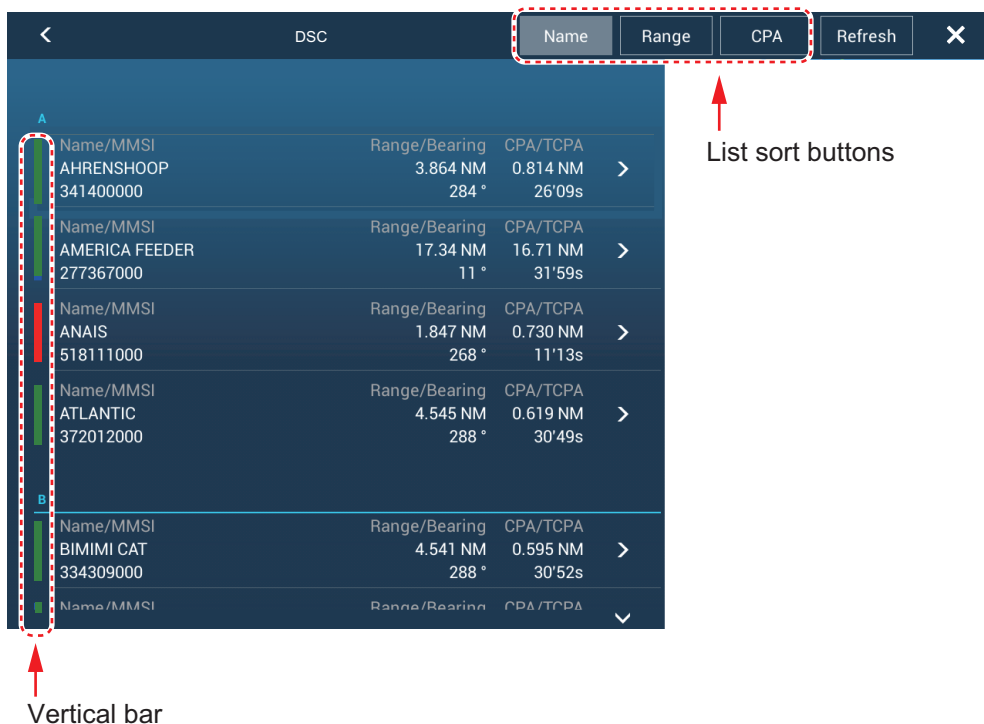

The title bar has buttons for sorting the list.
[Name]: DSC targets sorted in alphanumeric order.
[Range]: DSC targets sorted by range in ascending order.
[CPA]: DSC targets sorted by CPA in ascending order.

Note: To update the list, tap [Refresh].

How to show detailed information about a DSC marker

Tap the target on the [DSC] list to show its detailed information.

TARGET INFO	
NickName	
MMSI	387654321
COG	0.0 °
SOG	0.0 kn
CPA	1,840 NM
TCPA	-10d00h
Range	7,521 NM
Bearing	274 °
Last Update	31'27s
Lat	N 24°26.000'

This page is intentionally left blank.

15. OTHER FUNCTIONS



Once you have become acquainted with your equipment, you can set it according to your needs. You can change system configuration, change how the equipment operates and displays information, etc.

15.1 General Menu

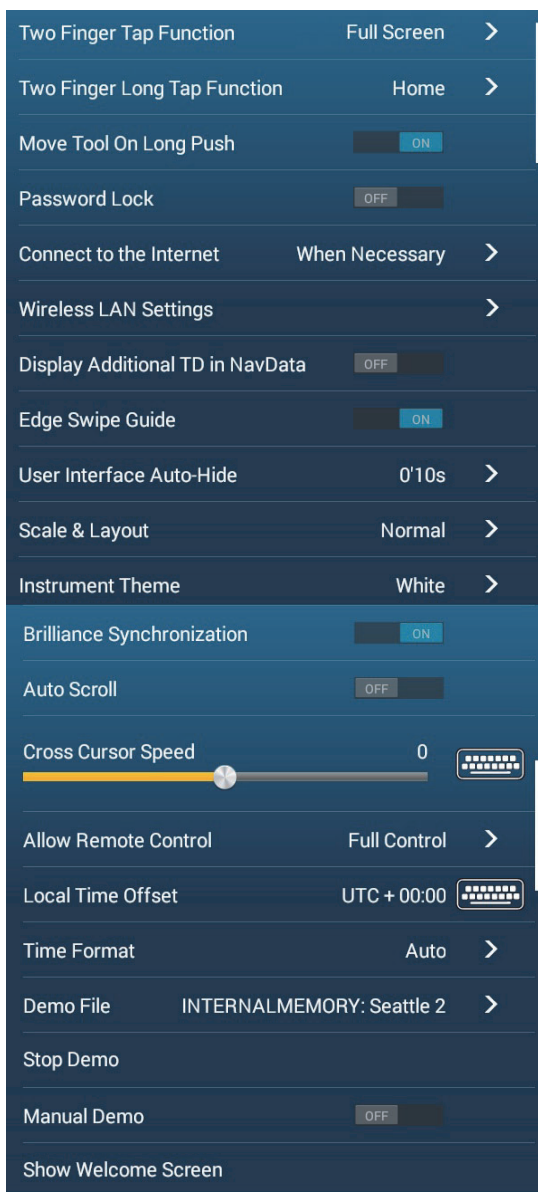
This section describes the [General] menu items not described in other chapters. Open the home screen, then tap [Settings]→[General] to display the [General] menu.



15. OTHER FUNCTIONS

Menu item	Function	Options
[Move Tool On Long Push]	Enable the "move" function with long-push of an object. Applicable to; <ul style="list-style-type: none"> • Points/event mark icons (excluding Sounder) • Route waypoints • Guard zone • EBL/VRM 	[OFF], [ON]
[Display Additional TD in Nav-Data]	In the [ON] setting, the TD information is added to the own ship's position in the data area. <div style="text-align: center;">  <p style="margin-left: 100px;">TD (time difference) information</p> </div>	[OFF], [ON]
[Edge Swipe Guide]	When you switch the display screen, or close the menu or list and return to the display screen in the [ON] setting, the indication shown below appears for about 15 seconds at the top, bottom, left and right of the screen. When swiping the indication, the functions appear (see section 1.8). The indication disappears when you operate the screen. <div style="text-align: center;">  </div>	[OFF], [ON]
[User Interface Auto-Hide]	Select the timeout for the following menus and the home icon on the camera/instrument screen (full screen). <ul style="list-style-type: none"> • Layers menu • Slide-out menu • Pop-up menu • Quick page Note: The home icon always appears on the split screen camera/instrument display and other displays.	[0'03s], [0'05s], [0'10s], [0'15s]
[Auto Scroll]	In the [ON] setting, the chart is appropriately and automatically scrolled when the cursor goes out of the display area.	[OFF], [ON]
[Cross Cursor Speed]	Adjust the cross cursor speed.	-7 to +7
[Allow Remote Control]	Set the permission level for NavNet Remote. <p>[Off]: Connection with NavNet Remote not allowed.</p> <p>[View Only]: Can view the screen remotely, but cannot operate and functions.</p> <p>[Full Control]: Can operate the entire system by remote.</p>	[Off], [View Only], [Full Control]
[Local Time Offset]	Select the time difference between local time and UTC time.	UTC -12:00 to UTC +13:00 (at 15 minute intervals)
[Time Format]	Select how to display time, in 12 or 24 hour format. [Auto] automatically inserts AM, PM indication in 24 hour clock, when the language is English.	[Auto], [24 Hours], [12 Hours]
[Demo File]	Select the demo file (internal or external) to use in the demo mode. For external data, set the applicable media in the SD Card Unit or the USB port.	
[Stop Demo]	Stop the demo mode selected at [Demo File].	-

Menu item	Function	Options
[Manual Demo]*	[OFF]: Use the data file selected at [Demo File]. Your vessel moves according the data in the data file. [ON]: Your vessel moves at the speed set at [Demo Speed] below.	[OFF], [ON]
[Show Welcome Screen]	Show the welcome screen.	-
[Show Welcome Screen at startup]	In the [ON] setting, the welcome screen appears at startup.	[OFF], [ON]
[Demo Slide Show]	No use.	[OFF], [ON]
[Demo Speed]	Set the ship's speed to use in the demo mode, when [Manual Demo] is [ON].	0 to 50 kn
[Check for Software Update]	Checks if your software is up-to-date. See section 15.5.	-
[Reset Default Settings]	Restore default settings for the items of the [General] menu.	-

* In the demo mode, chart plotter display, you can relocate the own ship icon to the location tapped. Tap the screen where you want to relocate the own ship icon, then tap [Move Boat] on the pop-up menu.

15.2 Units Menu

The [Units] menu sets the unit of measurement for speed, distance, depth, etc. Open the home screen, then tap [Settings]→[Units] to display the [Units] menu.



15. OTHER FUNCTIONS

Menu item	Options
[Bearing Display]	The mode (magnetic or true) of all heading and bearing data. [Magnetic], [True]
[True Wind Calculation Reference]	Select wind value to display from speed over ground or speed through water (surface). [Ground], [Surface]
[Position Format]	Select position format. [DDD°MM.mmmm'], [DDD°MM.mmm'], [DDD°MM.mm'], [DDD°MM'SS.ss''], [DDD.ddddd°], [Loran-C], [MGRS].
[Loran C Station &GRI]	Enter Loran C Station and GRI. Available when [Position Format] is selected to [Loran-C].
[Short/Long Change Over]	Set the distance at which to switch between short and long range (setting range: 0.0 to 2.0 NM). If the setting is 0.5, for example, short range is automatically selected when the long range unit is 0.4 or less. The setting "0.0" fixes the unit to long range.
[Range (Long)]	Select the unit for the long range. [Nautical Mile], [Kilometer], [Mile]
[Range (Short)]	Select the unit for the short range. [Foot], [Meter], [Yard]
[Depth]	Select the unit for the depth. [Foot], [Meter], [Fathom], [Passi Braza]
[Height/Length]	Select the unit for the height and length. [Foot], [Meter]
[Fish Size]	Select the unit for the fish size. [Inch], [Centimeter]
[Fish Weight]	Select the unit for the fish weight. [Pound], [Kilogram]
[Temperature]	Select the unit for the temperature. [Fahrenheit Degree], [Celsius Degree]
[Boat Speed]	Select the unit for the boat speed. [Knot], [Kilometer per Hour], [Mile per Hour], [Meter per Second]
[Wind Speed]	Select the unit for the wind speed. [Knot], [Kilometer per Hour], [Mile per Hour], [Meter per Second]
[Atmospheric Pressure]	Select the unit for the atmospheric pressure. [HectoPascal], [Millibar], [Millimeter of Mercury], [Inch of Mercury]
[Oil Pressure]	Select the unit for the oil pressure. [KiloPascal], [Bar], [Pound per Square Inch]
[Volume]	Select the unit for the volume. [Gallon] (Gallon & Gallon/Hour), [Litre] (Litre & Litre/Hour)
[Reset Default Settings]	Restore default settings for the [Units] menu.

15.3 Initial Setup Menu

The [Initial Setup] menu, which is mainly for use by the installer of the equipment, sets up the system according to the sensors connected. These adjustments require some knowledge of marine electronics equipment. If you are unsure of your abilities, have a qualified marine electronics technician make the adjustments. Inadequate adjustment can affect performance.

Open the home screen, then tap [Settings]→[Initial Setup] to display the [Initial Setup] menu. For the [FUSION] section, see section 11.3.

[GPS POSITION] section

Menu item	Description	Options (setting range)
[Longitudinal (from bow)]	Enter the GPS antenna positioning bow-stern (Longitudinal) and port-starboard (Lateral) position from the origin.	0 to 3,275 ft
[Lateral (-Port)]		-320 to 320 ft



[BOAT INFORMATION] section

Menu item	Description	Options (setting range)
[Boat Length]	Set the length of your boat.	0 to 3,278 ft
[Boat MMSI]	Set the MMSI of your boat.	Maximum of nine characters
[Boat Name]	Set the name of your boat.	Maximum of 32 characters
[Size of Own Ship Icon]	Set the size of own ship icon.	50 to 150
[Depth Display]	Select the start point for depth measurement.	[Under Keel], [Under Sea Level]
[External Transducer Draft]	Set the draft external transducers other than internal fish finder, networked or multi-beam sonar. For internal/network transducers , set the draft from the home screen→[Settings]→[Fish Finder]→[Transducer Draft]. For multi-beam sonars , set the draft from the home screen→[Settings]→[Multi Beam Sonar]→[Initial Setup]→[Transducer Draft].	0.0 to 99.9 ft
[Keel Draft]	Set the keel draft.	0.0 to 99.9 ft

[INSTRUMENTS SETUP] section

Menu item	Description
[Engine & Tank Automatic Setup]	The system will automatically detect engines and tanks connected to the same network.
[Engine & Tank Manual Setup]	If the system does not automatically detect engines and tanks, set the engines and tanks manually. See "Engine & Tank Manual Setup" below.
[Graphic Instruments Setup]	<ul style="list-style-type: none"> • See "Graphic Instruments Setup" below. • [Reset Instrument Pages]: Restore all instrument pages. • [Reset Default Settings]: Restore default settings for the [Graphic Instruments Setup] menu.

[Engine & Tank Manual Setup]:

Menu Item	Description	Options (setting range)
[Nickname]	Change the nickname for the engine or tank.	
[Used For Propulsion]	Select which engine/tank is used to calculate the distance which may be traveled using the remaining fuel. [ON] uses the engine/tank for calculations, [OFF] ignores the engine/tank.	[OFF], [ON]
[Reset]	Resets the engine/tank details to default.	

[Graphic Instruments Setup]:

[Graphic Instruments Setup] - [Maximum Boat Speed]. [Maximum Wind Speed]

Menu Item	Description	Options (setting range)
[Maximum Boat Speed]	Set the transducer's maximum detectable speed.	1 to 99 kn
[Maximum Wind Speed]	Set the transducer's maximum detectable speed.	1 to 99 kn

[Graphic Instruments Setup] - [DEPTH]

Menu Item	Description	Options (setting range)
[Minimum Depth]	Set the transducer's minimum detectable depth.	0 to 6,558 ft
[Maximum Depth]	Set the transducer's maximum detectable depth.	4 to 6,560 ft

[Graphic Instruments Setup] - [SEA SURFACE TEMPERATURE]

Menu Item	Description	Options (setting range)
[Minimum Sea Surface Temperature]	Set the transducer's minimum detectable temperature.	32.00 to 89.97°F
[Maximum Sea Surface Temperature]	Set the transducer's maximum detectable temperature.	33.01 to 210.00°F

[Graphic Instruments Setup] - [PROPULSION ENGINE]/[OTHER ENGINE]

Menu Item	Description	Options (setting range)
[Max. RPM]	Set the maximum rpm of your engine to show on the RPM display.	1 to 20,000 rpm
[Red Zone Oil Pressure]	Set the starting value for the red zone area of the oil pressure meter.	0 to 998 kPa
[Max. Oil Pressure]	Set the maximum oil pressure of your engine.	1 to 999 kPa
[Min. Temperature]	Set the minimum temperature for your engine.	32.0 to 210.0°F
[Red Zone Temperature]	Set the starting value for the red zone area of the engine temperature indicator.	32.0 to 999.9°F

[Graphic Instruments Setup] - [CZONE SETUP]

Menu item	Description
[Add Default CZone Pages]	Create, edit C-Zone pages.
[CZone DIP Switch Settings]	Set this unit's DIP switches. For the serviceman. Do not change the settings.

Menu item	Description
[Reset Instrument Pages]	Restore all instrument pages.
[Reset Default Settings]	Restore default settings for the [Graphic Instruments Setup] menu.

[HOME PAGE] section

Menu item	Description
[Factory Reset]	Restore the home page.

[MANUAL FUEL MANAGEMENT] section

Menu item	Description	Options (setting range)
[Total Fuel Capacity]	Enter the total fuel capacity of your tank(s).	0 to 9,999 L
[Manual Fuel Management]	Set to [ON] for manual fuel management.	[OFF], [ON].

[IF-NMEAFI SETUP] section

Menu item	Description	Options (setting range)
[Select IF]	Select [IF-NMEAFI] to set the analog data that is input from the IF-NMEAFI. These settings are reflected after restarting the IF-NMEAFI.	
[Category]	Select the category for the analog sensor to set.	[Wind], [ST800_850], [Fuel], [Fresh Water], [Waste Water], [Live Well], [Oil], [Black Water]
[Resistance Full]	The resistance, in Ohms, when the tank is full.	0 to 300 Ohm
[Resistance Mid]	The resistance, in Ohms, when the tank is half full.	0 to 300 Ohm
[Resistance Empty]	The resistance, in Ohms, when the tank is empty.	0 to 300 Ohm
[Capacity]	The capacity of the tank.	0 to 2650 G
[Fluid Instance]	Set tank NMEA2000 instance number.	0 to 5
[Self test]	Test results are displayed.	

15. OTHER FUNCTIONS

Menu item	Description	Options (setting range)
[Set Hardware To Factory Default]	Resets the converter selected at [Select IF] to factory default.	

[DATA ACQUISITION] section

Menu Item	Description	Options (setting range)
[GP330B WAAS Mode]	Select [ON] to use the WAAS mode for the corresponding GPS antenna.	[OFF], [ON]
[WS200 WAAS Mode]		
[Data Source]	Select the source for each data to input to the system. If two or more sources are connected for a data, select one using the pull-down dialog box. (FURUNO sensors are shown at the upper part of the list.)	
[Sensor List]	Show the information for sensors connected to your equipment. Tap the sensor to show the detailed information. You can edit the items with  icons on the right side of the screen. Note: If you change each instance value, you need to restart its sensor.	
[NMEA0183 Output]	[PORT CONFIGURATION] section:	[OFF], [ON]
	<ul style="list-style-type: none"> • [Baudrate]: Select the baudrate. • [NMEA-0183 Version]: Select the version for NMEA0183. 	
	[SENTENCES] section:	
	Select [ON] for the NMEA sentences to output. Note: When outputting the TTM sentence and another sentence at the same time, the number of TTM targets output may be reduced due to the communication bandwidth restrictions.	
[NMEA 2000 PGN Output]	Select [ON] for the PGNs (Parameter Group Number, CAN bus (NMEA2000) message) to output from the CAN bus port.	[OFF], [ON]
[Sky View...]	Show the condition of GPS and GEO (WAAS) satellites on the [GPS SkyView] display. The bearing and elevation angle of all GPS and GEO satellites (if applicable) in view of your receiver appear. For the serviceman. Note: The [GPS SkyView] display can also be shown by tapping the GPS icon (shown right) on the home screen.	



[INTERNAL GPS SETUP] section (TZT9F/12F/16F only)

Menu Item	Description	Options (setting range)
[WAAS Mode]	Select [ON] to use the WAAS mode.	[OFF], [ON]

[NMEA2000 LOG] section

Menu Item	Description	Options (setting range)
[Enable NMEA2000 Log]	Select [ON] to storage the NMEA2000 data.	[OFF], [ON]
[NMEA2000 Log Storage Location]	Select where to storage the data.	

[SC-30 SETUP] section (only when the SC-30 is connected)

Menu item	Description	Options (setting range)
[WAAS Mode]	Select [ON] to use the WAAS mode.	[OFF], [ON]
[Heading Offset]	Enter the offset value for heading.	-180 to +180°
[Pitch Offset]	Enter the offset value for pitching.	-90 to +90°
[Roll Offset]	Enter the offset value for rolling.	-90 to +90°

[NETWORK SENSOR SETUP] section

The [NETWORK SENSOR SETUP] section allows you to set up compatible FURUNO NMEA2000 sensors. Calibrations and offsets applied in this menu are also applied to the sensor itself.

[CALIBRATION] section

Menu item	Description	Options (setting range)
[Heading]	Offset heading data.	-180.0 to +180.0°
[Speed Through Water]	Calibrate speed data. Enter amount in percentage.	-50 to +50%
[Wind Speed]	Offset wind speed data. Enter amount in percentage.	-50 to +50%
[Wind Angle]	Offset wind angle data.	-180.0 to +180.0°
[Sea Surface Temperature]	Offset sea surface temperature data.	-50 to +50°F

[DATA DAMPING] section

Menu item	Description	Options (setting range)
[COG & SOG]	Set data damping time. The lower the setting the faster the response to change.	0 to 59 seconds
[Heading]		
[Speed Through Water]		
[Wind Speed&Angle]		
[Rate of Turn]		

[FUSION] section

Menu item	Description	Options (setting range)
[Connect to Fusion]	Connect to your Fusion equipment.	
[Fusion Auto Volume]	Set to [ON] to allow this unit to control the Fusion volume automatically.	[OFF], [ON]
[Minimum Speed]	Set the minimum speed threshold. Exceeding this speed activates volume auto control.	0 to 99 kn
[Maximum Speed]	Set the maximum speed threshold.	0 to 99 kn
[Volume Increase]	Set the amount of extra volume to output.	10 to 50%

[BROWSER INSTALLATION] section

Menu item	Description
[FAX-30 Browser]	Show the Facsimile Receiver FAX-30 display.
[FA-30 Browser]	Show the AIS Receiver FA-30 display.
[FA-50 Browser]	Show the AIS Receiver FA-50 display.

Others menu items

Menu item	Description	Option (setting range)
[Chart Master Device]	Set to [ON] to set this equipment as the chart master ([OFF]: sub).	[OFF], [ON]
[System ID]	The system ID for this device within the network.	
[IP Address]	IP address for this unit within the network.	
[Synchronization Log]	Synchronization log for this unit within the network.	
[Quick Self Test]	Information for this equipment and connected sensors.	
[Certification Mark]	Show the certification marks this equipment has received.	
[Service]	Requires login password. For the service technician only.	
[Event Input Configuration]	Select the data to be entered as an event.	[Off], [Event Mark], [MOB], [Ferry]
[Update Network Equipments]	Updates all NavNet equipment in the network. For the service technician.	
[Sirius Radio Diagnostic]	Check the satellite radio of the FURUNO BBWX weather receiver for proper operation. See section 13.7.3.	
[Sirius Weather Diagnostic]	Check the weather section of the FURUNO BBWX weather receiver for proper operation. See section 13.6.	
[Restores Default Settings]	Restore default settings for the [Initial Setup] menu.	

15.4 Facsimile Receiver FAX-30

The FURUNO Facsimile Receiver FAX-30 installs in the NavNet TZtouch3 network and can be controlled from a NavNet TZtouch3 display. Below are the steps to start fax operation.

1. Connect the FAX-30 to the NavNet TZtouch3 network.
2. Open the home screen, then tap [FAX-30] (left side of screen).



3. Tap [WX FAX] or [NAVTEX].

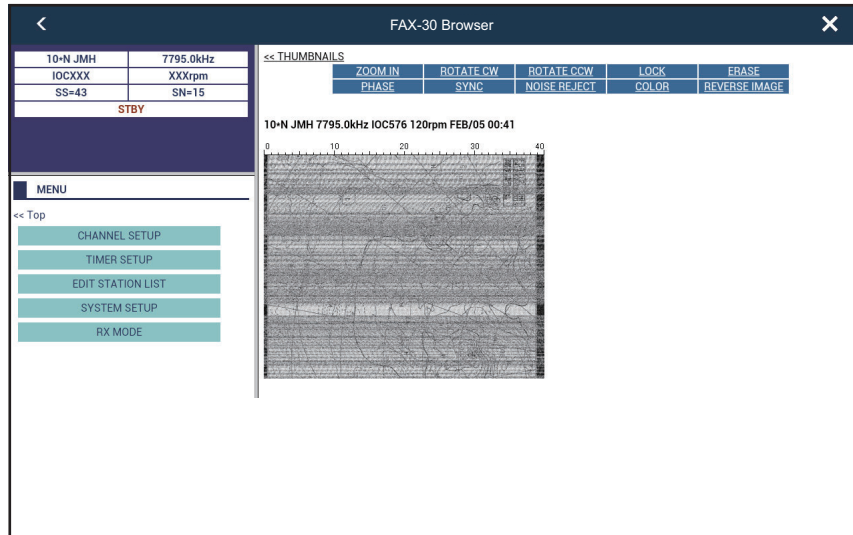

4. Refer to the Operator's Manual of the FAX-30 for operation information.

The FAX-30 display can only be accessed by one NavNet TZtouch3 unit at a time. When another NavNet TZtouch3 display accesses the FAX-30, control of the FAX-30 is given to that display after the picture has stopped completely. This sequence takes approximately one minute.

15.5 How to Check for Software Updates

You can check for software updates via the internet.

1. Referring to section 1.19, connect to the internet.
2. Open the home screen, then tap [Settings]→[General]→[Check for Software Update]. The following window appears.

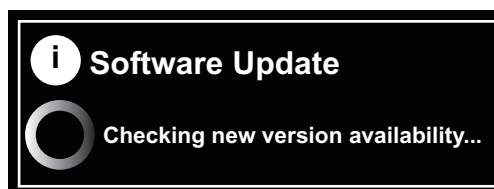

After the checking is completed, one of the following messages appears:

- When your unit has the latest software: "THE LATEST SOFTWARE IS INSTALLED ON THIS DEVICE."
 - When newer software is available: "A SOFTWARE UPDATE IS AVAILABLE. PLEASE VISIT NAVNET.COM TO DOWNLOAD IT."
3. Tap the [OK] button.
 4. Tap the close button on the title bar to finish.

15.6 How to Manage Your Charts

The NavNet TZtouch3 uses the Mapmedia charts. There are two types of charts: free and paid. When using paid charts, an unlock code is required. To share the system ID and unlock code in the NavNet TZtouch3 network, open the home screen, then tap [Settings]→[Initial Setup]→[ON] for [ChartMaster Device] of one NavNet TZtouch3. The NavNet TZtouch3 uses the same Mapmedia charts as NavNet 3D. Even though NavNet TZtouch3 is a master-less system in networking, for charts one NavNet TZtouch3 unit should be set as Chart Master to share the System ID, which will be necessary to obtain a chart unlock code from Mapmedia. Chart Master Device





Note: When two or more NavNet TZtouch3s share an unlock code, you need to get an unlock code again if changing the setting of [Chart Master Device]. For example, if the NavNet TZtouch3 that was used as the “primary” ([Chart Master Device] setting: [ON]) is used as the “secondary” ([Chart Master Device] setting: [OFF]) (and vice versa), the unlock code must be reacquired. Is required. For details, see “Chart is not displayed after changing chart master settings.” on page 16-4.

15.6.1 How to view your charts

Tap the Home icon to show the home screen, then tap [Charts] to display your charts catalog.

The screenshot displays the 'Charts Catalog' interface. At the top, there are buttons for 'Download Codes', 'Filter', 'Insert Code', and 'System ID'. Below these is a table of charts. The table has columns for 'Chart file name', 'Chart file type', 'Chart version no.', 'Chart manufacturer', and 'Trash icon'. Annotations with red dashed lines point to these columns and specific elements within the table.

Chart file name	Chart file type	Chart version no.	Chart manufacturer	Trash icon
SDVJWW00MAP02.DBV	Vector charts	2.0	C-MAP	🗑️
SDWW00VMAP04.DBV	Vector charts	4.0	Datacore by Navionics	🗑️
SDWW00VS57MAP04.DBV	Vector charts	4.0	HO S-57	🗑️
SDWW00RMAP01.DBR	Raster charts	1.0	MapMedia	🗑️
SDWW00LSAT01.DBA	Photos	1.0	MapMedia	🗑️
SDWW00TIN01.DBT	3D	1.0	MapMedia	🗑️
SDNA01MET01.DBM	Unknown chart	1.0	MapMedia	🗑️
SDWW00CRT01.DBP	Tidal currents	1.0	MapMedia	🗑️
SDWW00FISHMAP04.DBB	Fishing charts	4.0	MapMedia	🗑️
SDWW00TIDES12.DBS	Tides	12.0	MapMedia	🗑️

Chart status icon	Meaning	Chart status icon	Meaning
	Free chart. An unlock code is not necessary.		Paid chart. Unlock code entered.
	Paid chart. Unlock code is necessary to use the chart. Tap [Insert Code] at the top of the [Charts Catalog] screen. Enter the unlock code then tap [✓] to finish.		Chart cannot be used because it is corrupted.

How to hide unnecessary charts on the chart catalog list

1. Tap [Filter] on the chart catalog list title bar to show the [Filter charts] window.
2. Select [OFF] for the items that you want to hide. The factory setting shows all charts. To restore all charts, tap [Reset Filters].
3. Tap < on the title bar to return to the chart catalog list. [Filter] on the title bar changes to [Change Filter].
4. Tap the close button to close the chart catalog list.

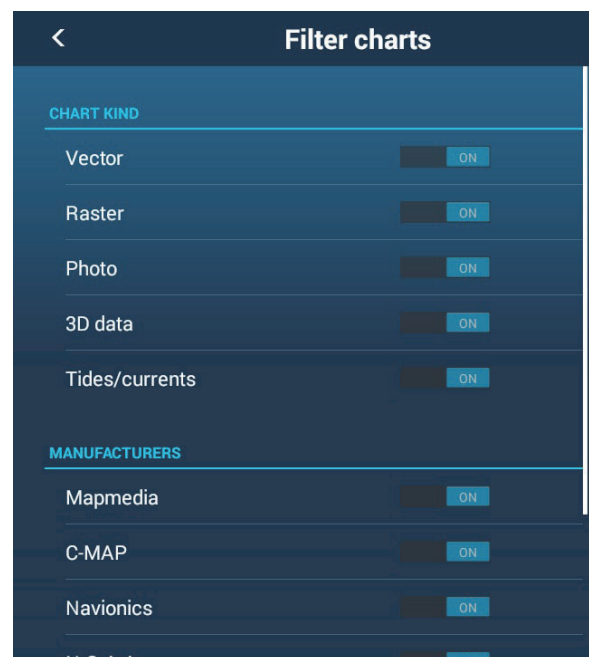

15.6.2 How to update or add charts

Free (USA and NOAA) and for-fee NavNet TZtouch3 compatible charts are provided by FURUNO and Mapmedia. Go to the URLs shown below to download chart data.

Download the chart file to your desktop. Unzip the file, then copy it to the root of a microSD card. Insert the card into the SD card slot on the display unit, or a slot in the SD Card Unit (SDU-001). For the detailed procedure, refer to the instructions on the FURUNO website.

A for-fee chart requires that you enter its chart unlock code. Go to the Home screen and tap [Charts] to show the [Charts Catalog] display. Tap [Insert Code] then enter the chart unlock code from the software keyboard.

Where to obtain chart data:

Mapmedia

<http://www.mapmedia.com/charts-catalog.html>

15.6.3 How to delete charts

Before replacing a chart, you should delete the old chart data on every NavNet TZtouch3 unit. Only delete the chart data that you intend to replace or no longer require.

Open the charts catalog. Tap the trashcan icon of the chart to delete. You are asked "ARE YOU SURE YOU WANT TO DELETE THIS FILE?" Tap [OK] to delete the file.

16. MAINTENANCE, TROUBLE-SHOOTING

This chapter has information about maintenance and troubleshooting that the user can follow to care for the equipment.

WARNING

ELECTRICAL SHOCK HAZARD
Do not open the equipment.

Only qualified persons can work inside the equipment.

NOTICE

Do not apply paint, anti-corrosive sealant or contact spray to plastic parts or equipment coating.

Those items contain products that can damage plastic parts and equipment coating.

16.1 Maintenance

Routine maintenance helps keep your equipment in good condition and prevents future problems. Check the items shown in the table below on a regular basis to help keep your equipment in good condition for years to come.

Check item	Check point	Remedy
Cables	Cable connection, corrosion	Connect loosened cables. Replace any damaged cables.
Cabinet	Dust on the cabinet	Remove dust with a dry, clean cloth. Do not use commercial cleaners to clean the equipment - they can remove paint and markings.
LCD	Dust on the LCD	Wipe the LCD carefully to prevent scratching, using tissue paper and an LCD cleaner. To remove dirt or salt deposits, use an LCD cleaner, wiping slowly with tissue paper so as to dissolve the dirt or salt. Change paper frequently so the salt or dirt will not scratch the LCD. Do not use solvents such as thinner, acetone or benzene for cleaning. Also, do not use degreaser or anti-fog solution, as they can strip the coating from the LCD.
	Waterdrops on the LCD	Waterdrops on the LCD can slow touch response. Wipe the LCD with a dry, soft cloth to remove the water.
Radar antenna	Foreign material on the radar antenna	Foreign material can reduce sensitivity. Clean the antenna with a cloth wetted with freshwater. Do not use commercial cleaners to clean the radiator - they can remove paint and markings.
Transducer	Transducer face	Marine growth on the transducer face can reduce sensitivity. Remove any growth with a wooden stick or fine grade sandpaper.

16.2 Fuse Replacement

The fuse in the fuse holder in the power cable protects the equipment from high electric current and equipment fault. If you cannot turn on the power, check the fuse to see if it has blown. If the fuse has blown, Find the reason before you replace the fuse. If the fuse blows again after the replacement, contact your dealer for advice.



WARNING

Use the proper fuse.

Use of the wrong fuse can cause fire or electrical shock.

Name	Type	Code No.	Remarks
Fuse	FGBO-A 125V 5A PBF	000-155-853-10	For TZT9F
	FRU-60V-FU-4A	000-197-093-10	For TZT12F
	FRU-60V-FU-7.5A	000-197-094-10	For TZT16F/TZT19F

16.3 Life of Parts

Magnetron

When a magnetron reaches the end of its life, targets do not appear on the radar display. If long-range performance appears to have declined, contact your dealer about replacement of the magnetron.

Radar Sensor	Magnetron	Code No.	Approx. Life
DRS4DL	80-0691	001-266-460	5,000 hours
DRS4DL+	80-0691	001-266-460	5,000 hours
DRS6A X-Class	MAF1422B	000-158-788-12	5,000 hours
DRS12A X-Class	FNE1201	001-245-890	5,000 hours
DRS25A X-Class	MG5436	001-205-570	5,000 hours

The total time of power-on ("ON TIME") and transmission ("TX TIME") are displayed on the radar screen during the stand-by mode.

LCD

The life of the LCD is approximately 50,000 hours. The actual life of the LCD is affected by the operating environment (temperature, humidity, etc.). When nearing the end of its life-span, the LCD brilliance does not adjust correctly. When this occurs, contact your local dealer for advice.

Fan

The approximate life of the fan is as shown in the table below, and the actual life depends on ambient temperature. When the fan does not rotate sufficiently, an applicable message appears in the status bar. Turn off the power and contact your dealer about replacement of the fan.

Item	Type	Code No.	Estimated Life	Remarks
FAN MOTOR	MFB52A-12HA-002	000-175-998-10	Approx. 21,000 hours	For TZT9F, TZT12F, TZT16F, TZT19F (Internal fan)
	9WP0412H6004	000-197-035-10	Approx. 40,000 hours	For TZT19F (External fan)

16.4 Troubleshooting

This section provides simple troubleshooting procedures that the user can follow to restore normal operation. If you cannot restore normal operation, do not check inside the unit. Have a qualified technician check the equipment.

16.4.1 General troubleshooting

Problem	Remedy
You can not turn on the power.	<ul style="list-style-type: none"> • Check for blown fuse. • Check that the power connector is tightly fastened. • Check for corrosion on the power cable connector. • Check for the power cable for damage. • Check battery for correct voltage output. • For the TZT16F/TZT19F, use a bare finger to turn on the power. (The power cannot be turned with gloved hands.)
Picture is not displayed properly.	Turn the power off, then on again. If the picture is still improper, contact your local dealer for instructions.
The display has frozen.	Push the power switch until the power goes off. (For the TZT9F/12F, hold and press the power switch.)
No response after display is touched.	<ul style="list-style-type: none"> • Check if [Touch Screen] on the [Quick Access] window is locked. • Reset the power. If there is still no response, contact a FURUNO dealer for advice.

16.4.2 Chart plotter troubleshooting

Problem	Remedy
Position is not fixed.	<ul style="list-style-type: none"> • Check for interfering objects near the display unit that might be blocking reception. • Possible trouble with internal GPS antenna or GPS receiver. Contact a FURUNO dealer for advice. • Check if the connector at the back of the GPS receiver has loosened. Connect if loosened.
The track of your ship is not plotted.	Check if [Tracks] is turned on in the Layers menu.
Chart is not displayed after changing chart master settings.	<p>Connect to the internet to get the chart unlock code, as follows. then tap [Home]→[Catalog]→[Download codes]. The codes are automatically applied.</p> <ol style="list-style-type: none"> 1) If you are currently connected to the internet, disconnect from the internet. 2) Use the wireless LAN to connect to the internet (see section 1.19). After connecting to the internet, approx. one minute later you can obtain the unlock code. 3) If you cannot obtain the unlock code, contact a FURUNO dealer for advice.
Unlock code cannot be found.	Get the unlock code for the chart and cancel the unlock state (with the unit connected to the internet, [Home]→[Charts]→[Download Codes]). There is no need to enter the chart unlock code manually.

16.4.3 Radar troubleshooting

Problem	Remedy
The radar does not transmit when the [TX] icon is operated.	<ul style="list-style-type: none"> • Tap the [TX] icon again. • Check if the power cable, LAN cable are tightly fastened. • Check if the radar source is correctly set and connected.
Marks and characters appear, but echoes do not appear.	Check if the power cable, LAN cable are tightly fastened.
Picture is not updated or the picture freezes.	<ul style="list-style-type: none"> • Check if the power cable, LAN cable are tightly fastened. • Check if this unit is powered.
You adjusted the receiver gain, but radar echoes are too weak.	The life-span of the magnetron in the radar sensor is over. Have a technician check the magnetron.
You changed the range, but the radar picture does not change.	<ul style="list-style-type: none"> • Try to change the range again. • Reset the power.
Poor discrimination in range.	Adjust the sea control.
Range rings are not displayed.	Check if [Range Rings] is turned on in the Layers menu.
You tapped the [TX] icon to transmit. The "TX screen" appears momentarily, but the radar soon goes into stand-by.	The overload protection has activated. To restore normal operation, turn off all equipment in the network. Wait a few seconds then turn on all the equipment.

16.4.4 Fish finder troubleshooting

Problem	Remedy
You selected a fish finder display from the Home screen, but no picture appears.	<ul style="list-style-type: none"> • Check that the transducer cable is tightly fastened. • Check that the fish finder source is correctly selected. • Check if the fish finder is correctly connected. • Check if [Picture Advance] in the [Fish Finder] menu is set to [Stop].
Marks and characters appear, but no picture appears.	<ul style="list-style-type: none"> • Check that the transducer cable is tightly fastened. • Check if [Picture Advance] in the [Fish Finder] menu is set to [Stop].
Picture appears but zero line does not appear.	<ul style="list-style-type: none"> • The picture is shifted. Drag the picture up or down to show the zero line. • Check if the draft setting ([Settings]→[Fish Finder]→[Transducer Draft]) is zero (0) or higher.
The picture sensitivity is too low.	<ul style="list-style-type: none"> • If you are in the manual mode, check the gain setting. • Check the transducer face for marine life and air bubbles. • Bottom is too soft to return an acceptable echo.
The depth indication does not appear.	Adjust the bottom level.
Noise or interference shows on the display.	<ul style="list-style-type: none"> • Make sure the transducer cable is not near the engine. • Check the ground for tight connection, corrosion. • Check if another fish finder near your boat has the same frequency as your fish finder. • Try to reject the interference with [Interference Rejection] in the [Fish Finder] menu.

This page is intentionally left blank.

APPENDIX 1 MENU TREE

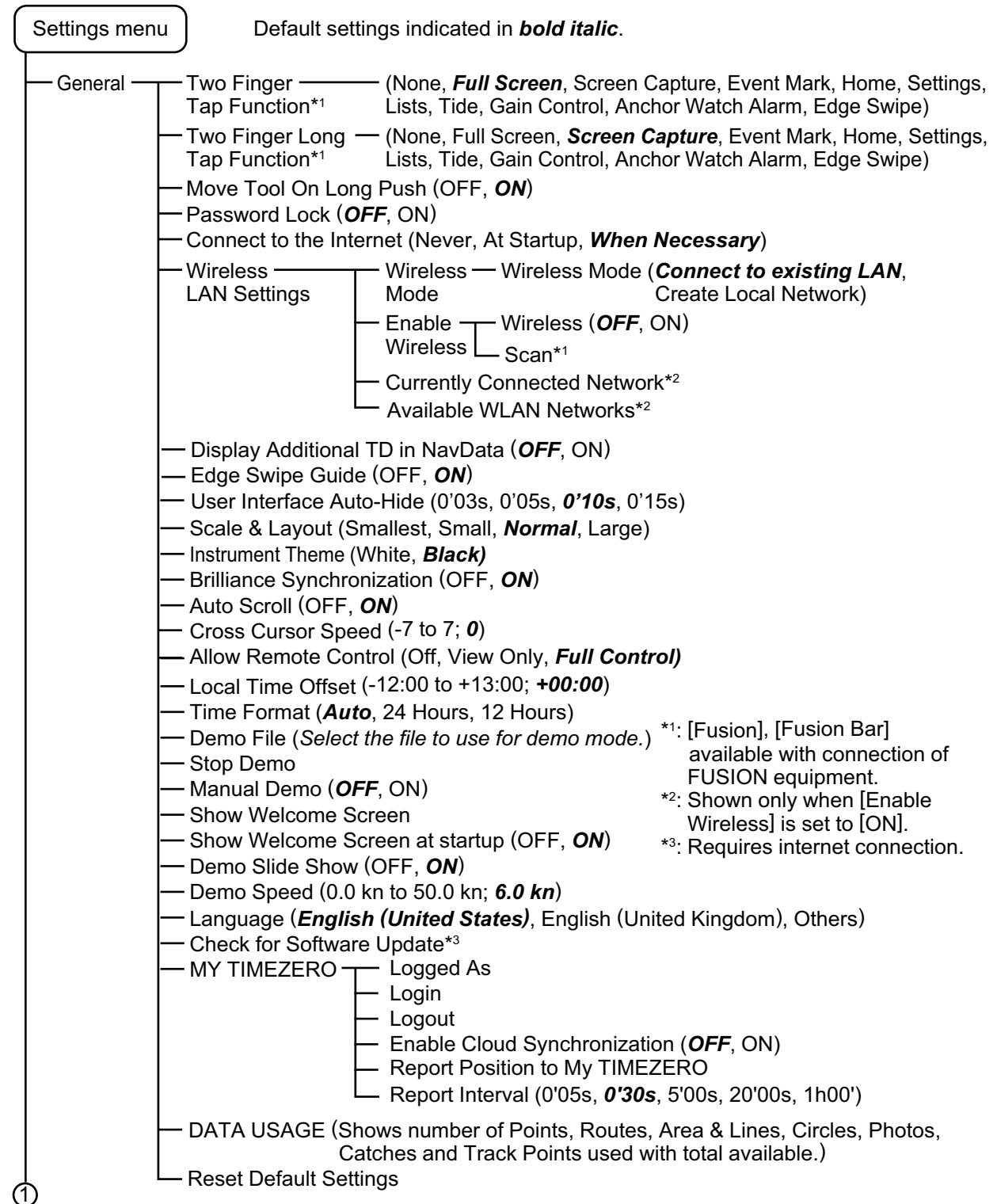

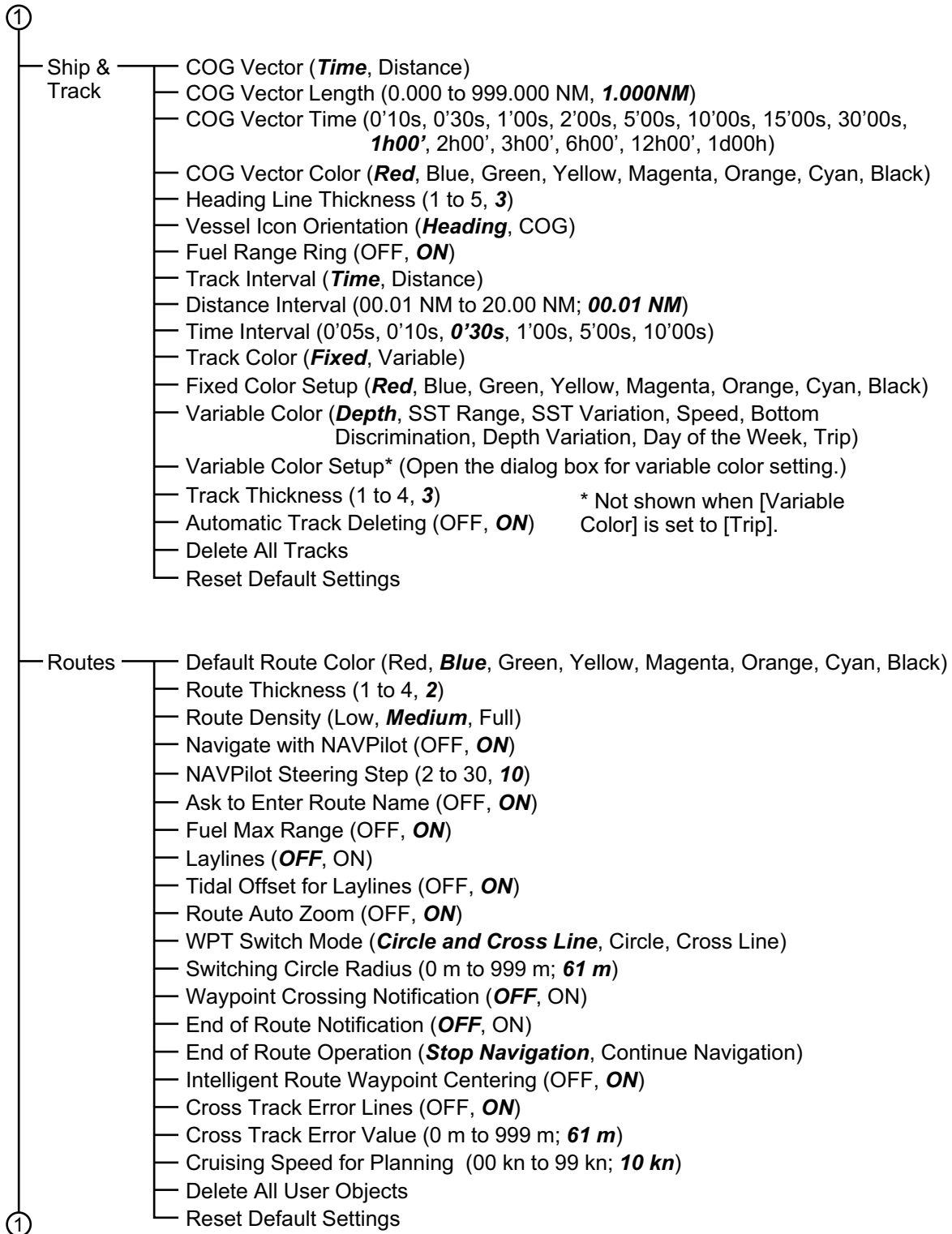

①

Points & Boundaries

- Default Point Symbol (see figure below)
- Default Point Color (Red, Blue, Green, **Yellow**, Magenta, Orange, Cyan, Black)
- Point Size (50 to 200; **100**)
- Icons Set (**Modern**, Classic)
- Point Density (Low, **Medium**, Full)
- Display Point Names (OFF, **ON**)
- Automatic Naming (OFF, **ON**)
- Automatic Naming Prefix (*Input from software keyboard*; default: **WP**)
- Data to Be Recorded in Event Comment (**None**, Date, SST, Date and SST)
- Record Event Mark 1 Automatically (**OFF**, ON)
- Default Event Mark x* Symbol (see figure below) * Event Mark 1~6
- Default Event Mark x* Color (Red, Blue, Green, Yellow, Magenta, Orange, Cyan, Black; *see figure below for defaults*)

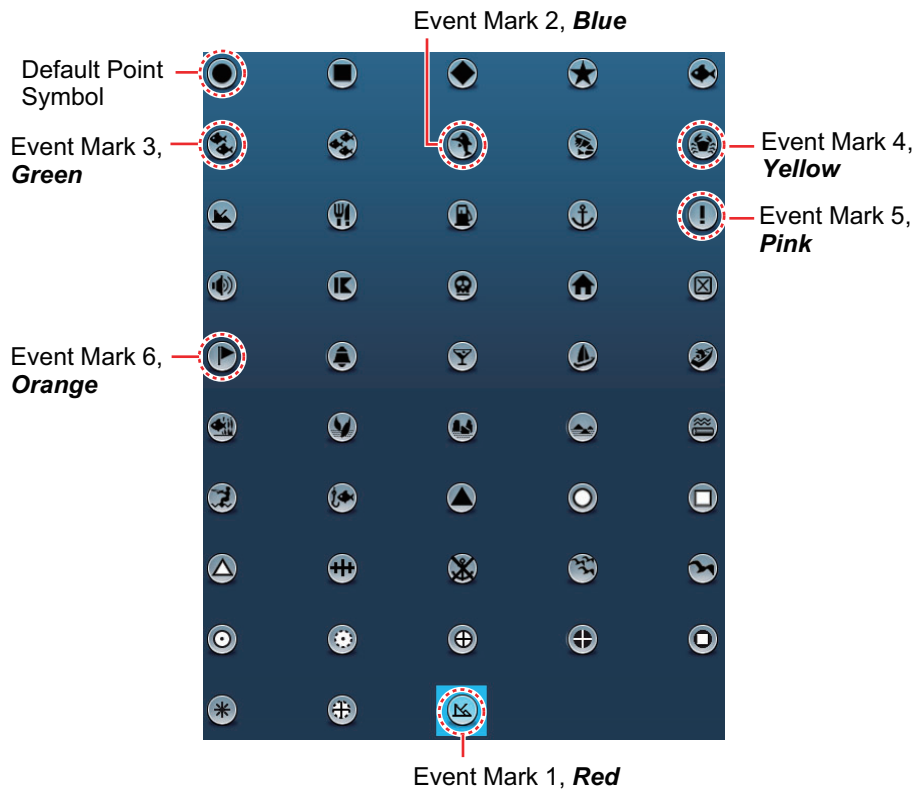





- Default Boundary Color (Red, Blue, Green, **Yellow**, Magenta, Orange, Cyan, Black)
- Default Boundary Transparency (0 to 100; **40**)
- Default Boundary Contour (, , , ; default: )
- Delete All User Objects
- Restore Default Settings

Chart Plotter

- Grid Interval (**Off**, Very Small, Small, Medium, Large, Very Large)
- Show Scale Slider (OFF, **ON**)
- Show Fish It on Pop-up Menu (OFF, **ON**)
- Tide/Current Icons Size (50 to 150; **100**)
- NavData Transparency (0 to 80; **10**)
- PhotoFusion Transparency (0 to 80; **15**)
- Tide Range for PhotoFusion (**0** m to 20 m; **0**)
- Tidal Currents Transparency (0 to 80; **25**)
- Radar Transparency (0 to 80; **20**)
- Range Link (**OFF**, ON)
- Echo Color (**Multicolor**, Green, Yellow)

①

② Continued on following page

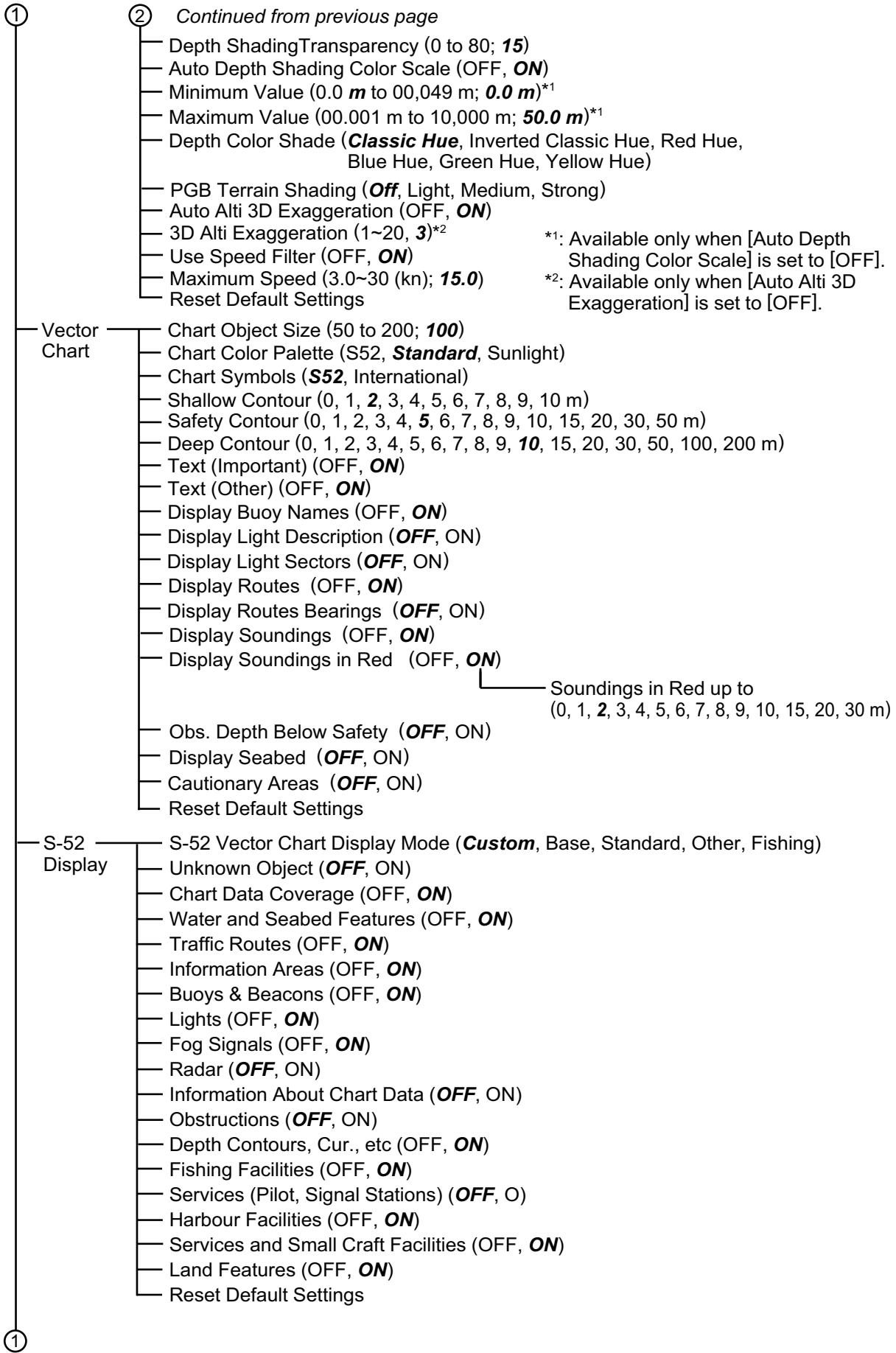

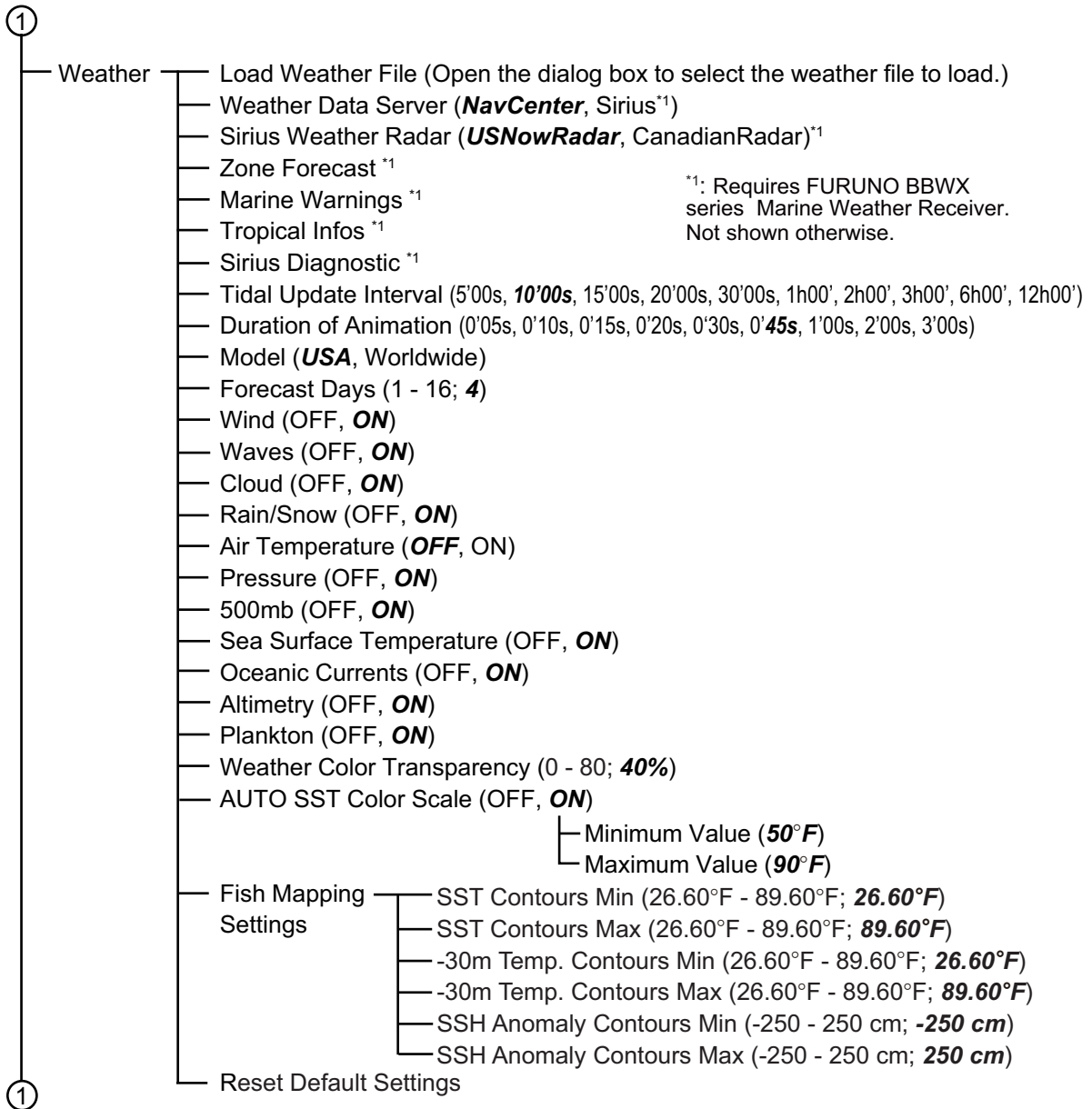

- ① Radar
 - Radar Source (Select the antenna host name.)
 - Day Background Color (**Black**, Dark Blue, White)
 - Night Background Color (**Black**, Dark Blue)
 - Echo Color (**Multicolor**, Green, Yellow)
 - Rings Interval (**Automatic**, 1 Ring, 2 Rings, 3 Rings, 4 Rings, 5 Rings, 6 Rings, 7 Rings, 8 Rings, 9 Rings)
 - Show Range Slider (OFF, **ON**)
 - Own Ship Icon (OFF, **ON**)
 - Bearing Scale Mode (**Relative**, True)
 - EBL Reference (True, **Relative**)
 - Watchman (**5'00s**, 10'00s, 20'00s)
 - Trail Color (**Blue**, Yellow, Green)
 - Trail Length (0'15s, 0'30s, 1'00s, **3'00s**, 6'00s, 15'00s, 30'00s, Continuous)
 - Trail Shade (Single, **Multi**)
 - Trail Mode (Relative, **True**)
 - Antenna Rotation (**Auto**, 24 RPM)
 - Antenna Heading Align (-179.9 - +180.0; **+0.0°**)
 - Main Bang Suppression (0 - 100; **50**)
 - Enable Sector (2)*¹ Blanking (**OFF**, ON)
 - Start Angle*² (0 - 359; **0**)
 - End Angle*² (0 - 359; **0**)
 - Longitudinal Position (from bow) (**20 ft**)
 - Lateral Position (-Port) (**0 ft**)
 - Antenna Height*³ (For DRS: Under 3 m, **3 m - 10 m**, Over 10 m)
(For IMO: 5 m, **7.5 m**, 10 m, 15 m, 20 m, 25 m, 30 m, 35 m, 40 m, 45 m, 50 m)
 - Antenna Length*⁶ (1.0m, **1.2m**, 1.8m)
 - Auto Tuning (OFF, **ON**)
 - Tuning Source*³ (**Range1**, Range2)
 - Manual Tuning*⁴ (**-50** to 50; **0**)
 - Radar Monitoring
 - Radar Optimization*⁵
 - ARPA Advanced Settings*³
 - TX Channel (**Auto**, 1, 2, 3)*⁶
 - Auto Acquire by Doppler (OFF, **ON**)*⁶
 - Set Hardware To Factory Default
 - Reset Default Settings

*1: Two blanking sectors (1 and 2) are available.

*2: When [Enable Sector Blanking] 1 or 2 is ON.

*3: Not available with DRS4L+.

*4: When [Auto Tuning] is OFF.

*5: Available when radar is in stand-by.

*6: DRS4D/6A/12A/25A-NXT only.

- ①
- Targets
 - Display Target IDs (OFF, **ON**)
 - Ignore AIS Targets Slower than... (**1 kn**)
 - Target Icon Size (50, **100**, 200)
 - Ais Message Notification (OFF, **ON**)
 - CPA/TCPA Alarm (**OFF**, ON) * Changes with [Units]→[Long Range] setting.
 - CPA Alarm Value (0.01~99.99; **0.5 NM**) - nm: 0.001~5.000
 - TCPA Alarm Value (0.01~59; **10°**) - km: 0.001~9.000
 - CPA Graphic Display (OFF, **ON**) - mile: 0.001~6.000
 - Proximity AIS Target Alarm (**OFF**, ON)
 - Proximity AIS Target Alarm Value (0.00~5.000*; **100m**)
 - Buddies List (AIS & DSC) (Open the buddies list.)
 - Reset Default Settings
- Fish Finder
 - Fish Finder Source (**TZTxxF**, network sounder name if connected)
 - Day Background Color (**White**, Light Blue, Black, Dark Blue, Blue)
 - Night Background Color (Black, **Dark Blue**, Blue)
 - Echo Color Levels (8 Colors, 16 Colors, **64 Colors**)
 - Color Erase (0 - 50, **0**)
 - Show Range Slider (OFF, **ON**)
 - A-Scope Peak Hold (**OFF**, ON)
 - Cancel Smoothing (**OFF**, ON)
 - Split Range (**OFF**, ON)
 - Bottom Search Mode (OFF, **ON**)
 - Picture Advance (4/1, 2/1, **1/1**, 1/2, 1/4, 1/8, 1/16, Stop)
 - Bottom Range Shift Area (15 - 85(%), **75**)
 - Zoom Range Span (2 - 120(m), **10**)
 - Bottom Lock Range Span (2 - 120(m), **10**)
 - Marker Zoom Shift (0.0 - 3,000(m), **10**)
 - ACCU-FISH Info (Depth, **Fish Size**)
 - ACCU-FISH Symbols (Off, **Solid**, Striped)
 - ACCU-FISH Minimum Size (00.00 - 79.98(in); **00.00**)
 - ACCU-FISH Size Correction (-80 - 100(%), **0**)
 - Heaving Correction (OFF, **ON**; external sounder only)
 - Interference Rejection (Off, Low, Medium, High, **Auto**)
 - Clutter (0 - 100(%), **0**)
 - TVG (or TVG HF, TVG MF, TVG LF)^{*1} *1: BBDS1, DFF1, DFF1-UHD,
 - Transmit Rate Mode (Auto, **Manual**) DFF3: 5=default setting
 - Transmit Rate Manual (0~20, **20**)
 - Fish Finder Transmit (OFF, **ON**)
 - Fish Alarm (**OFF**, ON)
 - Range Minimum Value (0 - 120(m), **0.0**)^{*2}
 - Range Maximum Value (0 - 120(m), **0.9**)^{*2} *2: Range for internal sounder. Range is different for network sounders.
 - Fish Alarm for Bottom Lock (**OFF**, ON)
 - Range Minimum Value (0 - 120(m), **0.0**)^{*2}
 - Range Maximum Value (0 - 120(m), **0.9**)^{*2}
 - Fish Alarm Level (Low, **Medium**, High)
 - Zero Line Rejection (**ON**, OFF)
 - Zero Line Range (1.4 - 2.5; **2.0**)^{*3, *4, *5} *3: DFF3
 - Transducer Draft (0.0 - 99.9(m), **0.0**) *4: DI-FFAMP
 - Salt Water (OFF, **ON**) *5: DI-FFAMP: 1-4 - 3.8; **2.0**

①

② Continued on following page

①

② *Continued from previous page*

- Fish Finder Source (**TZTxxF**, network sounder name if connected)
- Preset Frequency Setup (preset frequency 1, 2, 3)
- Transducer Setup (Open the dialog box for transducer setting.)
- Transmission Format (**Parallel**, Sequential)^{*1}
- Transmission Power Mode (Manual, Auto)^{*1} (Not used)
- Transmission Power (Min, Max)^{*2}
- External KP (**OFF**, ON)
- Bottom Level (HF, MF, LF) (-40 - +40, **0**)
- Gain Offset (HF, MF, LF) (-50 - +50, **0**)
- Auto Gain Offset (HF, MF, LF) (-5 - +5, **0**)^{*3}
- *9 { — STC (HF, MF, LF) (0 - 10)^{*4}
- Frequency Adjust (HF, MF, LF) (-50 - +50)^{*5}
- TX Pulse (HF, MF, LF) (Short 1, Short 2, **Standard**, Long)^{*5, *6}
- RX Band (HF, MF, LF) (Narrow, **Standard**, Wide)^{*5}
- Temperature Port (**MJ Port**, Low Frequency, High Frequency)^{*7}
- Fish Finder Demo Mode (**OFF**, Demo 1 - 4)^{*8}
- Set Hardware to Factory Default
- Reset Default Settings

*1: DI-FFAMP

*2: DI-FFAMP: 0 - 10, **10**
DFF1-UHD: OFF, Min, **Auto**

*3: Auto mode only

*4: DFF3, DFF1-UHD, DI-FFAMP

*5: DFF3

*6: DI-FFAMP w/narrow band width transducer only

*7: DFF3, DFF1-UHD

*8: Internal sounder, DI-FFAMP, BBDS1, DFF1, DFF3,
DFF1-UHD: **OFF**, Shallow, Deep

*9: Menu changes according to transducer.

①

Continued on following page

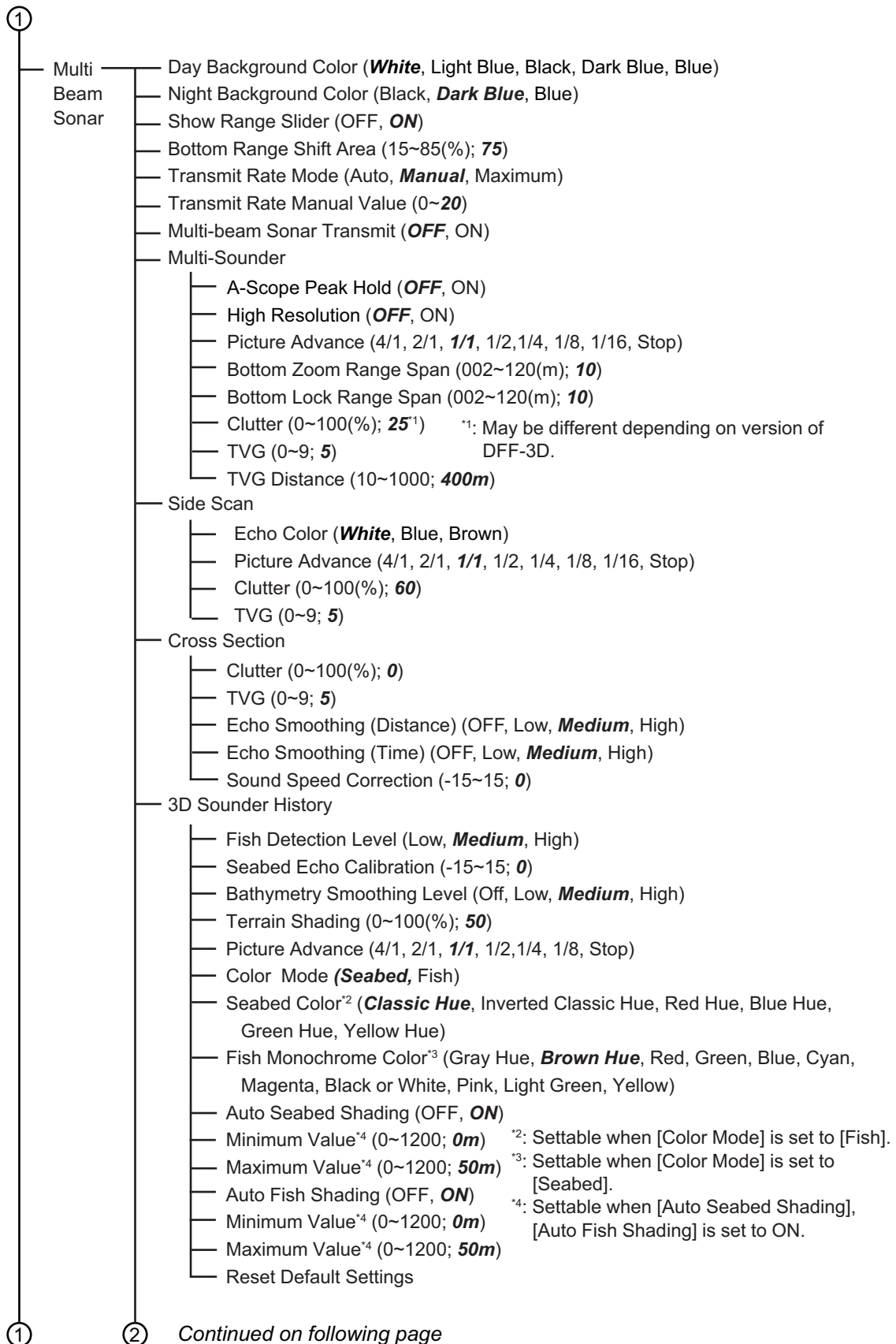

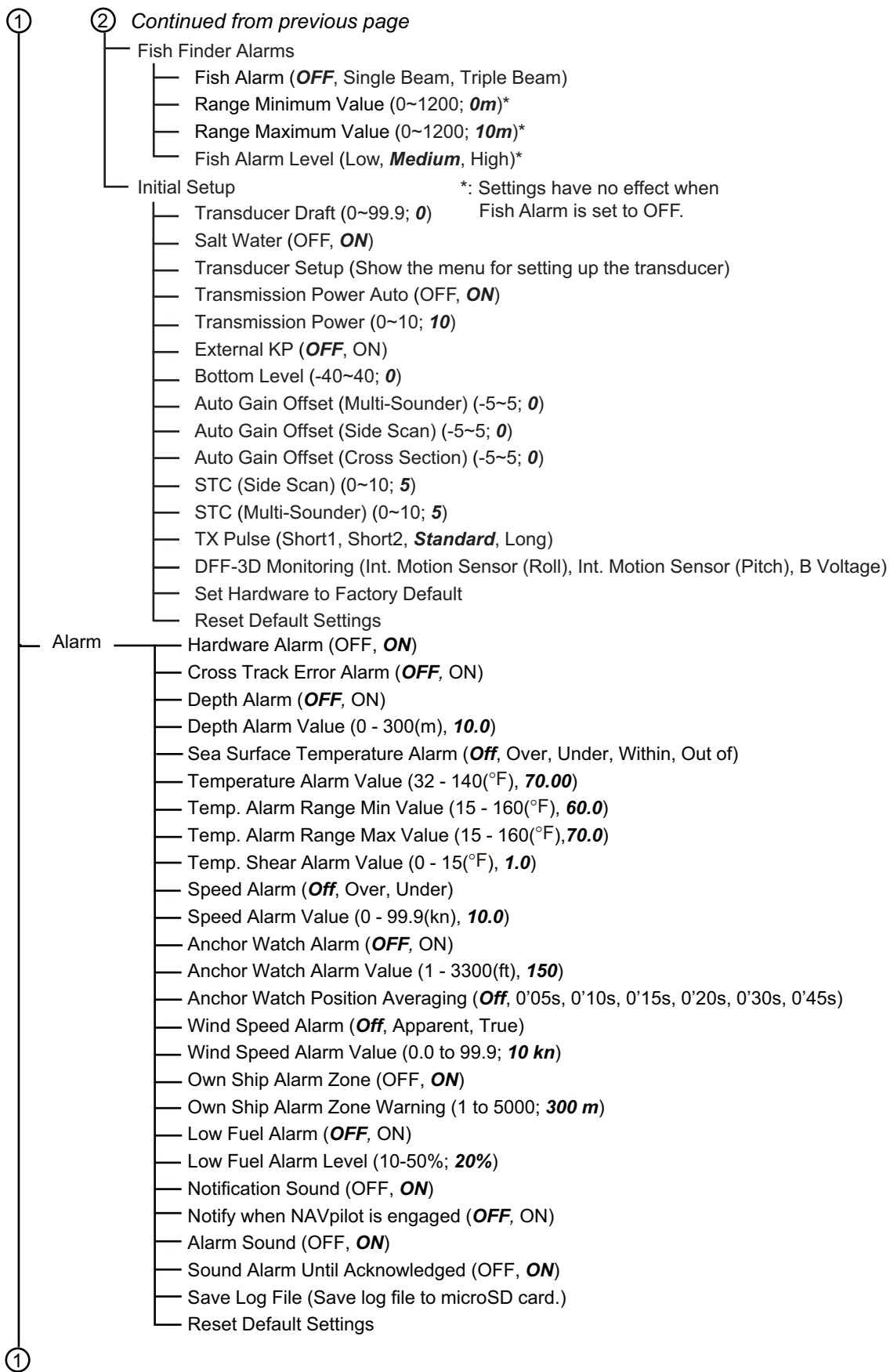

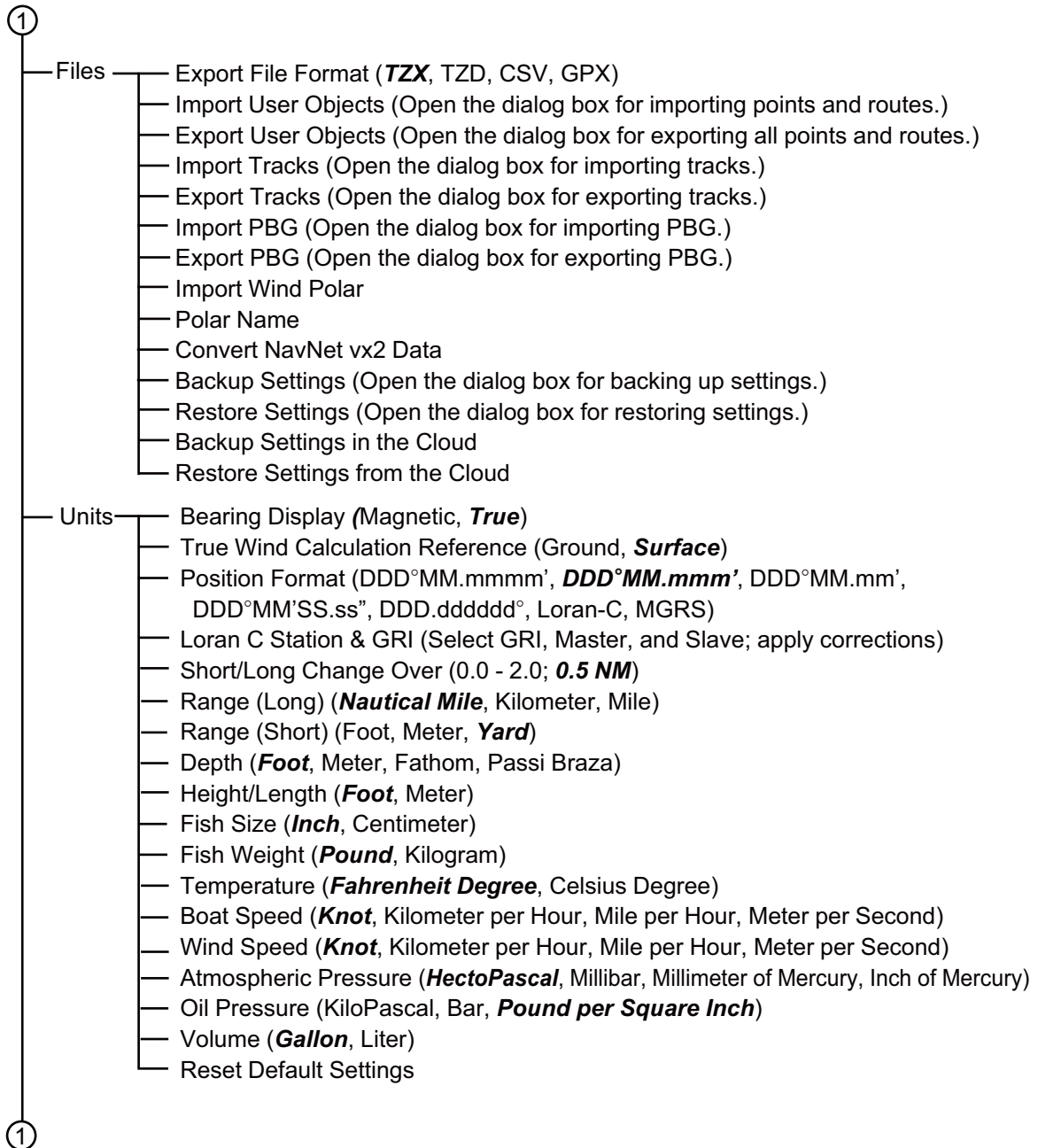

APPENDIX 1 MENU TREE

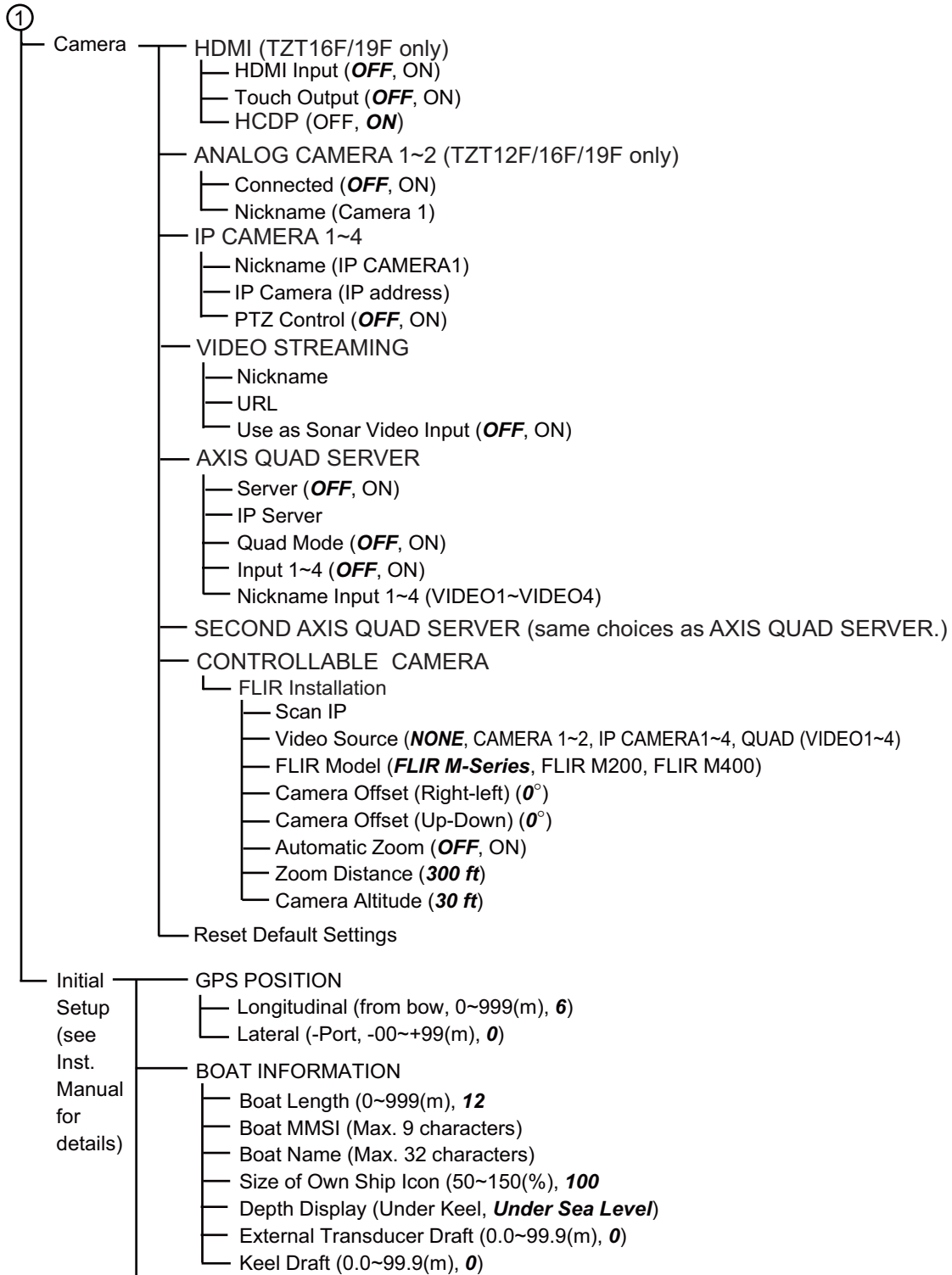

② Continued on following page

② Continued from previous page

- INSTRUMENTS SETUP
 - Engine & Tank Automatic Setup
 - Engine & Tank Manual Setup
 - Graphic Instruments Setup
 - Maximum Boat Speed
 - Maximum Wind Speed
 - DEPTH
 - Minimum Depth
 - Maximum Depth
 - SEA SURFACE TEMPERATURE
 - Minimum Sea Surface Temperature
 - Maximum Sea Surface Temperature
 - PROPULSION ENGINE
 - Max. RPM
 - Red Zone Oil Pressure
 - Max. Oil Pressure
 - Min. Temperature
 - Red Zone Temperature
 - OTHER ENGINE (same options as PROPULSION ENGINE)
 - CZONE SETUP
 - Add Default CZone Pages
 - CZone DIP Switch Settings
 - Reset Instrument Pages
 - Reset Default Settings

- HOME PAGE
 - Factory Reset

- MANUAL FUEL MANAGEMENT
 - Total Fuel Capacity (0,000 - 9,999 (gallons))
 - Manual Fuel Management (**OFF**, ON)

- YAMAHA ENGINE SETUP
 - Trip & Maintenance (Reset trip fuel and distance, and trip and maintenance hours.)
 - Trim Level Calibration (Set trim to "0" (zero).
 - Fuel Flow Level Calibration (-7 to +7(%); **0**)
 - Engine Interface Software Ver. & ID)
 - Reset Engine Interface
 - Reset Engine Instance
 - Reset Number of Engines
 - Trouble Codes

- SUZUKI ENGINE SETUP
 - Diagnosis
 - Create New QR Code
 - View QR Code Logs
 - Engine Interface Software Ver. & ID)
 - Reset Data...
 - Installation...

- IF-NMEAUI SETUP
 - Select IF
 - Category
 - Resistance Full
 - Resistance Mid
 - Resistance Empty
 - Capacity
 - Fluid Instance
 - Self Test
 - Set Hardware to Factory Default

② Continued on following page

② Continued from previous page

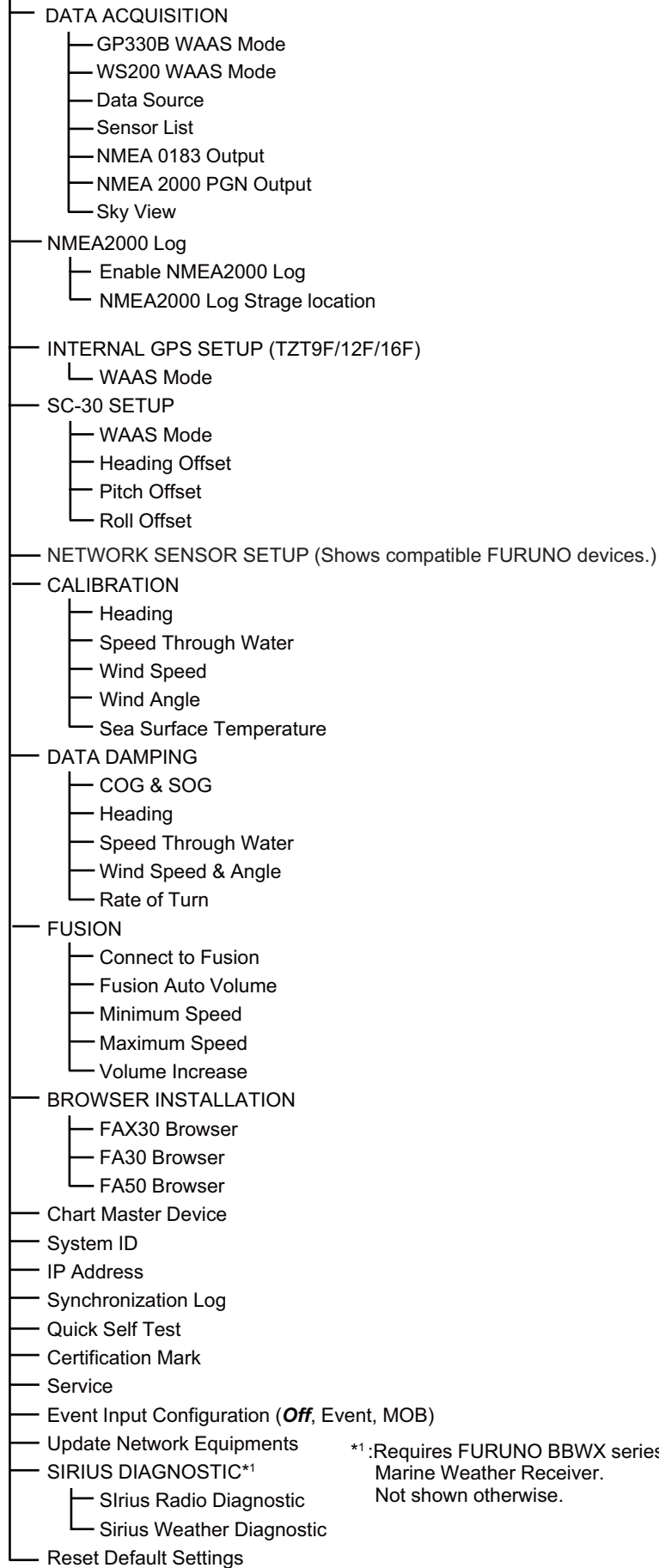

*1: Requires FURUNO BBWX series Marine Weather Receiver. Not shown otherwise.

APPENDIX 2 TRANSDUCER LIST

The table below shows whether the transducers that can be connected to this unit are compatible with ACCU-FISH™, Bottom Discrimination and RezBoost™ functions.

Optional transducers

Standard transducers (CW)

Model	ACCU-FISH™	Bottom Discrimination	RezBoost™	Remarks
520-5PSD	Yes	Yes	Yes	600 W
520-5MSD	Yes	Yes	Yes	
525-5PWD	Yes	Yes	Yes	
525STID-MSD	Yes	Yes	Yes	
525STID-PWD	Yes	Yes	Yes	
520-PLD	Yes	Yes	Yes	
525T-BSD	Yes	Yes	Yes	
525T-PWD	Yes	Yes	Yes	
525T-LTD/12	Yes	Yes	Yes	
525T-LTD/20	Yes	Yes	Yes	
SS60-SLTD/12	Yes	Yes	Yes	
SS60-SLTD/20	Yes	Yes	Yes	
526TID-HDD	Yes	Yes	Yes	
50/200-1T	Yes	Yes	Yes	
50B-6	No	No	No	
50B-6B	No	No	No	
200B-5S	No	No	No	
28BL-6HR	No	No	No	2 kW (Requires DI-FFAMP)
38BL-9HR	No	No	No	
50BL-12HR	No	No	No	
82B-35R	No	No	No	
88B-10	No	No	No	
200B-8	No	No	No	
200B-8B	No	No	No	
28BL-12HR	No	No	No	3 kW (Requires DI-FFAMP)
38BL-15HR	No	No	No	
50BL-24HR	No	No	No	
68F-30H	No	No	No	
100B-10R	No	No	No	
150B-12H	No	No	No	
88F-126H	No	No	No	
200B-12H	No	No	No	
28F-38M	No	No	No	5 kW* (Requires DI-FFAMP and BT-5-1/2)
50F-38	No	No	No	
28F-72	No	No	No	10 kW* (Requires DI-FFAMP and BT-5-1/2)
50F-70	No	No	No	

*: 3 kW with DI-FFAMP

CHIRP transducers

Model	ACCU-FISH™	Bottom Discrimination	RezBoost™	Remarks
TM150M	No	No	No	300 W
B-75L	No	No	No	
B-75H	No	No	No	600 W
B-175H	No	No	No	1 kW
B-175L	No	No	No	
B265LH-FJ12*	Yes	No	No	
CM265LH-FJ12*	Yes	No	No	
TM265LH-FJ12*	Yes	No	No	
PM111LHG	No	No	No	2 kW (Requires DI-FFAMP)
CM599LHG	No	No	No	2 to 3 kW (Requires DI-FFAMP)
CM599LM	No	No	No	

* Not available with the TZT9F.

Other compatible transducersCHIRP transducers (single frequency)

Model	ACCU-FISH™	Bottom Discrimination	RezBoost™	Remarks
B150M	No	No	No	300 W
SS75L	No	No	No	
B75M	No	No	No	600 W
B785M	No	No	No	
SS75H	No	No	No	
SS75M	No	No	No	
B175HW	No	No	No	
B175M	No	No	No	1 kW
B285HW	No	No	No	
B285M	No	No	No	
TM185HW	No	No	No	
TM185M	No	No	No	

CHIRP transducers (dual frequency, not available with the TZT9F)

Model	ACCU-FISH™	Bottom Discrimination	RezBoost™	Remarks
B265LH	Yes	No	No	1 kW
B275LHW	No	No	No	
B265LM	No	No	No	
CM265LH	Yes	No	No	
CM265LM	No	No	No	
CM275LHW	No	No	No	
TM265LH	Yes	No	No	
TM265LM	No	No	No	
TM275LHW	No	No	No	

CHIRP transducers (dual frequency for DI-FFAMP)

Model	ACCU-FISH™	Bottom Discrimination	RezBoost™	Remarks
PM111LH	No	No	No	2 kW
PM111LHW	No	No	No	
R109LH	No	No	No	
R109LHW	No	No	No	
R111LH	No	No	No	
CM599LH	No	No	No	2 to 3 kW
CM599LHW	No	No	No	
R509LH	No	No	No	
R509LHW	No	No	No	
R509LM	No	No	No	
R599LH	No	No	No	
R599LM	No	No	No	

APPENDIX 3 ALERT MESSAGES

The table below shows the alert messages that may appear.

Text	Meaning	Remedy
Hardware: Fan Speed Alarm	The rotation speed of the fan is 4,000 rpm or less.	Do the quick self test. Replace the fan if the rotation speed (IntFan (SYSFAN) Speed)* is 3,999 rpm or less. If the rotation speed is 0 rpm, the connector may be disconnected. Check the connector. *: The TZT19F has two fans. Replace a fan if the rotation speed (ExtFan (FAN2) Speed)* is 3,447 rpm or less.
Several Chart Master Detected	Two or more TZT units are set for the chart master.	Set the chart master on only one TZT unit. Home screen → [Settings] → [Initial Setup] → [Chart Master Device]
No Chart Master Detected	TZT are set for the chart master.	Set the chart master on only one TZT unit. Home screen → [Settings] → [Initial Setup] → [Chart Master Device]
SID not found **	SID is not found. ** is the system ID.	Start TZT with the chart master set to ON.
Object Limit Reached	The user object data has reached the upper limit.	Delete unnecessary user objects to make room. Check the number of used user objects. Home screen → [Settings] → [General] → [DATA USAGE]
AIS Count 100%	AIS data containing 1,000 or more targets is received.	This message disappears when the number of AIS targets becomes less than or equal to 999.
AIS Count 95%	AIS data containing 950 or more targets is received.	This message disappears when the number of AIS targets becomes less than or equal to 949.
AIS SART Alarm	AIS data (including AIS SART) is valid.	This message disappears when AIS data (including AIS SART) is lost. You cannot delete this message manually because this is an emergency warning.
Proximity AIS Target Alarm	If [Proximity AIS Target Alarm] is set to ON, this message appears when an AIS target is within the distance set.	Take evasive action immediately. To cancel the proximity AIS target alarm, use the following procedure. Home screen → [Settings] → [Targets] → [Proximity AIS Target Alarm]
CPA/TCPA Alarm	If [CPA/TPA Alarm] is set to ON, this message appears when a AIS target's CPA and TCPA are less than the threshold value. The status of the AIS target changes to "dangerous target".	Take evasive action immediately. Tap "CPA/TCPA Alarm" on the status bar at the top of the screen to silence the audio alarm and erase the message. To cancel the CPA/TPA alarm, turn off the alarm using the following procedure. Home screen → [Settings] → [Targets] → [CPA/TPA Alarm]
AIS: New Text Message	An AIS safety message is received.	Tap [Delete Message] to clear the message.

Text	Meaning	Remedy
DSC Distress Call	A distress warning is received.	You cannot delete this message manually because this is an emergency warning.
DSC Position Report Received	A non-distress DSC message is received.	This message is erased when a non-distress DSC message is lost.
Radar Connection Lost	Connection with the selected radar sensor is lost.	Reconnect the radar sensor.
Radar Trigger Alarm	Trigger signal error.	Check the radar antenna. Check the connection with the radar antenna.
Radar Video Alarm	Video signal error.	Check the radar antenna. Check the connection with the radar antenna.
Radar Azimuth Alarm	Bearing pulse signal error.	Check the radar antenna. Check the connection with the radar antenna.
Radar Headline Alarm	Heading pulse signal error.	Check the reed switch and magnetron of the radar antenna. Check the connection with the radar antenna.
TARGET ALARM	A target has entered the guard zone.	Take evasive action immediately. Tap the guard zone to cancel the alarm.
Antenna FAN RPM is Low	Problem with the fan of the radar sensor.	Check the fan of the radar sensor.
Bird Mode Activated	The bird mode is turned on.	–
Bird Mode Deactivated	The bird mode is turned off.	–
Target Analyzer Requires 24NM Range or Less	The radar sensor is DRS6A-NXT and the target analyzer is set to 24 NM.	Set the target analyzer within the configurable range (within 16 NM).
Cannot intercept target at current speed	The target cannot be intercepted at the current ship speed.	Raise the ship speed.
Fish Finder Connection Lost	Connection with the selected fish finder is lost.	–
Fish detected - Bottom	A fish school is detected within the range set for the bottom lock fish alarm.	–
Multibeam Sonar Disconnection Alarm	Connection with the multibeam sonar is lost.	Check the connection with the multibeam sonar.
Multibeam Sonar B Voltage Abnormal	The B voltage of the multibeam sonar is outside the specified value (32.4 to 39.6 V).	Have a qualified technician check the connection between the PWRTRX board and the DIGI board of the multibeam sonar. If there is no problem with the connection and no echo is produced, the PWRTRX board is faulty. Contact your dealer for advice.
Multibeam SONAR Fish Detected	A school of fish is detected within the range set for the fish alarm of the multibeam sonar.	–
Sirius Disconnection Alarm	Connection with the SiriusXM receiver is lost.	Check the connection with the SiriusXM receiver.
Weather Update in Progress	The latest weather data is being downloaded from the internet.	This message disappears after the weather data is obtained.

APPENDIX 3 ALERT MESSAGES

Text	Meaning	Remedy
Opening Grib File	The GRIB file (weather information) stored in the TZT is being opened.	–
NAVpilot Connection Lost	Connection with the NAVpilot is lost.	Check the connection with the NAVpilot. Check that power is supplied to the NAVpilot.
NAVpilot Engaged	AUTO/NAV/WIND/TURN/FISH HUNTER/SABIKI is being performed from STBY on the NAVpilot or the TZT.	–
NAVpilot Disengaged	Navigation by the NAVpilot is canceled.	–
Safe Helm Activated	The safe helm function is activated. (The NAVpilot steering mode is temporarily switched to the manual mode.)	
Safe Helm Deactivated	The safe helm function is deactivated.	
Position Lost	No positioning data.	Check for objects which may be blocking reception. Check the connection between the built-in GPS antenna/external GPS and the MAIN board.
Heading Lost	No heading data.	Check the connection with the heading sensor. Check the heading sensor.
Depth Alarm	The depth is lower than the value set for the depth alarm.	Take immediate evasive action to prevent grounding.
Sea Surface Temperature Alarm	The sea surface temperature matches the value set for the sea surface temperature alarm.	–
SST Shear detected	Shear is detected.	–
Speed Alarm	The ship speed matches the value set for the ship speed alarm.	–
Max Wind Speed Exceeded	The wind speed matches the value set for the wind speed alarm.	–
Low Fuel Alarm	The fuel level is lower than or equal to the value (%) set for the low fuel alarm.	Refill the fuel.
MOB	A MOB mark is input.	–
XTE Alarm	This alarm alerts you to course deviation.	The notification will disappear when the set course is recovered.
Anchor Watch Alarm	Your ship has moved a distance greater than the value set for the anchor watch alarm.	The notification will disappear when the ship returns within the specified distance.
Waypoint Crossing Notification	Your ship arrived at the destination.	–
End of Route Notification	Your ship has arrived at the final destination.	–

Text	Meaning	Remedy
Fuel Active Route	The fuel is expected to run out during the route navigation.	Refill the fuel.
NMEA 2000 Logging	NMEA2000 log is being recorded.	–
Boundary Line Crossed	Your ship has crossed a boundary line.	–
In Alarm Zone	Your ship has entered a boundary line.	–
Near Alarm Zone	Your ship is near a boundary line.	–
Check Engine!	Engine error.	Refer to the operator's manual for the engine and contact the engine manufacturer.
Over Temperature!	Engine error (overheat).	Refer to the operator's manual for the engine and contact the engine manufacturer.
Low Oil Pressure!	Engine error (oil pressure drop).	Refer to the operator's manual for the engine and contact the engine manufacturer.
Low Oil Level!	Engine error (oil level drop).	Refer to the operator's manual for the engine and contact the engine manufacturer.
Low Fuel Pressure!	Engine error (fuel pressure drop).	Refer to the operator's manual for the engine and contact the engine manufacturer.
Low System Voltage!	Engine error (voltage drop).	Refer to the operator's manual for the engine and contact the engine manufacturer.
Low Coolant Level!	Engine error (coolant level drop).	Refer to the operator's manual for the engine and contact the engine manufacturer.
Water Flow!	Engine error (water flow).	Refer to the operator's manual for the engine and contact the engine manufacturer.
Water in Fuel!	Engine error (mixture of water in fuel).	Refer to the operator's manual for the engine and contact the engine manufacturer.
Charge Indicator!	Engine indicator error.	Refer to the operator's manual for the engine and contact the engine manufacturer.
Preheat Indicator	Engine indicator error.	Refer to the operator's manual for the engine and contact the engine manufacturer.
High Boost Pressure!	The discharge pressure of the engine pump is too high.	Refer to the operator's manual for the engine and contact the engine manufacturer.
Rev Limit Exceeded!	The engine rotation speed has exceeded the upper limit.	Refer to the operator's manual for the engine and contact the engine manufacturer.
EGR System!	EGR system (engine) error.	Refer to the operator's manual for the engine and contact the engine manufacturer.

APPENDIX 3 ALERT MESSAGES

Text	Meaning	Remedy
Throttle Position Sensor!	Throttle opening sensor (engine) error.	Refer to the operator's manual for the engine and contact the engine manufacturer.
Engine Emergency Stop Mode!	Engine indicator (emergency stop mode) error.	Refer to the operator's manual for the engine and contact the engine manufacturer.
Warning Level 1!	Engine error (Warning Level 1).	Refer to the operator's manual for the engine and contact the engine manufacturer.
Warning Level 2!	Engine error (Warning Level 2).	Refer to the operator's manual for the engine and contact the engine manufacturer.
Power Reduction!	Engine error (power drop).	Refer to the operator's manual for the engine and contact the engine manufacturer.
Maintenance Needed!	Engine error (maintenance required).	Refer to the operator's manual for the engine and contact the engine manufacturer.
Engine Comm Error!	Engine error (undetectable condition).	Refer to the operator's manual for the engine and contact the engine manufacturer.
Sub or Secondary Throttle!	Engine sub-throttle error.	Refer to the operator's manual for the engine and contact the engine manufacturer.
Neutral Start Protect!	Engine error (Neutral Start Protect!).	Refer to the operator's manual for the engine and contact the engine manufacturer.
Engine Shutting Down!	Engine error (stop).	Refer to the operator's manual for the engine and contact the engine manufacturer.
** -Device Missing- **	CZone devices can not be found. ** indicates the source Module Type/Name.	Check the connection with CZone devices.
** -High Temperature Alarm- **	An error is received from the CZone devices.	Refer to the operator's manual for CZone.
** -Very High Temperature Alarm- **	An error is received from the CZone devices.	Refer to the operator's manual for CZone.
** -Low Temperature Alarm- **	An error is received from the CZone devices.	Refer to the operator's manual for CZone.
** -Very Low Temperature Alarm- **	An error is received from the CZone devices.	Refer to the operator's manual for CZone.
** -High Level Alarm- **	An error is received from the CZone devices.	Refer to the operator's manual for CZone.
** -Very High Level Alarm- **	An error is received from the CZone devices.	Refer to the operator's manual for CZone.
** -Low Level Alarm- **	An error is received from the CZone devices.	Refer to the operator's manual for CZone.
** -Very Low Level Alarm- **	An error is received from the CZone devices.	Refer to the operator's manual for CZone.
** -High Battery Capacity Alarm- **	An error is received from the CZone devices.	Refer to the operator's manual for CZone.

Text	Meaning	Remedy
** -Low Battery Capacity Alarm- **	An error is received from the CZone devices.	Refer to the operator's manual for CZone.
** -High Battery Voltage Alarm- **	An error is received from the CZone devices.	Refer to the operator's manual for CZone.
** -Low Battery Voltage Alarm- **	An error is received from the CZone devices.	Refer to the operator's manual for CZone.
** -Very Low Battery Voltage Alarm- **	An error is received from the CZone devices.	Refer to the operator's manual for CZone.
You are logged as **	The data (setting data, points, routes, and tracks) saving on the cloud has been started using the My time zero cloud data service. The User name is displayed in **.	–
Manual Demo	The manual demo mode is enabled.	–
Demo Mode	The demo mode is enabled started with the selected demo file.	–
Previous SID Disable	The previously detected chart master has been disabled.	–
Scanning Drive	The microSD charts are being loaded.	–

APPENDIX 4 RADIO REGULATORY INFORMATION

Wireless Interoperability

This product is designed to be interoperable with any wireless LAN product that is based on direct sequence spread spectrum (DSSS) and orthogonal frequency division multiplexing (OFDM) radio technology and to comply with the following standards.

- IEEE Std 802.11b Standard on 2.4 GHz Wireless LAN
- IEEE Std 802.11g Standard on 2.4 GHz Wireless LAN
- IEEE Std 802.11n Standard on 2.4 GHz Wireless LAN

Safety

This product, like other radio devices, emits radio frequency electromagnetic energy. The level of energy emitted by this device, however, is less than the electromagnetic energy emitted by other wireless devices such as mobile phones. This product operates within the guidelines found in radio frequency safety standards and recommendations. These standards and recommendations reflect the consensus of the scientific community and result from deliberations of panels and committees of scientists who continually review and interpret the extensive research literature. In some situations or environments, the use of this product may be restricted by the proprietor of the building or responsible representatives of the applicable organization. Examples of such situations include the following:

- Using this product onboard airplanes, or
- Using this product in any other environment where the risk of interference with other devices or services is perceived or identified as being harmful.

If uncertain of the policy that applies to the use of wireless devices in a specific organization or environment (an airplane, for example), ask for authorization to use this product before turning it on.

Export Regulation

Radio wave certification is necessary at the export destination. The Wireless LAN of this product operates in the 2.4 GHz band, which does not require a license in most countries. However, the conditions for use of the wireless LAN depend on the country or the area.

USA-Federal Communications Commission (FCC)

This device complies with part 15 of the FCC Rules. Operation is subject to the following two conditions:

- (1) This device may not cause harmful interference, and
- (2) This device must accept any interference received, including interference that may cause undesired operation. Any changes or modifications not expressly approved by the party responsible for compliance could void the user's authority to operate the equipment.

Caution: Exposure to Radio Frequency Radiation

- This equipment complies with FCC radiation exposure limits set forth for an uncontrolled environment and meets the FCC radio frequency (RF) Exposure Guidelines in Supplement C to OET65.
- This equipment should be installed and operated keeping the radiator at least 20 cm or more away from person's body.
- This device must not be co-located or operating in conjunction with any other antenna or transmitter.

Innovation, Science and Economic Development Canada (ISED)

This device contains licence-exempt transmitter(s)/receiver(s) that comply with Innovation, Science and Economic Development Canada's licence-exempt RSS(s). Operation is subject to the following two conditions:

- (1) This device may not cause interference.
- (2) This device must accept any interference, including interference that may cause undesired operation of the device.

Cet appareil contient un ou plusieurs émetteurs / récepteurs exempts de licence qui sont conformes à la norme « exempts de licence RSS (s) » Canadienne d'Innovation, Sciences et Développement économique. L'exploitation est autorisée aux deux conditions suivantes:

- (1) l'appareil ne doit pas produire de brouillage.
- (2) l'utilisateur de l'appareil doit accepter tout brouillage radioélectrique subi, même si le brouillage est susceptible d'en compromettre le fonctionnement.

Caution: Exposure to Radio Frequency Radiation

This equipment complies with ISED radiation exposure limits set forth for an uncontrolled environment and meets RSS-102 of the ISED radio frequency (RF) Exposure rules. This equipment should be installed and operated keeping the radiator at least 20 cm or more away from person's body.

Cet équipement est conforme aux limites d'exposition aux rayonnements énoncées pour un environnement non contrôlé et respecte les règles d'exposition aux fréquences radioélectriques (RF) CNR-102 de l'ISED. Cet équipement doit être installé et utilisé en gardant une distance de 20 cm ou plus entre le dispositif rayonnant et le corps.

To reduce potential radio interference to other users, the antenna type and its gain should be so chosen that the equivalent isotropically radiated power (EIRP) is not more than that required for successful communication.

**SPECIFICATIONS OF MULTI FUNCTION DISPLAY
TZT12F/16F/19F**

1 DISPLAY FUNCTION

- 1.1 Screen
 - TZT9F 9-inch touch-panel color display, 1280 x 720 (HD)
 - TZT12F 12.1-inch touch-panel color display, 1280 x 800 (WXGA)
 - TZT16F 15.6-inch touch-panel color display, 1920 x 1080 (FHD)
 - TZT19F 18.5-inch touch-panel color display, 1920 x 1080 (FHD)
- 1.2 Brightness
 - TZT9F 1000 cd/m² typical
 - TZT12F 900 cd/m² typical
 - TZT16F 1000 cd/m² typical
 - TZT19F 900 cd/m² typical
- 1.3 Display colors 16,770,000 colors (plotter), 64 colors for radar/sounder echo
- 1.4 Language Bulgarian, Chinese, Danish, English (UK/US), Finnish, French, German, Greek, Italian, Japanese, Norwegian, Polish, Portuguese, Russian, Spanish, Swedish, Turkish

2 PLOTTER FUNCTION

- 2.1 Display mode Course plot, NAV data (includes instrument and engine data)
- 2.2 Projection Mercator
- 2.3 Usable area 85° latitude or below
- 2.4 Memory capacity Track: 30,000 points, Point/MOB: 30,000 points
Route: 200 courses w/500 points each
ARPA: 30 targets (100 for DRS-NXT ser.) , AIS: 100 targets
- 2.5 Alarm Anchor watch, XTE, Own ship alarm zone
(TZT19F requires external data)
- 2.6 GPS receiver (TZT9F/12F/16F)
 - Receiving frequency 1575.42 MHz
 - Number of channel GNSS: 72 ch (GPS, SBAS, QZSS)
 - Accuracy GNSS: 10 m (2drms, HDOP<4),
WAAS: 3 m (2drms, HDOP<4), MSAS: 7 m (2drms, HDOP<4)
 - Ship's speed range 500 m/s max. (all satellites at -130dBm)
 - Position fixing time Cold start: 100 s typical
 - Position update interval 0.1 s

3 RADAR FUNCTION

- 3.1 Orientation mode Head-up, North-up (heading data required)
- 3.2 Echo trail 15/30 s, 1/3/6/15/30 min. or continuous
- 3.3 ARPA target 30 point (100 for DRS-NXT ser.)
- 3.4 Alarm Guard-zone, CPA/TCPA, Trigger, Video, Azimuth, Heading line

4 SOUNDER FUNCTION

- 4.1 Frequency CW: 50/200 kHz, CHIRP: 40 to 225 kW
- 4.2 Output power 300/600 W, 1 kW or

- 4.3 Display mode 2 to 3 kW (optional fish finder power amplifier required)
ACCU-FISH™, A-scope, ResBoost™,
Estimation for bottom composition, Temperature graph
- 4.4 Alarm School of fish, School of fish for bottom lock

5 OTHER FUNCTIONS

- 5.1 AIS information AIS receiver required
- 5.2 DSC display 20 target max, Target data required
- 5.3 Instrument indication Instrument data required
- 5.4 Camera monitor NTSC/PAL data required
- 5.5 Information indication FAX/NAVTEX, Weather information (external data required)
- 5.6 Alarm Speed, Wind speed*, Depth*, Water temperature*,
Sea surface temperature*, Low fuel *
*: external data required
(TZT19F requires external data for all items)

6 INTERFACE

- 6.1 Number of port
 - HDMI output (TZT9F excluded)
1 port, TZT12F: 720p (WXGA), TZT16F/19F: 1080p (FHD)
 - HDMI input (TZT16F/19F only)
1 port, 1920 x 1080 (FHD) or less, HDCP, Non-interlaced
 - Video input (composite) 2 ports, NTSC/PAL
 - USB 1 port (TZT9F/12F) or 2 ports (TZT16F/19F), USB2.0,
for touch-monitor and control unit
 - LAN 1 port (TZT9F), 2 ports (TZT12F/16F/19F), Ethernet 100Base-TX
 - NMEA2000 1 port
 - Serial 1 port, NMEA0183 output
 - Contact closure 2 port, event switch and external power switch
 - SD card slot 1 port, micro-SDXC
- 6.2 Wireless LAN IEEE802.11b/g/n
 - Transmit frequency 2.412 to 2.462 GHz
 - Output power 11 dBm max.
- 6.3 NMEA0183 sentences
 - Output AAM, APB, BOD, DBT, DPT, GGA, GLL, GNS, GSA, GSV, RMB,
RMC, RTE, TTM, VDM, VTG, WPL, XTE, ZDA
- 6.4 NMEA2000 PGN

Input	065280, 126992, 126993, 126996, 127237, 127245, 127250, 127251, 127257, 127488, 127489, 127505, 128259, 128267, 129025, 129026, 129029, 129330, 129038, 129039, 129040, 129041, 129291, 129538, 129540, 129793, 129794, 129798, 129801, 129802, 129808, 129809, 129810, 130306, 130310, 130311, 130312, 130313, 130314, 130316, 130577, 130578, 130817, 130818, 130820, 130822, 130823, 130826, 130827, 130828, 130880
Output	126992, 126993, 126996, 127250, 127251, 127257, 127258, 128259, 128267, 128275, 129025, 129026, 129029, 129033, 129283, 129284, 129285, 130306, 130310, 130311, 130312, 130313, 130314, 130316

7 POWER SUPPLY

- 7.1 Multi function display
- | | |
|--------|------------------------------------|
| TZT9F | 12-24 VDC (10.8-31.2 V): 2.6-1.3 A |
| TZT12F | 12-24 VDC (10.8-31.2 V): 2.3-1.2 A |
| TZT16F | 12-24 VDC (10.8-31.2 V): 4.3-2.2 A |
| TZT19F | 12-24 VDC (10.8-31.2 V): 4.7-2.3 A |
- 7.2 Rectifier (option) 100/110/115/220/230 VAC, 1 phase, 50/60 Hz
- 7.3 AC/DC power supply unit (option)
- | | |
|--------|--------------------------------|
| PR-241 | 100-230 VAC, 1 phase, 50-60 Hz |
|--------|--------------------------------|

8 ENVIRONMENTAL CONDITIONS

- 8.1 Ambient temperature -15°C to +55°C
- 8.2 Relative humidity 93% or less at +40°C
- 8.3 Degree of protection IP56
- 8.4 Vibration IEC 60945 Ed.4

9 UNIT COLOR

N1.0 (fixed)

INDEX

Numerics

- 2D/3D switch 3-2
- 3D display
 - activating 3-2
 - description 3-1
 - exaggeration 3-3
- 3D sounder history display
 - bathymetry smoothing 8-14
 - depth indication 8-19
 - echo detection level 8-14
 - example 8-5
 - frequency indication 8-19
 - function availability 8-19
 - marking school of fish 8-14
 - picture advancement 8-14
 - terrain shading 8-15
 - TX and ST-BY 8-13
 - viewpoint position 8-13

A

- ACCU-FISH
 - description 7-16
 - fish size correction 7-17
 - information 7-17
 - setting 7-16
 - showing icon on 3D display 3-12
 - showing/hiding symbol 7-17
- Advanced Wx data 13-8
- AIS
 - buddies list 14-8
 - CPA/TCPA alarm 14-7
 - finding target on chart plotter display 14-6
 - ignoring slow targets 14-3
 - list 14-5
 - locating target on chart plotter display .. 14-6
 - lost target 14-2
 - nickname of target 14-6
 - proximity AIS target alarm 14-3
 - showing/hiding symbols 14-1
 - target data with pop-up menu 14-4
 - target details 14-6
 - target IDs 14-4
 - target symbols 14-1
- AIS list 14-5
- AIS transponder (FA-30, FA-50) setup . 14-10
- Alarm sensitivity (fish finder) 7-15
- Alarms
 - alarm menu 2-12
 - anchor watch 2-15
 - audio alarm silencing 2-12
 - aural alarm on/off 2-17
 - bottom lock fish alarm 7-14
 - CPA/TCPA 6-33, 14-7
 - depth 2-13

- fish 7-14
- proximity AIS target 14-3
- speed 2-15, 2-17
- SST 2-14
- XTE 2-13
- Alarms list 2-18
- Alert messages AP-18
- Anchor watch alarm
 - position averaging 2-16
 - setting 2-15
- Antenna
 - heading alignment 6-36
 - height 6-36
 - main bang suppression 6-36
 - position 6-36
 - rotation start, stop 6-36
 - sector blaning 6-36
- ARPA
 - automatic target acquisition 6-29
 - clearing lost target 6-32
 - CPA/TCPA alarm 6-33
 - manual target acquisition 6-29
 - showing/hiding display 6-28
 - stop tracking target 6-31
 - target data 6-30
- A-scope display 7-5

B

- Background color
 - fish finder 7-22
 - radar 6-21
- Bathymetry smoothing 8-14
- Beam angle (multi-sounder display) 8-6
- Beam type selection (multi-sounder display) 8-6
- Beam width (multi-sounder display) 8-7
- Bird mode 6-23
- Boat icon
 - description 2-4
- Bottom discrimination display 7-6
- Bottom echo calibration 8-14
- Bottom level 7-24
- Bottom lock display 7-4
- Bottom lock fish alarm
 - activating, deactivating 7-15
 - sensitivity 7-15
 - setting 7-14
- Bottom range shift area 7-23
- Bottom zoom display 7-4
- Boundaries
 - adding point to 4-33
 - alarm for 4-34
 - boundaries list 4-28
 - creating 4-25, 4-26

INDEX

- default attributes.....4-27
- deleting.....4-36
- deleting a point, line4-34
- displaying at screen center4-35
- editing..... 4-31, 4-32
- moving a point.....4-33
- points used.....4-35
- searching.....4-29
- showing, hiding4-26
- sorting4-28
- Boundaries list4-28
- Buddies list.....14-8
- C**
- Camera/Video
 - contrast adjustment.....10-7
 - FLIR camera10-3
 - image size10-7
 - showing10-1
 - switching inputs.....10-7
- Catches list4-12
- Chart information2-7
- Chart object info2-6
- Chart plotter menu2-26
- Charts
 - adding15-13
 - deleting.....15-14
 - panning2-3
 - range2-2
 - S52 charts objects.....2-10
 - type2-1
 - updating15-13
 - vector charts text and object
 - information2-9
 - viewing15-12
 - zoom in, zoom out.....2-2
- Clutter (fish finder)7-9
- Color erase7-11
- Controls.....1-1
- CPA graphic display
 - AIS14-9
 - radar.....6-34
- CPA/TCPA alarm 6-33, 14-7
- Cross section display
 - depth indication8-12
 - example.....8-5
 - frequency indication8-12
 - function availability8-12
 - grid8-10
 - speed of sound correction.....8-11
 - TX and ST-BY.....8-10
- CZone
 - CZone control, instrument display.....12-19
 - CZone control, slide-out menu12-20
 - CZone modes, data area12-22
 - CZone modes, instruments display.....12-21
 - CZone modes, slide-out menu12-23
 - CZone monitoring, data area12-25
 - CZone monitoring, instruments display12-24
- DIP switch settings.....12-18
- page addition, edit.....12-18
- D**
- Data area
 - adding data to1-24
 - contents of data box.....1-23
 - data format (analog or digital)1-25
 - deleting data box from.....1-24
 - description1-22
 - order of data.....1-23
 - transparency1-25
- Depth alarm2-13
- Depth measurement.....7-12
- Depth shading overlay
 - description3-4
 - settings.....3-5
- Depth/color shading8-16
- DI-FFAMP7-20
- Display brilliance1-14
- Display icons
 - description1-16
 - editing.....1-18, 1-19
 - removing1-19
- Display selection
 - home screen1-17
 - quick page.....1-17
- DSC list14-12
- DSC message
 - displaying14-11
 - DSC list14-12
 - going to position of.....14-11
 - notification of14-11
- Dual frequency display.....7-3
- Dual range radar6-22
- E**
- EBL
 - bearing measurement with.....6-11
 - range measurement with.....6-12
 - reference6-12
- Echo average (radar)6-15
- Echo color (radar)6-21
- Echo detection level.....8-14
- Echo history7-12
- Echo smoothing
 - distance.....8-11
 - time8-11
- Echo trail (radar)6-18
- Echo trails
 - clearing.....6-18
 - color6-19
 - length6-18
 - reference6-19
 - shading.....6-20
 - showing, hiding6-18
- Edge swipe1-20
- End of route notification5-19

- Event marks
 - default settings 4-8
 - entering a comment 4-6
 - entering on chart plotter display 4-3
 - information 4-6
 - introduction..... 4-1
 - log catch..... 4-4
- Exporting
 - PBG recordings 9-4
 - points..... 9-2
 - routes 9-2
 - track 9-3
- External KP 7-24
- F**
- False echoes
 - fish finder..... 7-29
 - radar 6-37
- Fan replacement 16-3
- FAX-30 (Facsimile Receiver) setup 15-10
- File format 9-1
- Fish alarm
 - activating, deactivating 7-15
 - setting..... 7-14
- Fish finder automatic operation 7-7
- Fish finder menu 7-22
- Fish mapping (SiriusXM)
 - data 13-22
 - features 13-18
 - settings..... 13-22
 - showing display 13-17
- Fish-It
 - operation 2-40
 - showing in pop-up menu 2-40
- Fleet list..... 2-37
- Fleet tracking
 - centering a fleet target 2-39
 - clearing fleet target symbols 2-37
 - fleet list..... 2-37
 - fleet target info 2-36
 - fleet target symbol on/off 2-36
 - setting up..... 2-35
 - sharing user objects 2-39
- FLIR camera
 - controlling..... 10-7
 - setting..... 10-6
- Fuel level indicators 5-24
- Fuel management 12-16
- Function availability
 - 3D sounder history display 8-19
 - cross section display 8-12
 - multi-sounder display 8-8
 - side scan display 8-9
- Fuse replacement 16-2
- FUSION-Link 11-1
- G**
- Gain
 - offset (fish finder) 7-24
 - radar 6-2
- Gain offset (fish finder)..... 7-24
- General menu 15-1
- Grid (cross section display)..... 8-10
- Guard zone
 - activating, deactivating 6-16
 - setting..... 6-15
 - showing/hiding 6-17
- H**
- Heading line
 - Own ship icon (chart plotter) 2-4
 - radar 6-14
- Heaving 7-23
- Heaving correction 7-23
- High resolution (fish finder) 7-22
- Home icon 1-15, 1-33
- Home screen
 - display selection 1-17
 - editing display icons 1-18
 - introduction..... 1-15
- I**
- Importing
 - boundary lines 9-2, 9-5, 13-6
 - PBG recordings..... 9-4
 - points..... 9-2
 - routes 9-2
 - track 9-3
- Initial setup menu 15-5
- Instrument display
 - adding indication 12-14
 - changing position of data 12-11
 - editing indication 12-12
 - showing 12-1
 - switching between displays..... 12-10
 - theme 12-16
- Interference
 - fish finder..... 7-11
 - radar 6-14
- L**
- Language 1-37
- Layers menu 1-21
- Laylines
 - data 5-24
 - enabling, disabling 5-24
 - polar wind file 5-25
- Log catch..... 4-4
- Low fuel alarm 2-17
- M**
- Magnetron replacement 16-2
- Main bang suppression 6-36
- Maintenance..... 16-1
- MCU-002 1-5
- MCU-004 1-6
- MCU-005 1-8
- Menu tree AP-1

INDEX

- MicroSD cards
 - care of 1-28
 - compatible cards 1-29
 - formatting 1-28
 - inserting 1-28
 - removing 1-28
- MOB (Man OverBoard) 1-37
- MOB mark 1-37
- Multiple echoes (radar) 6-37
- Multi-sounder display
 - beam angle 8-6
 - beam type selection 8-6
 - beam width 8-7
 - depth indication 8-7
 - example 8-3
 - frequency indication 8-7
 - function availability 8-8
 - TX and ST-BY 8-6
- My TimeZero
 - creating 1-42
 - logging in to account 1-42
- N**
- NavCenter weather
 - data availability 13-10
 - data description 13-10
 - displaying 13-4
 - downloading 13-3
 - file loading 13-6
 - setting 13-2
- NAVpilot
 - data box 2-28
 - enabling use 2-27
 - NAVpilot control box 2-28
 - settings 2-31
 - steering mode 2-29
 - steering to a point 4-23
- O**
- Off center 6-13
- Orientation mode
 - chart plotter 2-3
 - radar 6-5
- Orientation mode switch
 - chart plotter 2-3
 - radar 6-5
- Overlays
 - depth shading 3-4
 - radar 3-6
 - tidal current 3-10
 - tide info 3-8
- Own ship icon (chart plotter)
 - COG vector 2-4
 - heading line 2-4
 - orientation 2-5
- Own ship icon (radar) 6-20
- P**
- PBG recording
 - deleting a part of 8-21
 - deleting all recordings 8-22
 - displaying 8-21
 - exporting 9-4
 - recording 8-20
 - speed filter 8-20
 - speed of sound correction 8-22
- Photos
 - deleting 2-35
 - editing photo information 2-34
 - importing 2-33
 - moving on screen 2-33
 - photo list 2-34
- Picture advance speed 7-10
- PIN code 1-44
- Points
 - default settings 4-7
 - deleting 4-13, 4-14
 - deleting specific points 4-36, 5-12
 - density 4-18
 - editing 4-15, 4-16
 - editing collectively 4-16
 - entering from external equipment 4-3
 - entering on chart plotter display 4-2
 - entering on fish finder display 4-4
 - following with NAVpilot 4-23, 5-20
 - going to on-screen point 4-19
 - goto 4-19, 4-20, 4-22
 - goto point information 4-23
 - importing 9-2
 - information 4-6
 - introduction 4-1
 - manual input 4-2
 - moving 4-13
 - moving to screen center 4-17
 - naming function 4-18
 - points list 4-10
 - points used display 4-9
 - registering from points list 4-3
 - registering points 4-3
 - restarting navigation to 4-24
 - searching 4-10, 4-11
 - showing/hiding point names 4-18
 - sorting 4-10
 - stopping navigation to 4-24
- Points list 4-10
- Pop-up menu 1-21
- Power on/off 1-12
- Power switch 1-1, 1-2, 1-12, 1-14
- Proximity AIS target alarm 14-3
- Q**
- Quick page 1-17, 1-20
- R**
- Racon 6-40
- Radar overlay
 - description 3-6
 - settings 3-7
- Radio regulatory information AP-24

- Rain clutter 6-4
- Range
 - chart plotter 2-2
 - radar 6-5
- Range and bearing measurement
 - chart plotter 2-7
 - radar 6-13
- Range and bearing measurement with cursor (radar) 6-8
- Range measurement
 - chart plotter 2-6
 - fish finder 7-12
- Range rings
 - bearing mode 6-7
 - description 6-6
 - interval 6-7
- Remote control unit
 - group setting 1-10
 - MCU-002 1-5
 - MCU-004 1-6
 - MCU-005 1-8
- Rez boost 6-27
- Route Details window 5-16
- Routes
 - auto zoom at arrival to go to point 5-18
 - color 5-26
 - continuing navigation at end of route 5-19
 - creating 5-2, 5-3
 - creating from points list 5-4
 - creating with current track 2-24
 - creating with past track 2-23
 - cruising speed for planning 5-26
 - deleting 5-11, 5-12
 - deleting all 5-12
 - deleting points, route points 5-5
 - density 5-13, 5-26
 - description 5-1
 - detailed information 5-16
 - editing 5-10
 - end of route notification 5-19
 - exporting 9-2
 - extending 5-5
 - finding on chart 5-11
 - following 5-13, 5-14
 - following in reverse direction 5-17
 - inserting route points 5-4
 - moving route points 5-5
 - restarting navigation 5-16, 5-17
 - route details window 5-16
 - routes list 5-6
 - routes menu 5-26
 - routes used 5-11
 - searching 5-7
 - showing, hiding 5-12
 - showing, hiding active route on radar ... 6-20
 - skipping a route point 5-17
 - starting navigation 5-15
 - steering with NAVpilot 5-20
 - stop following 5-17
 - thickness 5-26
 - waypoint arrival notification 5-19
 - waypoint switching mode 5-18
 - XTE lines 5-18
- Routes list 5-6
- Routes menu 5-26
- RX band (fish finder) 7-25
- S**
- S-52 charts cartographic objects 2-10
- S-52 display menu 2-10
- Safety instructions ii
- SAR 5-21
- SART 6-39
- Satellite photo overlay 3-6
- SD cards
 - loading equipment settings 9-5
 - saving equipment settings 9-4
- Sea clutter 6-4
- Sector blaning (antenna) 6-36
- Sector blanking 6-38
- Sensor icons 1-16
- Settings menu 1-33
- Side scan display
 - depth indication 8-9
 - echo color 8-9
 - example 8-4
 - frequency indication 8-9
 - function availability 8-9
 - TX and ST-BY 8-9
- Sidelobe echoes 6-39
- Single frequency display 7-2
- SiriusXM radio
 - controls 13-15
 - diagnostics 13-16
 - enabling 13-14
- SiriusXM weather
 - advanced Wx data 13-8
 - animation radar 13-8
 - data availability 13-10
 - data description 13-10
 - diagnostics 13-13
 - icons overview 13-9
 - setup 13-7
 - Wx radar 13-8
- Slide-out menu 1-20
- Soft cover 1-2
- Software update 15-11
- Speed alarm 2-15, 2-17
- SST alarm 2-14
- Stand-by (radar) 6-1
- STC (fish finder) 7-24
- System configuration xvii
- T**
- Target analyzer 6-24
- Temperature graph 7-19
- Terrain shading 8-15

INDEX

- Tidal current graph3-11
- Tidal current overlay
 - displaying3-10
 - icon size3-10
- Tide graph3-9
- Tide info overlay
 - displaying3-8
 - tide graph3-9
 - tide icon size3-8
 - tide information display3-8
- Touchscreen operations 1-2
- Track
 - color 2-20, 2-23
 - creating route with current track2-24
 - creating route with past track2-23
 - deleting.....2-25
 - deleting all2-25
 - description.....2-18
 - exporting9-3
 - importing9-3
 - interval.....2-19
 - points used display.....2-25
 - recording2-18
 - showing/hiding2-19
 - thickness2-23
- Track back2-24
- Transducer draft.....7-24
- Transducer setup7-24
- Transmit (radar)6-1
- Troubleshooting
 - chart plotter16-4
 - fish finder.....16-5
 - general16-3
 - radar.....16-4
- Tuning6-1
- TVG.....7-13
- Two-finger tap function 1-36
- TX and ST-BY
 - 3D sounder history display8-13
 - cross section display8-10
 - multi-sounder display8-6
 - radar.....6-1
 - side scan display8-9
- TX pulse (fish finder).....7-25
- TX/Standby switch6-1
- TZ iboat2-32
- U**
 - Units menu15-3
- V**
 - Vector charts text and objects2-9
 - Viewpoint position (3D sounder history display)8-13
- Virtual image6-38
- VRM
 - fish finder.....7-12
 - radar..... 6-9, 6-10
- W**
 - Watchman6-17
 - Waypoint arrival notification5-19
 - Waypoint switching mode5-18
 - Weather display
 - advanced Wx data13-8
 - animation radar13-8
 - introduction.....13-1
 - NavCenter data display13-4
 - NavCenter data download.....13-3
 - NavCenter weather file.....13-6
 - NavCenter weather setup13-2
 - selecting13-1
 - SiriusXM.....13-6
 - Welcome screen1-12
 - Wireless LAN
 - connect to existing1-39
 - creating network.....1-41
- X**
 - XTE alarm2-13
 - XTE lines.....5-18
- Y**
 - Yamaha engine display
 - alarm list.....12-32
 - data box12-30
 - example displays.....12-29
 - showing12-28
 - switching displays12-30
 - troll mode12-31
 - trouble codes.....12-32
- Z**
 - Zero line7-26
 - Zoom display8-11
 - Zoom display selection (fish finder).....7-4
 - Zoom reference lines7-22

Declaration of Conformity

[TZT9F/TZT12F/TZT16F/TZT19F]

- Bulgarian (BG)** С настоящото Furuno Electric Co., Ltd. декларира, че гореспоменат тип радиосъоръжение е в съответствие с Директива 2014/53/ЕС, СИ 2017/1206. Цялостният текст на ЕС/УК декларацията за съответствие може да се намери на следния интернет адрес:
- Spanish (ES)** Por la presente, Furuno Electric Co., Ltd. declara que el tipo de equipo radioeléctrico arriba mencionado es conforme con la Directiva 2014/53/UE, SI 2017/1206. El texto completo de la declaración de conformidad de la EU/UK está disponible en la siguiente dirección Internet:
- Czech (CS)** Tímto Furuno Electric Co., Ltd. prohlašuje, že výše zmíněné typ rádiového zařízení je v souladu se směrnicí 2014/53/EU, SI 2017/1206. Úplné znění EU/SK prohlášení o shodě je k dispozici na této internetové adrese:
- Danish (DA)** Hermed erklærer Furuno Electric Co., Ltd., at ovennævnte radioudstyr er i overensstemmelse med direktiv 2014/53/EU, SI 2017/1206. EU/UK-overensstemmelseserklæringens fulde tekst kan findes på følgende internetadresse:
- German (DE)** Hiermit erklärt die Furuno Electric Co., Ltd., dass der oben genannte Funkanlagentyp der Richtlinie 2014/53/EU, SI 2017/1206 entspricht. Der vollständige Text der EU/UK-Konformitätserklärung ist unter der folgenden Internetadresse verfügbar:
- Estonian (ET)** Käesolevaga deklareerib Furuno Electric Co., Ltd., et ülalmainitud raadioseadme tüüp vastab direktiivi 2014/53/EL, SI 2017/1206 nõuetele. EL/GB vastavusdeklaratsiooni täielik tekst on kättesaadav järgmisel internetiaadressil:
- Greek (EL)** Με την παρούσα η Furuno Electric Co., Ltd., δηλώνει ότι ο προαναφερθέντας ραδιοεξοπλισμός πληροί την οδηγία 2014/53/ΕΕ, SI 2017/1206. Το πλήρες κείμενο της δήλωσης συμμόρφωσης ΕΕ/UK διατίθεται στην ακόλουθη ιστοσελίδα στο διαδίκτυο:
- English (EN)** Hereby, Furuno Electric Co., Ltd. declares that the above-mentioned radio equipment type is in compliance with Directive 2014/53/EU, SI 2017/1206. The full text of the EU/UK declaration of conformity is available at the following internet address:
- French (FR)** Le soussigné, Furuno Electric Co., Ltd., déclare que l'équipement radioélectrique du type mentionné ci-dessus est conforme à la directive 2014/53/UE, SI 2017/1206. Le texte complet de la déclaration UE/RU de conformité est disponible à l'adresse internet suivante:
- Croatian (HR)** Furuno Electric Co., Ltd. ovime izjavljuje da je gore rečeno radijska oprema tipa u skladu s Direktivom 2014/53/EU, SI 2017/1206. Cjeloviti tekst EU/UK izjave o sukladnosti dostupan je na sljedećoj internetskoj adresi:
- Italian (IT)** Il fabbricante, Furuno Electric Co., Ltd., dichiara che il tipo di apparecchiatura radio menzionato sopra è conforme alla direttiva 2014/53/UE, SI 2017/1206. Il testo completo della dichiarazione di conformità UE/RU è disponibile al seguente indirizzo Internet:
- Latvian (LV)** Ar šo Furuno Electric Co., Ltd. deklarē, ka augstāk minēts radioiekārta atbilst Direktīvai 2014/53/ES, SI 2017/1206. Pilns ES/AK atbilstības deklarācijas teksts ir pieejams šādā interneta vietnē:

- Lithuanian (LT) Aš, Furuno Electric Co., Ltd., patvirtinu, kad pirmiau minėta radijo įrenginių tipas atitinka Direktyvą 2014/53/ES, SI 2017/1206.
Visas ES/JK atitikties deklaracijos tekstas prieinamas šiuo interneto adresu:
- Hungarian (HU) Furuno Electric Co., Ltd. igazolja, hogy fent említett típusú rádióberendezés megfelel a 2014/53/EU, SI 2017/1206 irányelvnek.
Az EU/EK-megfelelőségi nyilatkozat teljes szövege elérhető a következő internetes címen:
- Maltese (MT) B'dan, Furuno Electric Co., Ltd., niddikjara li msemmija hawn fuq-tip ta' taghmir tar-radju huwa konformi mad-Direttiva 2014/53/UE, SI 2017/1206.
It-test kollu tad-dikjarazzjoni ta' konformità tal-UE/RU huwa disponibbli f'dan l-indirizz tal-Internet li ġej:
- Dutch (NL) Hierbij verklaar ik, Furuno Electric Co., Ltd., dat het hierboven genoemde type radioapparaat conform is met Richtlijn 2014/53/EU, SI 2017/1206.
De volledige tekst van de EU/VK-conformiteitsverklaring kan worden geraadpleegd op het volgende internetadres:
- Polish (PL) Furuno Electric Co., Ltd. niniejszym oświadcza, że wyżej wymieniony typ urządzenia radiowego jest zgodny z dyrektywą 2014/53/UE, SI 2017/1206.
Pełny tekst deklaracji zgodności UE/UK jest dostępny pod następującym adresem internetowym:
- Portuguese (PT) O(a) abaixo assinado(a) Furuno Electric Co., Ltd. declara que o mencionado acima tipo de equipamento de rádio está em conformidade com a Diretiva 2014/53/UE, SI 2017/1206.
O texto integral da declaração de conformidade da EU/UK está disponível no seguinte endereço de Internet:
- Romanian (RO) Prin prezenta, Furuno Electric Co., Ltd. declară că echipamentul radio menționat mai sus este în conformitate cu Directiva 2014/53/UE, SI 2017/1206.
Textul integral al declarației de conformitate UE/RU este disponibil la următoarea adresă internet:
- Slovak (SK) Furuno Electric Co., Ltd. týmto vyhlasuje, že vyššie spomínané rádiové zariadenie typu je v súlade so smernicou 2014/53/EÚ, SI 2017/1206.
Úplné EÚ/SK vyhlásenie o zhode je k dispozícii na tejto internetovej adrese:
- Slovenian (SL) Furuno Electric Co., Ltd. potrjuje, da je zgoraj omenjeno tip radijske opreme skladen z Direktivo 2014/53/EU, SI 2017/1206.
Celotno besedilo izjave EU/ZK o skladnosti je na voljo na naslednjem spletnem naslovu:
- Finnish (FI) Furuno Electric Co., Ltd. vakuuttaa, että yllä mainittu radiolaitetyyppi on direktiivin 2014/53/EU, SI 2017/1206 mukainen.
EU/UK-vaatimustenmukaisuusvakuutuksen täysimittainen teksti on saatavilla seuraavassa internetosoitteessa:
- Swedish (SV) Härmed försäkrar Furuno Electric Co., Ltd. att ovan nämnda typ av radioutrustning överensstämmer med direktiv 2014/53/EU, SI 2017/1206.
Den fullständiga texten till EU/Storbritannien-försäkran om överensstämmelse finns på följande webbadress:

Online Resource

http://www.furuno.com/en/support/red_doc

Notice for radiated immunity

The test for the radiated immunity is performed up to 2.7 GHz only without the special condition of spot frequency being applied. There is a chance that this equipment may interfere with allocated services in the frequency range of 2.7 GHz to 6 GHz, particularly in harbors, rivers, lake banks, etc.